The background is a vibrant red color. It features several abstract geometric shapes: a large teal semi-circle in the top-left corner, a blue semi-circle in the top-right corner containing a white circle, a dark blue horizontal bar in the top-right corner, a teal semi-circle in the bottom-right corner, and a blue semi-circle in the bottom-left corner containing a white circle. There are also smaller white circles and shapes in the bottom-left and bottom-right corners.

Appendix J1
Preliminary Design Report
Dodder Public Transportation
Opening Bridge

PRELIMINARY DESIGN REPORT - CONSULTATION

STA-1b

Scheme Name

Name and Location

Dodder Public Transportation Opening Bridge
River Dodder, Dublin

Structure(s)

Name and nature of the Structures(s)

1. Dodder Bridge
 2. Reclaimed land including Point Bridge south abutment foundation and slipway
 3. St Patrick's Rowing Club / Dublin City Council building
-

Preliminary Design Report

Reference

DPTB-ROD-C1-SWE-RPT-CV-00026-02

Revision

02

Date

January 2021

Submitted by

Signed



Name

Tony Dempsey

Position

Chief Bridge Engineer

(Team Leader)

Organisation

Roughan & O'Donovan

Date

25th January 2021

Structures Section confirmation of consultation:

Signed: -

Name: -

Position: -

Date: -

Dodder Public Transportation Opening Bridge Preliminary Design Report

TABLE OF CONTENTS

EXECUTIVE SUMMARY	1
Structure	1
Primary Function.....	1
Recommendations	2
Cost	2
1. INTRODUCTION	3
1.1 Instructions or Brief Given to the Authors, Including Dates.....	3
1.2 Background Information Covering the Origins for the Need for the Structure	4
1.3 Previous Studies and Their Recommendations.....	4
2. SITE & FUNCTION.....	5
2.1 Site Location	5
2.2 Function of the Structures	6
2.3 Choice of Location	6
2.4 Site Description and Topography	6
2.5 Vertical and Horizontal Alignments	7
2.6 Cross Sectional Dimensions on the Alignments	8
2.7 Existing Underground and Overground Services and Proposed Services	9
2.7.1 Existing.....	9
2.7.2 Proposed.....	11
2.8 Hydrology and Hydraulic Summary.....	11
2.9 Archaeological Summary	12
2.10 Environmental Summary.....	12
2.10.1 Environmental Impact Assessment (EIA).....	12
2.10.2 Existing Surveys.....	14
2.10.3 Recommended Surveys	14
2.10.4 Environmental Impact Assessment of the Proposed Structures and Mitigation.....	14
3. STRUCTURE & AESTHETICS	16
3.1 General Description of Recommended Structure and Design Working Life.....	16
3.2 Aesthetic Considerations	17
3.3 Proposals for the Recommended Structure	20
3.3.1 Proposed Category.....	20
3.3.2 Span Arrangements.....	20
3.3.3 Minimum Headroom	21
3.3.4 Approaches Including Run-on Arrangements	21
3.3.5 Foundation Type	21
3.3.6 Substructure	22

3.3.7	Superstructure.....	23
3.3.8	Articulation Arrangements, Joints, and Bearings	25
3.3.9	Vehicle Restraint System (Bridge, East and West Approach Retaining Walls, Reclaimed Land).....	26
3.3.10	Drainage.....	27
3.3.11	Durability	27
3.3.12	Sustainability	28
3.3.13	Inspection and Maintenance.....	29
3.3.14	Materials and Finishes.....	30
3.4	Light Rail Requirement	32
3.5	M&E Installation in Moveable Structures.....	33
3.6	Slipway Requirements	33
4.	SAFETY.....	34
4.1	Traffic Management During Construction.....	34
4.2	Safety During Construction	34
4.3	Safety in Use	35
4.3.1	Ship Impact Protection	35
4.3.2	Lifting Span in Operation	36
4.3.3	Changes in Bridge Use.....	36
4.3.4	Bridge Deck & Approach Environment.....	36
4.3.5	Bridge Traffic – Road, Cycle and Pedestrian	36
4.3.6	Bridge Traffic – Light Rail	36
4.4	Lighting.....	37
5.	COST.....	38
5.1	Budget Estimate	38
5.2	Cost Estimate Background.....	38
5.3	Basis of Cost Estimate.....	38
6.	DESIGN ASSESSMENT CRITERIA	39
6.1	Actions.....	39
6.1.1	Permanent Actions	39
6.1.2	Snow, Wind and Thermal Actions.....	39
6.1.3	Actions Relating to Normal Traffic	40
6.1.4	Actions Relating to Abnormal Traffic.....	40
6.1.5	Footway Live Loading.....	40
6.1.6	Provision for Exceptional Abnormal Loads	40
6.1.7	Accidental Actions	40
6.1.8	Actions During Construction	40
6.1.9	Any Special Loading Not Covered Above	41
6.1.9.1	Light rail (Luas).....	41
6.1.9.2	Bascule Bridge	41
6.1.9.3	Footway / Cycle Track Service Vehicle.....	41
6.1.9.4	Fatigue Load Model.....	41
6.1.9.5	Actions on Pedestrian Parapets.....	42

6.1.9.6	Load Model for Abutments and Walls Adjacent to Bridges.....	42
6.1.9.7	Flood / Water Loading	42
6.1.9.8	Assessment of Groups of Traffic / Rail Loads (Characteristic Values of the Multicomponent Actions)	42
6.2	Authorities Consulted and Any Special Conditions Required	42
6.3	Proposed Departures from Standards.....	44
6.3.1	Departure 1 – Vehicular Restraint System.....	44
6.3.2	Departure 2 – Main Structural Members of the Bridge Acting as Vehicle Parapets.....	44
6.3.3	Departure 3 – Use of BS 5400-10 for Fatigue Investigation Under RL Loading	45
6.3.4	Departure 4 – Reduced Width of Rubbing Strip.....	45
6.4	Proposed Methods of Dealing With Aspects Not Covered by Standards.....	45
7.	GROUND CONDITIONS	47
7.1	Geotechnical Classification.....	47
7.2	Description of the Ground Conditions and Compatibility With Proposed Foundation Design.....	47
7.2.1	Soil properties	47
7.2.2	Bedrock Conditions	48
7.2.3	Groundwater.....	48
7.2.4	Describe the Proposals for the Foundations	48
8.	DRAWINGS AND DOCUMENTS	49
8.1	List of all Documents Accompanying the Submission	49
8.2	Other Documents.....	50
APPENDIX 1	PHOTOGRAPHS	
APPENDIX 2	DRAWINGS	
APPENDIX 3	RELEVANT EXTRACTS FROM GROUND INVESTIGATION REPORT	
APPENDIX 4	OTHER RELEVANT DOCUMENTATION / REPORTS	
APPENDIX 5	MEICA TECHNICAL DETAILS	
APPENDIX 6	HYDRAULIC REPORT AND SECTION 50 APPLICATION	
APPENDIX 7	COST ESTIMATE BASE INFORMATION	
APPENDIX 8	ST PATRICK’S ROWING CLUB FEASIBILITY REPORT	
APPENDIX 9	SEA ACCESS OPTIONS FOR ST. PATRICK’S ROWING CLUB – TECHNICAL NOTE	
APPENDIX 10	RIVER DODDER PUBLIC TRANSPORT OPENING BRIDGE – MARITIME IMPACT ASSESSMENT	

EXECUTIVE SUMMARY

Structure

Dublin City Council have commissioned a preliminary design study for a new public transport corridor between Sir John Rogerson's Quay and the East Link Toll Bridge Junction. The scheme involves crossing the River Dodder adjacent to the Capital Docks development, which is currently under construction.

A preliminary design which is both functional and architecturally sensitive to the urban environment has been developed.

The site and associated constraints have been thoroughly examined as outlined in Chapter 2 and 4.

The developed preliminary design structures are described in Chapter 3. The new St. Patrick's Rowing Club and Dublin City Council Building are detailed in Appendix 4. The associated cost estimates, including whole life costs, are included in Chapter 5.

Chapter 6 and 7 detail the design assessment criteria and ground conditions used in the preliminary design process and will be advanced in the detailed design process.

There are broadly three structures detailed within this preliminary design report that make up the overall Dodder Public Transportation Opening Bridge scheme. The structures are as follows:

1. Dodder Bridge
2. Reclaimed land pile supported slab including the Point Bridge south abutment foundation and slipway
3. St Patrick's Rowing Club / Dublin City Council building

The Point Bridge is a proposed pedestrian and cycle bridge over the River Liffey adjacent to the western edge of the Tom Clarke (East-Link) Bridge. Its arrangement and form are under development under a separate scheme, however it is proposed that the southern abutment's foundation of piles and pile cap are located on the reclaimed land and is constructed as part of this scheme.

This report describes all the above structures and provides associated preliminary design information for the heavy civil engineering structures: the bridge and reclaimed land. The St. Patrick Rowing Club / Dublin City Council building is detailed in Appendix 4 and the drawings provided in Appendix 2. Details of the public realm area are specified in the architect's drawings, included in Appendix 2, and are otherwise not detailed in this structural preliminary design report.

Primary Function

The primary function of this scheme is to provide public transportation over the Dodder river at its confluence with the River Liffey in Dublin's Docklands. The Dodder Bridge structure shall provide public road carriageway, cycle tracks, and footways. This shall allow interconnectivity of bus, cycle, and pedestrian networks over the River Dodder. The bridge is designed and detailed to be adapted to carry light rail (Luas) in the future.

The whole site, including on the reclaimed land, will become public realm. This will include minor, non-trafficked structures, landscaping, and planting such as terracing, steps, and planters.

Recommendations

Recommendation for the structures of the overall Dodder Public Transportation Opening Bridge scheme is provided below. Plans, elevations, and cross sections for the recommended structures are provided in Appendix 2.

The developed bridge arrangement of a bascule bridge with the main bascule operating machinery and counterweight housed in a pier in the river was selected at a previous design stage, recorded in report reference DPTB-ROD-C1-SWE-RPT-CV-00005 Revision 06 May 2019. The road alignment and junction to the Tom Clarke Bridge was developed in report reference DPTB-ROD-C1-SWE-RPT-CV-00025 Revision 03 June 2019 and an option selected including: no right turn from the Tom Clarke Bridge onto the Dodder Bridge; and an access to the St Patricks Rowing Club to the west of this junction. At this preliminary design stage, the key items which have developed and are recommended for inclusion are:

- A bascule bridge with a fixed counterweight.
- Use of bored, cast-in situ foundation piles socketed into bed rock.
- Positioning of the new Dublin City Council Bridge Control Room / St Patrick's Boat Club.
- A jetty slope along the Liffey facing bank of the reclaimed land.

The proposed preliminary design structural arrangement are as follows:

1. Dodder Bridge – orthotropic steel superstructure over the River Dodder including an opening bascule span. Substructure shall be in-situ reinforced concrete supported by bored cast-in-place concrete foundation piles. The west abutment wingwall includes a short section of back to back retaining walls supporting the road onto Sir John Rogerson's Quay (west).
2. Reclaimed land including:
 - a. a piled supported slab bounded by a sheet piled wall on the river sides to form the east approach to the bridge and surrounding land, including over the Liffey service tunnel and to accommodate the St Patrick's Rowing Club.
 - b. Point Bridge south abutment foundation: piles and pile cap.
 - c. Slipway to provide access for boats on trailers from the reclaimed land to the River Liffey.
 - d. The east approach retaining walls cast integrally with the piled slab which abuts the east abutment bridge wingwalls. The east retaining wall support the road over the reclaimed land (east).
3. Dublin City Council Bridge Control Room / St Patrick's Rowing Club building – a two-story multi-use steel-framed structure facing the River Liffey, constructed on the reclaimed land.

Cost

In addition to the design development detailed in this preliminary design report, the Designer carried out a preliminary cost estimate where initial construction costs, administration costs, land costs, and life cycle costs were developed for the scheme. The total cost estimate including VAT is detailed in the Cost Estimate Report.

The preliminary cost estimate has been prepared in accordance with the "*Cost Management Guidelines for Projects funded by the National Transport Authority*", September 2019. A separate Cost Estimate Report in accordance with these procedures has been prepared.

1. INTRODUCTION

1.1 Instructions or Brief Given to the Authors, Including Dates

Roughan & O'Donovan Ltd. was commissioned by Dublin City Council to undertake the engineering consultancy services including the planning, option studies, design, preparation of EIA / EIAR, and statutory process for the Dodder Public Transportation Opening Bridge scheme. The scheme involves crossing the River Dodder adjacent to the Capital Docks development, which is currently under construction.

Roughan & O'Donovan Ltd. were assisted by specialist sub-consultants Hardesty and Hanover on the MEICA design of the moveable bascule bridge and Sean Harrington Architects on the building and bridge architectural design including public realm landscaping.

The project is divided into 5 stages (Capital Works Management Framework Stages 1 to 5) as follows:

- Stage 1 – Outline Scheme Design and Options Study
- Stage 2 – Design
 - Stage 2(a) - Preliminary Design and Site Investigation
 - Stage 2(b) – Planning and Public Consultation
 - Stage 2(c) – Detailed design
- Stage 3 – Tender
- Stage 4 – Construction
- Stage 5 – Handover of Works

This report relates to the Preliminary Design Report which is the main deliverable as defined in the Stage 2 Services of the DCC project brief (Volume 3.1 Service Requirements).

Throughout the preliminary design, all aspects of the brief have been considered. The Consultant's brief included the delivery of the following objectives:

- The main objective of the project is to provide an architecturally sensitive opening bridge over the mouth of the River Dodder;
- Provide a control building for the operation of the proposed Dodder Bridge (which may also be used to operate the Tom Clarke Bridge) & St. Patrick's Rowing Club building and facilities which are architecturally sensitive with the surrounding site constraints in an optimum location;
- Provide a bridge suitable for future public transportation requirements such as Light Rail, Bus Corridors, cycleways and high-quality pedestrian facilities; particularly, safe and convenient road crossings;
- Establish the optimum layout, structural, hydraulic and environmental project requirements;
- Provide a safe and compatible tie-in junction to the existing road network taking into consideration level changes around the Liffey Service Tunnel Access Shaft;
- Take account of all relevant proposals for development and infrastructure in the vicinity of the project.

The proposed Dodder Bridge is in a busy urban location and waterway navigation throughout construction will need to be maintained. These are key factors affecting constructability and design.

Completed in November 2017, Roughan & O'Donovan on behalf of Dublin City Council undertook an options study as part of the National Transport Authority PMG Phase 1 for the project. Roughan & O'Donovan supported Dublin City Council during public consultation events on the bridge in February and March 2019.

This report details the structural, geotechnical, mechanical, and electrical technical elements of the opening bridge itself for Dublin City Council ahead of the detailed design process. This report format is outlined in principle with Transport Infrastructure Ireland's document no. DN-STR-03001 "Technical Acceptance of Road Structure on Motorways and Other National Roads" dated April 2019 for a preliminary design report.

1.2 Background Information Covering the Origins for the Need for the Structure

Dublin City Council identified the need for a bridge to improve access for pedestrians, cyclists and public transport between the Poolbeg Peninsula and the city centre in the North Lotts and Grand Canal Dock SDZ. The transport link provided by the bridge also supports development of the proposed Poolbeg West Strategic Development Zone (SDZ).

1.3 Previous Studies and Their Recommendations

An options study report was undertaken in 2017, updated in 2019, by Roughan & O'Donovan on behalf of Dublin City Council. This is recorded in DPTB-ROD-C1-SWE-RPT-CV-00005 revision 6, issued May 2019. The exercise considered one fixed bridge option, and four opening bridge options. The preferred option was for a bascule opening bridge with the bascule pier located in the river.

The road alignment and configuration of the eastern junction of the bridge to the existing road network was further developed in the report DPTB-ROD-C1-SWE-RPT-CV-00025 revision 3, issued June 2019. The report identified two feasible options. The chosen option has a new junction between the Dodder Bridge's east approach road and the southern end of the R131 Tom Clarke Bridge. There is no provision of a right-hand turn for traffic heading south over the Tom Clarke Bridge onto the proposed Dodder Bridge. Access to the proposed St Patrick's Rowing Club building is from an at-grade junction to the new road on the east approach.

Roughan & O'Donovan conducted an Appropriate Assessment screening exercise in 2018. This is recorded in the report DOB-ROD-EBD-SW_AE-RP-EN-4001 revision 01 and summarised in section 2.10.4 of this report. It found that two special protection areas could be affected by the bridge. It was recommended that a Natura Impact Statement (NIS) is prepared. The NIS (currently being progressed by ROD on behalf of DCC) will provide An Bord Pleanála with the information required to complete an Appropriate Assessment in respect of the proposed development.

As a development situated partly in the foreshore, the proposed development has also screened in for Environmental Impact Assessment (EIA) under Section 226 of the Planning & Development Act 2000. The EIA Report (currently being progressed by ROD on behalf of DCC) will provide An Bord Pleanála with the information required to complete the EIA in respect of the proposed development.

2. SITE & FUNCTION

2.1 Site Location

The bridge is located over the River Dodder at its confluence with the Liffey. Immediately to the south of the bridge is the Grand Canal Dock. The proposed road runs roughly east-west to connect with the Liffey's south bank: Sir John Rogerson's Quay to the west at Britain Quay, connecting to the R131 at the east. Immediately east of the site is the existing Tom Clarke bridge carrying the R131 over the River Liffey.



Figure 2.1 Site Plan

This development of the Docklands ends at Sir John Rogerson's Quay which is currently the eastern dead end of the long stretch of south quays as shown in Figure 2.1 and 2.2. The new bridge will provide a threshold and gateway between the dockland's development and Ringsend and the Poolbeg peninsular beyond.



Figure 2.2 Site Maps

At its western end, the bridge spans over the Britain Quay wall to bear onto an abutment located behind the quay wall. At the east, the abutment is on an area of reclaimed land, over which the road is carried on an embankment and back-to-back retaining walls. The reclaimed land spans over Dublin City Council's Liffey services tunnel and a high-pressure gas main. A new slipway for Rowing Club use is provided

and the existing Rowing Club floating jetty relocated. The proposed Point Bridge's south abutment is constructed on the reclaimed land as part of this project.

Site location plans are included in Appendix 2.

2.2 Function of the Structures

The primary function of the structures is to provide bus, pedestrian and cyclist connectivity over the River Dodder. The structures shall be designed to accommodate light rail (Luas) in the future. The River Dodder is navigable and therefore the Dodder Bridge necessitate a movable span. The new building, located on the reclaimed land, is constructed for the shared use of St Patrick's Rowing Club and as a bridge control room for Dublin City Council.

2.3 Choice of Location

The general road alignment and location of the structure was produced by Dublin City Council to facilitate continuity along the line of the south bank of the River Liffey. The Options Study considered a road alignment which limited the quantity of reclaimed land required by orientating the road from Britain / Sir John Rogerson's Quay south-eastwards towards Thorncastle Street. However, a road alignment running parallel with the Liffey was selected such that the south bank of the Liffey runs in a straight line from Sir John Rogerson's Quay onto the bridge, in order to meet navigational clearance and flood protection levels.

2.4 Site Description and Topography

The site is located in an urban environment in an area of historic docklands which have been regenerated as an area of mixed high-rise offices and flats.



Figure 2.3 Site Aerial Photograph – Urban Environment

The site is generally flat. To the west, the existing ground level of approximately 3.1 mOD is retained by the Britain and Sir John Rogerson's Quay walls. To the east, a grassed area falls from the R131 approach to the Tom Clarke bridge at around 4.5 mOD down to the riprap bank of the Dodder/Liffey. Reclaimed land in this eastern area is built up to 4.15 mOD.



Figure 2.4 Site Urban Environment and Topography

The River Dodder is tidal at the bridge location. The following tidal levels and flood defence levels are incorporated in the design:

- +4.15 mOD city flood defence level
- +3.25 mOD design flood level (200-year return period)
- +1.99 mOD highest astronomical tide
- +1.59 mOD mean high water springs (MHWS)
- +0.89 mOD mean high water neap
- -1.11 mOD mean low water neap
- -1.81 mOD mean low water springs (MLWS)
- -2.71 mOD lowest astronomical tide

Photographs and location maps are shown in Appendix 1 and 2, respectively.

2.5 Vertical and Horizontal Alignments

The design speed for road traffic over the bridge is 30 km/h.

A summary of horizontal and vertical mainline road alignments is provided in Table 2 around the Dodder Bridge and its approaches.

Table 2.1 Horizontal and Vertical Alignments

Element	Alignment	Western Approach (Chainage 0+046 to 0+082)	Bridge Crossing (Chainage 0+082 to 0+172)	Eastern Approach (Chainage 0+172 to 0+190)	Eastern Approach (Chainage 0+190 to 0+215)
Proposed Mainline	Horizontal	Straight	Straight	Straight	Straight
	Vertical	Linear Gradient 5%	Crest curve, K-value = 9	Linear Gradient 5%	Sag curve, K-value = 5

For full details of the horizontal and vertical alignments see the drawings in Appendix 2.

2.6 Cross Sectional Dimensions on the Alignments

The proposed cross section at the bridge structure is shown in Table 2.2. Explanations of the widths chosen for the various sections are outlined below.

Table 2.2 Proposed Mainline Cross Section at Dodder Bridge

Proposed Cross Section	Width (m)
North Parapet Edge Beam	0.50
North Footpath	2.50
North Cycle Tracks	3.00
North Upstand	0.60
North Rubbing Strip	0.50
North Carriageway Lane	3.25
South Carriageway Lane	3.25
South Rubbing Strip	0.50
South Upstand	0.60
South Footpath	5.50
South Parapet Edge Beam	0.50

The total typical width of the bridge is 20.7m with localised widening outstands at the bascule pier support for public realm purposes. Running off the bascule and central span, the 0.5 m wide raised rubbing strip and 0.6 m upstand box girder forms a 1.1 m width provision between the carriageways and footpath / cycle track. This 1.1 m width provision tapers to 0.0 m over the length of the west and east approach. The justification for the reduced 0.5m rubbing strip at the bascule and central span is detailed in Section 6.3.4.

Within each carriageway lane is provision for installation of a light rail (Luas) track of 1.435 m gauge, 3.3 m between centrelines of the tracks.

The River Dodder under the opening span shall have a navigational width of 19 m of unrestricted headroom when the bridge is in the fully raised position of 70 degree rotation, and navigational headroom to 2.7 m above MHWS (i.e. a soffit at a minimum +4.29 mOD) when closed. The navigational channel is to have draught below MLWS of at least 2.1 m (i.e. channel bed lower than -3.91 mOD).

2.7 Existing Underground and Overground Services and Proposed Services

2.7.1 Existing

A detailed utilities survey of the bridge site was carried out in August 2017. This comprised of plotting underground utilities from all available utilities record data in combination with a geophysical survey of the site to corroborate the record data as far as practicable. Details of the existing services are provided in Appendix 2.

Due to the presence of temporary site cabins and ongoing construction at the Capital Dock site, access to the bridge landing site at Britain Quay was not feasible. At the time of survey, the location was a building site with Contractors Cabins. As built services survey was subsequently provided from Kennedy Wilson in October / November 2019 for this area. The topographic survey around the Capital One site was never completed.

No overground services have been highlighted.

Sir John Rogerson's Quay/Britain Quay

These services are either existing or under construction/diverted as part of the Capital Dock development:

- Gas mains (including a distribution pipe [medium pressure] which crosses the Liffey and enters through the quay wall onto Sir John Rogerson's Quay, before travelling down Liffey's southern bank)
- Water mains
- Surface water drainage
- Telecom/Eir
- ESB underground (medium voltage / low voltage)

Dodder River

There are no existing services in the vicinity of the site. However, there are proposed Dublin District Heating Supply pipes to be installed across the River Dodder, parallel to the bridge.

Ringsend Site / Thorncastle St. / York Road / R131

There are three services tunnels / pipelines buried at depth under the proposed reclaimed land area carrying services under the River Liffey.

1. Liffey Service Tunnel

The Liffey Service Tunnel was built between 1925 and 1928 and runs directly underneath the Tom Clarke Bridge, the proposed east approach road and the eastern edge of the proposed reclaimed land. It is 253 m long, 2.2 m diameter, of precast concrete pipe units and falls at 1-in-400 from south to north. The southern access shaft at the junction of York Road and Thorncastle Street in Ringsend has internal diameter 3.35 m and is of cast iron rings lined with concrete. Located. The tunnel carries electricity cables, a 24-inch water main and the 15-inch East Road-Ringsend rising main.

2. Gas Networks Ireland Pipeline

A 193 m long, 500 mm diameter high pressure gas line is located parallel to the Tom Clarke Bridge. It runs underneath the proposed east approach road, reclaimed land and Dublin City Council / St Patrick's Rowing Club building. The pipe is located 5.8 m below the navigable channel. Its 9 m ID southern access shaft is wholly buried, with a

concrete roof slab at 3.2 mOD (approximately 1.2 m below ground level). Its access manhole is in front of the existing St Patrick's Rowing Club building and is shared with the 2008 Service Tunnel (see below). From the shaft, the gas main runs under York Road parallel to the Liffey in a shallow trench.

3. 2008 Service Tunnel

In 2008, a third tunnel was constructed under the River Liffey. It passes underneath the proposed east approach road, reclaimed land and jetty. The tunnel is approximately 8m below the navigable channel and is 260 m long with a 3 m external diameter constructed using the pipe jacking method. Southern access to the service tunnel is provided via the Gas Networks Ireland pipeline access shaft. The tunnel carries:

- 600 mm water main
- 2 No 500 mm rising mains
- ESB underground HV
- 630 mm and 710 mm OD district heating pipes
- Telecoms: may include Eir, Novogen, BT Ireland, E-net, Virgin Media, Colt Technology and Vodafone.
- Tunnel services including a ventilation duct, lighting, and drainage.

The above services all exit the south services shaft. Also, under the reclaimed land are:

- Water mains
- Foul water
- Telecom/Eir
- ESB underground MV/LV
- Novogen.



Figure 2.5 Service Tunnel Interface at the Ringsend Site

2.7.2 Proposed

The reclaimed land and bridge abutments piles have been arranged so as not to clash with the buried tunnels / pipeline. However, striking or disturbing them remains a critical construction risk. The gas main, Novogen and District Heating pipes exiting the Liffey Services Tunnel requires protection for construction of the bridge east approach.

For the west approach it is anticipated that the Gas (125mm diameter), Telecom/Eir and ESB services will require diversions to facilitate the construction of the bridge and its western approach roadway construction.

Dublin District Heating Supply pipes are proposed to pass under the River Dodder, parallel to the bridge in a future scheme.

The Dublin City Council / St Patrick's Rowing Club building is be serviced by gas, electricity, telecoms, water, and sewerage. These services are buried in the fill above the reclaimed land slab to connect with existing local networks. A dedicated electrical and telecoms link forming part the new bridge's infrastructure is provided from the building to the west bascule pier.

Electrical power for the bridge infrastructure at the western end is taken from local networks.

2.8 Hydrology and Hydraulic Summary

In order to assess the impact of the proposed bridge structure on flooding and flood levels, a 1-D HEC RAS hydraulic model of the Dodder and Liffey was developed using the CFRAM Liffey survey, the Dodder channel Survey from the Flood relief study, a recent bathymetric survey carried out by Aquafact of the Dodder-Liffey Confluence area, Liffey Estuary Bathymetric surveys that were obtained from Dublin Port and surveys undertaken by Aquafact in 2019 within Dublin Bay.

The critical design flood events are the present day and future climate change combined 200-year flood event as follows:

- Simulation 1 Present day 100-year Dodder Fluvial Flood Flow of 311.2cumec with tidal flood level of 2.65m OD (9-year tidal event)
- Simulation 2 Present day 4.5-year Dodder Fluvial Flood Flow of 136.5cumec with 200-year tidal flood level of 3.07m OD
- Simulation 3 Future 100-year Dodder Fluvial Flood Flow of 373.4cumec with tidal flood level of 3.3m OD (9-year tidal event)
- Simulation 4 Future 4.5-year Dodder Fluvial Flood Flow of 163.8cumec with 200-year tidal flood level of 3.62m OD

The predicted medium range future emission design flood event produces a peak flood level at the proposed bridge site of 3.628mOD. The Soffit levels of the bridge varies from a minimum level of 4.15 to a maximum level of 5.45m OD providing clearances above the future design flood level of 0.52 (at the eastern abutment) to 1.82m (mid span).

At critical peak flood levels the predicted upstream afflux from the proposed bridge structure is small at less than 1cm for the 200year Storm surge tidal event combining with 4.5year fluvial event. The high Fluvial Flood flow events generate the higher afflux with the 100year fluvial flow generating 4.2 and 4.7cm at high tide.

The maximum afflux is generated under the 100year fluvial flood conditions in the Dodder and at Low water (i.e. when the tide is fully out). The predicted Low water under such conditions without the Bridge is -2.013 and -1.398 for the present and future cases and with the bridge the predicted low water flood levels are -1.349 and -0.798m OD.

The Office of Public Works has been contacted and consent from the Commissioners of Public Works under Section 50 of the Arterial Drainage Act, 1945 has been obtained. A copy of the Section 50 Application and the associated hydraulic report is included in Appendix 6.

In relation to hydrology, the drainage of the various elements of the proposed bridge deck will be discharged to existing surface water sewers. It is not proposed to discharge any surface water from the deck directly into the river due to the additional pollutant risks being collected from passing vehicular traffic.

2.9 Archaeological Summary

The proposed bridge location is very important to the City of Dublin from a historical context and in terms of cultural heritage. Various studies are required to be carried out, under the Environmental Impact Statement, into the prospects for archaeological discovery during bridge construction.

The existing quay walls at the site are protected structures, and the Campshires (strips of land between the road and the quay walls) are of historical importance.

Dublin city centre quays have been sites of great archaeological importance in the past, such as the Wood Quay excavations of the 1970's and 1980's. There is potential for the discovery of other Viking or medieval artefacts during the construction of the proposed bridge.

There is a historic connection between Ringsend, the sea and the docks, which included a boat building tradition along the banks of the River Dodder. It is important that the physical connection with, and views of, the River Dodder and the River Liffey be continued.

The west abutment bankseat accommodates the protected Britain Quay walls by cantilevering out from new piled foundations installed behind the wall.

2.10 Environmental Summary

2.10.1 Environmental Impact Assessment (EIA)

A review of the relevant legislation including Directive 2011/92/EU (as amended by Directive 2014/52/EU) and European Communities (Environmental Impact Assessment) Regulations (1989) has identified that completion of an EIA is a mandatory requirement for the proposed bridge development. The proposed development does not meet the thresholds for which the preparation of an EIAR is a mandatory requirement under Schedule 5 of the *Planning and Development Regulations 2001 – 2019* or Section 50 of the *Roads Act 1993 (as amended)*. However, the proposed development includes construction of structures in the foreshore. Therefore, Section 226 of the *Planning and Development Act 2000* is applicable:

*“Where development is proposed to be carried out wholly or partly on the foreshore—
(a) by a local authority that is a planning authority, whether in its capacity as a planning authority or otherwise, or*

(b) by some other person on behalf of, or jointly or in partnership with, a local authority that is a planning authority, pursuant to an agreement entered into by that local authority whether in its capacity as a planning authority or otherwise [...] [...] Section 175 shall apply to proposed development belonging to a class of development, identified for the purposes of Section 176”

Further, Section 175 of the *Planning and Development Act 2000* stipulates that:

“Where development belonging to a class of development, identified for the purposes of Section 176, is proposed to be carried out—

(a) by a local authority that is a planning authority, whether in its capacity as a planning authority or in any other capacity, or

(b) by some other person on behalf of, or jointly or in partnership with, such a local authority, pursuant to a contract entered into by that local authority whether in its capacity as a planning authority or in any other capacity, within the functional area of the local authority concerned (hereafter in this section referred to as “proposed development”), the local authority shall prepare, or cause to be prepared, an environmental impact statement [EiAR] in respect thereof.”

Therefore, preparation of an EiAR for submission as part of the planning application to An Bord Pleanála is a mandatory requirement for the proposed development.

The scoping stage of the EIA has been completed. In January 2018, an Informal Scoping Document was issued for comment to over 30 statutory and non-statutory consultees. Responses subsequently received are informing the ongoing development of the EiAR.

Relevant specialists will compile content for the EiAR. The report will identify the likely significant effects of the proposed development, alone and in combination with other plans / projects, in respect of the following aspects of the environment:

- Traffic and transportation
- Population and human health
- Biodiversity
- Soils and geology
- Hydrogeology
- Hydrology
- Landscape and visual amenity
- Noise and vibration
- Air quality and climate
- Archaeology and cultural heritage
- Architectural heritage
- Material assets and land
- Major accidents and natural disasters.

If significant environmental impacts are identified, appropriate corresponding mitigation measures shall be prescribed. The measures will aim to eliminate negative impacts or reduce the magnitude of negative impacts to levels that are not considered significant.

Appropriate assessment

Appropriate Assessment (AA) is an environmental assessment undertaken as part of compliance with article 6(3) of the Habitats Directive and aligned with guidance from

the Department of Environment, Heritage and Local Government, 2009. Roughan & O'Donovan undertook an Appropriate Assessment screening report in 2019 (see section 1.3). The screening report identified two Natura 2000 sites with potential to be affected by the bridge: The South Dublin Bay and River Tolka Estuary Special Protection Area (SPA), and the North Bull Island SPA. Both sites are designated for the protection of wild birds. The screening report concluded that the proposed bridge development *"is likely to give rise to impacts which would constitute significant effects on [these] two European sites [...] in view of their Conservation Objectives"*. As such, a Natura Impact Statement (NIS) will need to be prepared, to provide An Bord Pleanála with the information required to complete an Appropriate Assessment for the proposed development. The NIS shall be prepared by ROD and will examine, analyse, and evaluate the implications of the proposed bridge development, making appropriate recommendations for these implications. The NIS will consider the implications on the two sites of the bridge both individually and in combination with other plans / projects.

2.10.2 Existing Surveys

For the purposes of the EIA and AA, the following surveys have been completed:

- Multidisciplinary ecological walkover survey
- Ornithological surveys (wintering birds and tern)
- Habitat mapping
- Invasive alien plant species survey
- Bat activity surveys
- Otter survey
- Badger survey
- Underwater archaeological survey
- Archaeological / cultural heritage walkover
- Architectural heritage walkover

2.10.3 Recommended Surveys

The following ongoing or to be commenced surveys are necessary for the completion of the EIA and AA:

- Water quality monitoring
- Benthic assessment surveys
- Baseline noise and vibration survey
- Hydrodynamic modelling
- Traffic modelling

2.10.4 Environmental Impact Assessment of the Proposed Structures and Mitigation

As discussed above, the environmental assessments for the proposed development are not completed. Preliminary findings of desk research and field surveys for the purposes of these environmental assessments have identified the following key potential impacts, which will be addressed in the EIAR and / or NIS.

Construction – adverse impacts

- Surface water pollution from improper management / disposal of contaminated land which has been identified within the site of the proposed development.
- Accidental emission of pollutant-containing run-off to surface water (including sediment loading).

- Dispersal / introduction of invasive alien species and associated ecological impacts.
- Loss of mudflat habitat because of land reclamation.
- Adverse hydroacoustic impacts on certain species of fish as a result of certain aspects of proposed works including piling.

Operation – adverse impacts

- Future risk of bird strikes as a result of overhead light rail (Luas) lines and, to a lesser degree, the bridge itself.
- Adverse changes to hydrodynamic / fluvial characteristics of one or both watercourses (Dodder and Liffey) as a result of the proposed piers in the River Dodder. This could have ecological (e.g. altered erosion / deposition regime downstream, including in Natura 2000 sites) and socioeconomic (e.g. increased likelihood of flooding) impacts.
- Exacerbation of existing traffic congestion on roads and bridges in the vicinity, including the East-Link Road and Tom Clarke Bridge, and associated adverse impacts (including poorer air quality, increased noise pollution and increased journey times)¹.
- Adverse effect of increased lighting on wildlife, especially bats.

General – positive impacts

- Improved connectivity for pedestrians, cyclists, public transportation (i.e. bus and light rail) and taxis between the South Quays and the Poolbeg Peninsular, and associated benefits for communities and businesses in the area.
- Facilitation of further development in the North Lotts and Grand Canal Strategic Development Zone (SDZ), including critical housing development.
- Improved facilities for St Patrick's Rowing Club.
- Positive visual effects in the surrounding environment.

¹ A number of other transport infrastructure projects are proposed for the vicinity of the proposed bridge, and careful consideration of potential cumulative impacts (particularly in respect of traffic) will be required.

3. STRUCTURE & AESTHETICS

This section does not include the Dublin City Council / St Patrick's Rowing Club building – refer to Appendix 2 and Appendix 4 for these details. Similarly, this section does not include the public realm – refer to details as shown on the architects drawing, see Appendix 2.

3.1 General Description of Recommended Structure and Design Working Life

The Dodder Bridge has three spans. The western span is a single leaf bascule opening span of length 33.0m. The central and east spans are continuous, 25.15m and 26.4m respectively. An 11.15 m length of bridge made up of the bascule top slab is between the western and central span. The bridge deck is approximately 20.7 m wide and carries a two-lane carriageway, cycle tracks on the north verge and footpaths to both sides. In normal operation, the bridge carriageway serves public transport only: initially just buses and taxis. However, the bridge is designed and includes details such that it could be readily converted, without significant structural works or modifications, to take two tracks of electrified light rail (Luas) as well. The superstructure is a painted steel orthotropic deck box with cantilever outstands. All spans are square (no skew).



Figure 3.1 Proposed Dodder Bridge (View from Thorncastle Street)

The bascule trunnion and counterweight backspan are contained within the west bascule pier in the river. A second, smaller slender pier in the river supports the central and east span via articulated bearings. The option of detailing a fixed connection, eliminating the bearing requirement, will be examined at the detailed design stage. The bascule span west abutment is a piled bankseat, founded behind the existing Britain Quay wall but cantilevering out over the top of the wall to support the bearing shelf. The east span abutment is on an area of land reclaimed as part of this scheme. All substructures shall comprise in-situ reinforced concrete construction on reinforced concrete piles. All proposed foundations are bored cast-in-place reinforced concrete piles, socketed into bedrock.

The reclaimed land is formed by a reinforced concrete slab, generally 500 mm thick on a square grid of piles at 6 m centres nominally. Locally, the slab is thickened to span over buried services, most notably the 2018 services tunnel and high-pressure gas main. The slab is bounded to the west and north by sheet piles which will form the new banks of the Dodder and Liffey, respectively. The slab typically has a 1% fall for drainage and is formed on top of a 100 mm blinding layer. The slab has up to approximately 1 m of 6N/6P fill placed on top of it. The landscape architecture finishes above the pile supported slab are detailed in Appendix 2: a variety of paving, pavement, and other landscaping features. The Dublin City Council / St Patrick's Rowing Club building is constructed on top of the slab along its northern edge, in front of which a reinforced concrete slipway is constructed.

The east approach to the bridge over the reclaimed land contains back-to-back approach in-situ retaining walls to retain the carriageway. The walls are reinforced concrete and are cast integrally with the reclaimed land pile supported slab. The west is similarly constructed with in-situ reinforced concrete. The west retaining wall will

take the form of L- or T-shaped gravity retaining walls founded on a layer of 500 mm thick 6N/6P.

The Point Bridge south abutment foundation is a reinforced concrete pile cap supported on bored piles located between the Dublin City Council / St Patrick's Rowing Club building and Tom Clarke Bridge. The top of pile cap level is the same as the surrounding reclaimed land slab. The Point Bridge is separate project and the details are to be developed. Accordingly, the final arrangement of the south abutment arrangement will be confirmed as bridge design requirements are finalised.

All permanent bridge elements, the slipway, reclaimed land structure (including approach retaining walls) and the Point Bridge south abutment are working life category 5 (≥ 120 years design working life).

The design working life of replaceable structural parts such as expansion joints, waterproofing systems, parapets and bearings other than main trunnion bearings shall be at least 25 years. In accordance with Table A1 of IAN 124/11 for the above replaceable structural parts shall be Category 2 and have an upper limit design working life of up to 50 years.

For details of the mechanical and electrical (M&E) plant/equipment and of its design working life, refer to the MEICA technical details in Appendix 5 of this document.

Drawings showing the general arrangement of the bridge and pile slab reclaimed land are included in Appendix 2.

3.2 Aesthetic Considerations

The city of Dublin has a proud history of technically advanced bridges. The project brief calls for a bridge which is architecturally sensitive to its surrounding infrastructure, such as the Samuel Beckett Bridge, Capital Dock development, Grand Canal Dock, Dublin City Quay Walls, Tom Clarke Bridge and the future Point Pedestrian & Cyclist Bridge.

The new Dodder Bridge, whilst being very different, shall be designed in the same spirit of forward-looking innovation of form, materials, and finishes. The bridge provides a practical and symbolic link between local areas of development and regeneration on both sides of the mouth of the Dodder. In addition, it shall play an important part in the wider transportation network around Dublin.

The integrated and coordinated arrangement of the bridge's architectural, structural, and urban design components shall give local travellers – bus passengers, pedestrians, and cyclists – separate and special visual experiences as they cross the bridge from old to new Dublin.

The bridge's simple structure and elegant form, floating above the water, addresses its context and setting. The design also confidently addresses the technical problems posed by the bridge's role as a critical transport link and as an opening structure. It shall provide some drama during the opening and yet illustrate simplicity in its form. The design shall be timeless and offer its own special characteristics to the landscape.

The engineering, traffic and existing site infrastructure requirements have to date dictated the requirement of an embankment on the east bank to serve the eastern approach road. This has been minimised with the access to the new rowing club provided by an at-grade crossing of the new road.

High quality finishes are instrumental in defining any landmark structure and the new Dodder Bridge will be finished to the very highest standards. The finishes will be demonstrative of the aspirations of the bridge and the surrounding area. A high-quality architectural lighting scheme will be incorporated and used to transform the night-time setting.

The span arrangement is dictated by minimising the length of the opening span across the deepest part of the Dodder's channel for a 19 m navigation width. The resulting 33 m span is near the upper end of an economic single leaf bascule. Whilst consideration at the options stage was given to positioning the bascule trunnion on Britain Quay, the resulting land take and excavation required was found to be unacceptable. As such, the bascule pier was placed in the river channel. To provide adequate structural depth for the bascule span without raising the vertical alignment to such an extent that a long approach along Sir John Rogerson's Quay would be provided, upstand girders are utilised between the carriageway and footpath / cycle track.

From the functional basis above, the following decisions which included aesthetic considerations were made:

- To split the bridge to the east of the bascule pier into two approximately equal spans to approximately match the span length of the bascule span.
- To wholly enclose the bridge deck in a smooth soffit plate.
- Integration of public realm on the bridge including the local deck widening at the bascule pier.
- The use of a constant height upstand girder. This gives the perception of structural continuity from the fixed spans onto the bascule span and provides hard segregation between pedestrians / cyclists and the road. This upstand and very shallow apparent structural depth echo the Rosie Hackett bridge design philosophy in this regard.
- Given the location of the bridge and its industrial heritage setting, the superstructure corrosion protection paint colour shall be to a distinctive vibrant orange/dark red to give an oxide finish effect of weathered/corten steelwork.
- To clad sheet piling to the reclaimed land in stone matching the existing quay walls.
- Piers are formed to a high-quality textured finish.



Figure 3.3 Palette of materials, texture, and colour

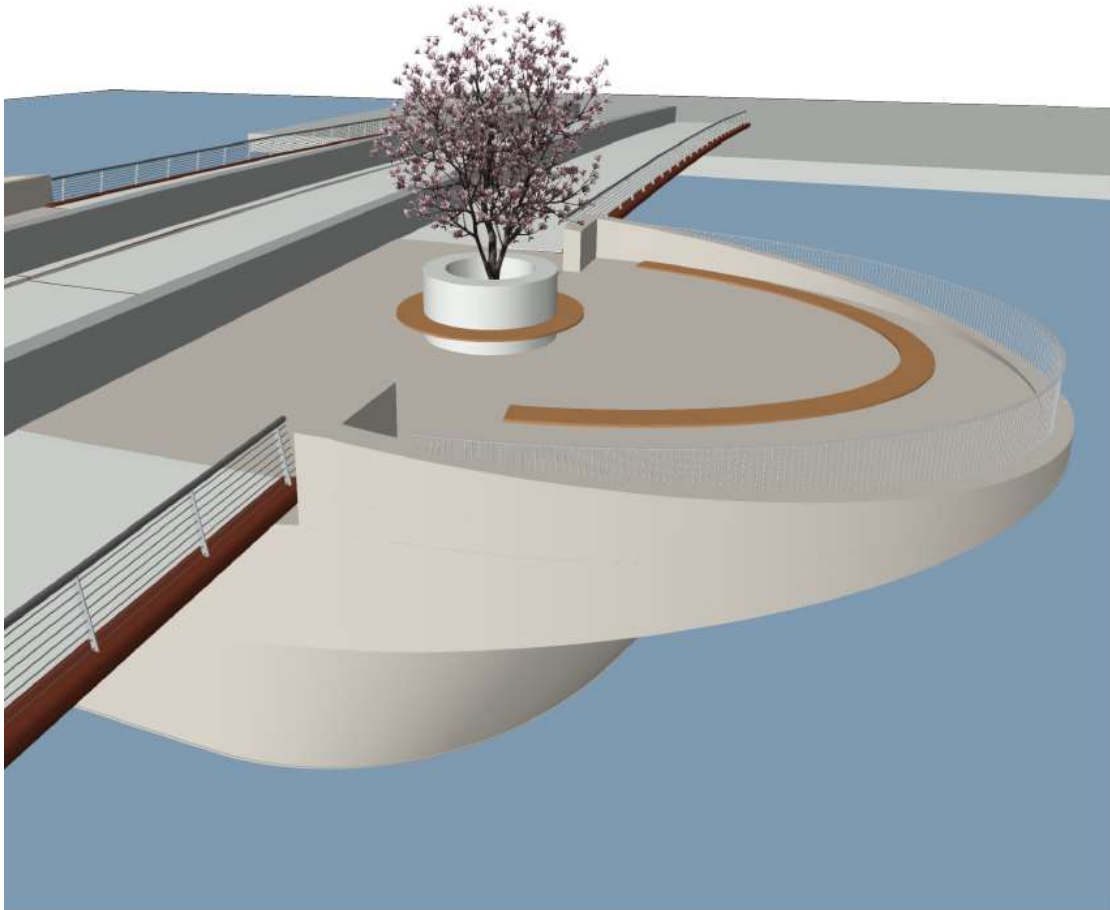

Figure 3.4 Bascule Pier public realm with seating, planting, and views

Details of the bridge arrangements is included in Appendix 2.

The Dublin City Council / St Patrick's Rowing Club building has notable aesthetic considerations – refer to Appendix 2 and Appendix 4.



Figure 3.5 Dublin City Council / St. Patrick's Rowing Club building

3.3 Proposals for the Recommended Structure

3.3.1 Proposed Category

Categories and structural reliability classes have been selected in accordance with IS EN 1990, DN-STR-03001 and GE-POL-01008 Table A.2. They are presented in Table 3.1.

Table 3.1 Categories and structural reliability classes

Item	Whole structure (check) Category	Consequence Class	Reliability Class	Design supervision level	Inspection level during execution
Dodder Bridge	3	CC3	RC3	DSL3	IL2
Reclaimed land and Point Bridge South Abutment	2	CC2	RC2	DSL2	IL2
Approach Retaining Walls	1	CC2	RC2	DSL2	IL2
Slipway	1	CC2	RC2	DSL2	IL2
Public Realm	n/a	n/a	n/a	n/a	n/a
St Patrick's Rowing Club / Dublin City Council Building	Refer to Appendix 4				

3.3.2 Span Arrangements

The bridge span arrangement is a three-span structure over the River Dodder, the west bascule span between west abutment and the bascule pier is 33.0m. The fixed centre span and east span are 25.15m and 26.4m respectively. An 11.15m length of bridge made up of the bascule top slab is between the western and central span. The heel back span shall be approximately 9.5m measured from the trunnion to the end of the counterweight. The structure provides articulations at the west bascule piers via a trunnion system. Full details of the MEICA technical provisions is including in Appendix 5.

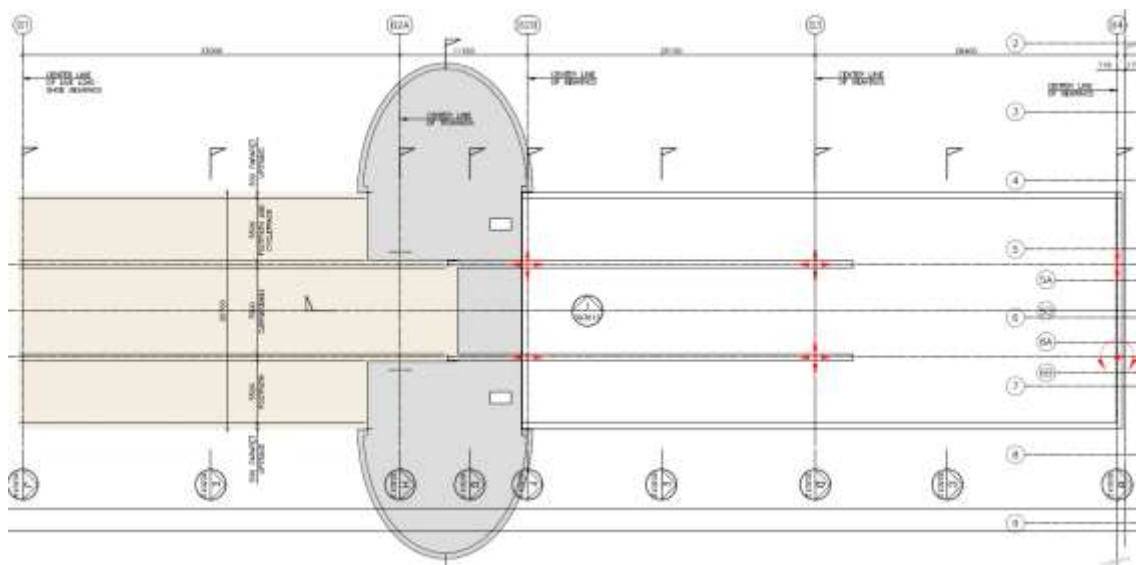

Figure 3.6 Proposed Dodder Bridge Plan Showing Spans

The leaf of the bridge will be connected in the lowered position by mechanised nose locks at the west abutment. These locks are designed to align the deck surfaces across the joint and assure the bridge cannot be inadvertently opened until the locks are withdrawn. The nose locks are disengaged for bridge raising by the linear actuators. Full details of the MEICA technical provisions is including in Appendix 5.

At the bascule pier, the transverse deck joints of both footways have been located in-line with the west wall of the bascule pier and longitudinal joint in line with the upstand face. The transverse roadway heel joint has been located approximate 4.2m rear of the centreline of trunnion. Due to this arrangement the rear of the bascule span will see no live load from pedestrian traffic and will only see minor live load action from roadway traffic; therefore, live load deflection concerns regarding the heel of the span due to live load will be negligible and tail locks shall not be included in the Design. Spanning over the counterweight will be a fixed deck slab of the bascule pier top slab. This pier top slab deck will transfer roadway live load, over the movable counterweight, onto the integral bascule pier walls and subsequently to the foundations below.

Longitudinal and transverse deck joints over the bascule pier structure and west abutment comprise elastomeric J-seals to mitigate water infiltration.

The bascule bridge piers shall be orthogonal to the new mainline roadway. General arrangement drawings are included in Appendix 2.

3.3.3 Minimum Headroom

The proposed bridge and approach roadways, footpaths, and cycle tracks will tie into existing public network to the west and east of the proposed scheme. Due to the limitations on the geometry of the Luas rails and the navigational requirements in the river, the vertical alignment of the bridge deck requires a gradual build-up of levels no greater than 5% gradient.

The bridge will provide the minimum requirements for both the raised and lowered positions namely: -

- When the bridge is lowered, a 2.7m high vertical clearance over the River Dodder (above MHWS level) over the navigational channel.
- When the bridge is raised fully to 70° rotation, it provides unlimited vertical clearance for a 19.0m wide navigational channel.

3.3.4 Approaches Including Run-on Arrangements

To the east, the road climbs up to the bridge on a formation retained by back-to-back retaining walls (see section 3.1). An approximately 19 m long approach ramp runs onto Sir John Rogerson's Quay to the west made up of retaining walls and wingwalls.

The reclaimed land slab has bored cast-in-place pile foundation supports at 6 m nominal centres.

3.3.5 Foundation Type

All foundations except the west bridge approach retaining walls are made up of in-situ reinforced concrete piles. Piles to the bridge are bored, 800 mm diameter and socketed into bed rock.

Piles for the reclaimed land are bored, 800 mm diameter and cast-in place concrete piles. The reclaimed land edges are retained by embedded sheet pile retaining walls. The sheet pile toes are anticipated to be driven to bed rock level.

All foundations and sheet pile toes are deep foundations. Scour risk shall be assessed fully at detailed design stage, though it is not envisaged that scour protection by riprap or otherwise shall be required.

The west approach retaining walls are pad foundations. The walls bear onto 6N/6P placed on top of fill to Sir John Rogerson's Quay. This may require local ground improvement to provide a suitable bearing layer and / or ensure that no adverse loading to the existing quay wall occurs.

3.3.6 Substructure

Dodder Bridge

The intent of the west abutment is to limit the length of the bascule span whilst minimising the permanent impact on the Britain Quay wall. This is achieved by installing piles with 0.5 m clearance to the envisaged buried back of wall. The back of wall arrangement has been confirmed by trial pits and probing. The abutment then cantilevers from the pile cap, out over the top of the quay wall with approximate 100mm clearance. The west abutment is reinforced concrete. It is arranged with a substantial mass provided over the piles and voided area towards the cantilever to ensure that the supporting piles are kept in compression.

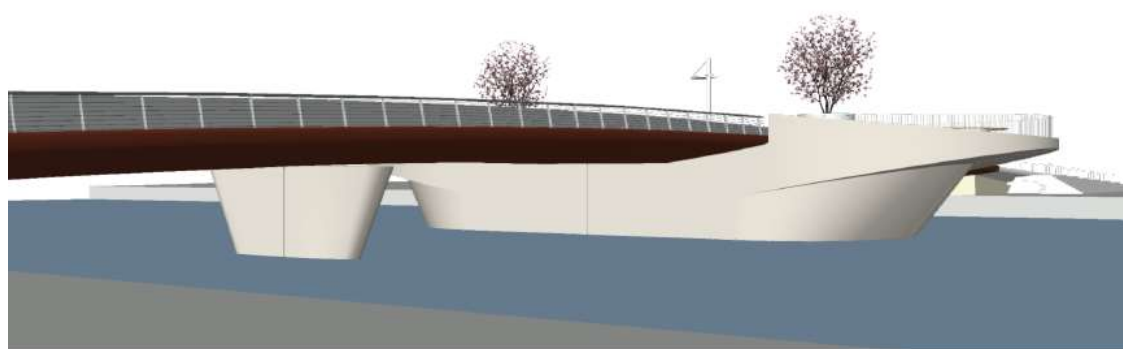

Figure 3.7 Dodder Bridge East and West Bascule Substructure

The west bascule pier will provide a chamber, with a foundation slab soffit at approximate level -5.4 mOD to accommodate an approximately 9.5m long counterweight heel span section. The base slab also forms the pile cap. The piers shall be supported by reinforced concrete bored pile foundations.

The west bascule pier also houses the machinery and associated electrical power and control systems required to raise and lower the bridge and it shall have appropriate access for inspection and maintenance. Reinforced concrete wall outstands shall be provided to support the trunnion bearings, hydraulic cylinders, and bascule pier top slab. Reinforced concrete platforms shall be provided to support operational equipment and allow adequate means of access for inspection and maintenance.

The hydraulic cylinders, hydraulic power units (HPUs), and associated hose and equipment will be located within the bascule pit chamber. The bascule piers will accommodate the hydraulic cylinder system clevis attachment connection to the substructure. Additionally, the trunnion bearings shall be supported by reinforced concrete trunnion wall local outstands to the base slab.

Full details of MEICA technical details are included Appendix 5.

The pier between the central and east span is made up of a profiled solid reinforced concrete pier supported by piled foundations. The east pier provides an articulated bearing support with the continuous superstructure. The provision for bearing articulation will be investigated further at the detailed design stage.

The east abutment houses the east span's east bearings on a shelf with a masking wall behind to retain the fill of the approach slope. A bearing inspection gallery is provided. The abutment abuts the back-to-back retaining walls which form the east approach.

Point Bridge south abutment foundation

The Point Bridge south abutment foundation is a reinforced concrete pile cap and piles integral with the reclaimed land pile supported slab. The pile cap is approximately 7 m wide to accommodate the proposed 6 m wide bridge deck. Full details of the Point Bridge south abutment general arrangements shall be developed as the bridge design progresses as part of a separate scheme.

The south abutment pile cap's top surface is proposed at the same level as the reclaimed land slab. The south abutment to the proposed Point Bridge is to be constructed at the same time as the reclaimed land pile supported slab. However, there is no available developed design for the Point Bridge. In the absence of a design, the south abutment foundation will be designed to take anticipated vertical, transverse, and longitudinal loads at the top of pile cap. This south abutment is assumed to support the Point Bridge superstructure on articulated bearings. Vertical starter bars to take the future abutment wall will be installed, protruding from the pile cap's top surface.

Substructure general waterproofing detailing

Waterproofing to all concrete substructures shall comply with Specification of Road Works document CC-SPW-02000. A certified spray applied bridge deck waterproofing is provided at the following locations:

- Internal surface of inspection galleries (i.e. at the back of the bascule pier and east abutment).
- Top surface of the bascule bridge pier top slab.
- Spray applied waterproofing systems, once installed correctly, have low maintenance requirements.

Buried surfaces shall receive two coats of bitumen paint in accordance with the Specification for Specification of Road Works document CC-SPW-02000.

3.3.7 Superstructure

The superstructure typology is of a steel orthotropic bridge deck which consists of a steel plate for the top flange which is stiffened and supported by steel trapezoidal and inverted T stiffeners. It is a wholly enclosed steel box with an orthotropic deck plate. This arrangement provides excellent resistance to torsional deformation and provides a smooth soffit with no external stiffeners or ribs visible. It is symmetrical about the carriageway centreline. The superstructure orthotropic top deck shall be combined with a bonded 16mm combined surfacing and waterproofing system, which shall carry the traffic loads. A deck cantilever is provided on each side, also consisting of a steel orthotropic deck, to accommodate the footpaths and cycle track over the bridge.

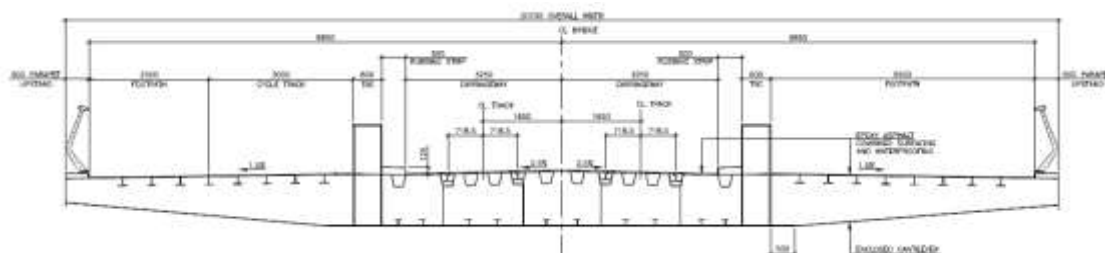

Figure 3.8 Dodder Bridge Deck Superstructure

The box is trapezoidal with slender width (20.7 m wide) to depth profile (approximately 1.2 m deep at the carriageway centreline). Vertical web box girders provide simplified welded connections within the box, plate profiling, the connections with the transverse beams and the structural connection at the trunnion system. The box soffit is flat underneath the carriageway, then slopes upwards underneath the cycle track and footway such that the box is approximately 0.5 m deep under the outer extents of the footway parapet. The deck plate falls transversely at 2.5% from the carriageway centreline down towards its kerb line; the cycle track and footway deck plates fall transversely at 1.5% towards the curb edge beam line. The box has regular transverse plate diaphragms. The box is separated longitudinally by four main internal webs, each pair of webs 0.6 m spacing to form two internal upstand boxes. These internal upstand boxes align with bearing positions and are positioned beneath the verge between the carriageway and footpath / cycle tracks. Over the bridge, the internal upstand boxes project up above carriageway level. The projection height is 1.0 m above the top of kerb. Four further internal webs are provided as rail bearers, approximately located under the future position of light rail (Luas) rails. The deck and soffit plates have longitudinal stiffeners which are continuous through the diaphragms.

Hydraulic cylinders are positioned forward of the trunnion axis, with cylinder pushing (extending) to raise the bridge. For this cylinder configuration two cylinders are provided in the design. For further details of the span operating hydraulic cylinders refer to Appendix 5.

As the bridge deck comprises of structural steelwork, it will require additional maintenance and painting when compared to a concrete structure. However, given the structural arrangement of the bridge, the reduction of dead load is paramount to achieving an economical structure such as the proposed design for Dodder Bridge. The weight of the forward span deck needs to be balanced against the heel span and a counterweight hidden within the bascule chamber to achieve an optimised centre of gravity of the bascule structure in proximity to the rotational point of the bascule shall be provided. For this reason, the heel span will have an extension of the rear superstructure approximately 9.5m beyond the trunnion in the longitudinal direction which will be a steel orthotropic box partially filled with concrete (or other ballast as required in the detailed design) and located within the bascule pier chamber. The final length of heel design will be optimised in relation to the interaction of the superstructure (forward span and heel/counterbalance) and the depth and size of the bascule chambers.

It is proposed to have the Dublin City Council Dodder Bridge Control Building as a self-contained unit as part of the new St. Patrick's Rowing Club Building. For further details refer to Appendix 4 and Appendix 5. The control building houses the electrical and bridge controls equipment in an environmentally controlled room and shall be provided with suitable welfare facilities. The control building is designed to maximise the sightlines to waterway traffic as well as to bridge users. The sightlines available from the control building will be supplemented with Closed Circuit Television cameras.

The bridge shall have a heel movement joint at the end of the bascule pier deck, as required to allow the opening of the bascule span. Between the tip of the forward span and west abutment a closing movement joint shall be provided.

As the superstructure consists of articulations at various locations along the deck and with the expected machinery present in movable bridges, the bearings, joints and other elements of the movable span will require regular maintenance and replacement.

For the steel orthotropic deck, a 16mm pavement thickness as carriageway deck surfacing is proposed. Bimagrip LS or equivalent combined surfacing and waterproofing is provided between the kerbs on the bridge. This material is suitable for very heavy traffic conditions. Bimagrip HD or equivalent combined surfacing and waterproofing is provided at the footpaths/cycle track. The Bimagrip and equivalent systems are designed to have long life durability and have performed well on other bascule bridges. The integrity of the system is important for the fatigue life of the orthotropic deck.

3.3.8 Articulation Arrangements, Joints, and Bearings

Bearings

The bascule leaf is supported on mechanical trunnion bearings that allow a vertical pivot movement about a horizontal axis. During movement and whilst the bridge is in the "raised" position, each leaf of the bridge is supported by the trunnion bearings and actuators (hydraulic cylinders). When the bridge is in its "lowered" position, a pair of live load bearings, located at the west abutment are provided to resist variable load located underneath the upstand box girders. Live Load Bearings include a cylindrical load shoe to accommodate local deflections. For further details on the trunnion, hydraulic cylinders and live load bearings refer to Appendix 5.

At the tip of the west bascule span, two nose lock bars linearly actuated will be housed within the west abutment. When the bridge is in the lowered position, these nose lock bars will be driven into receiving sockets of the bascule girders. These lock bars will provide shear variable load transfer and prevent differential movement/vibration under load. For further details on the nose locks refer to Appendix 5.

When the bridge is in the raised position, manually engaged mechanical restraints mountable to the counterweight assembly and lower bascule pier will be provided to hold the bridge in the raised position for inspection and maintenance operations. These holding devices will be manually adjustable and will be designed to resist dead and wind loading of the bascule span. These restraints will permit unloaded testing and servicing of the bridge's hydraulic operating machinery. For further details on the holding down restraints refer to Appendix 5.

The eastern and central spans are continuous and are supported by articulated bearings at the west bascule pier, east pier, and east abutment. The east abutment bearings will provide longitudinal restraint. In the detailed design stage, the east pier bearing provision will be further investigated to determine the possibility of eliminating the bearing support at the east pier and forming an integral moment connection between the concrete pier and the steel box superstructure.

For the fixed bridge span, EN 1337 bridge bearings are used. The bearing type will be selected to satisfy the designer's bearing schedule: most likely pot or spherical bearings with longitudinal fixity at the stiff east abutment will be required. These mechanical bearings shall be steel with protection of steelwork against corrosion in accordance with CC-SPW-01900 - Specification for Road Works Series 1900.

An inspection gallery to the back of the eastern abutment and west bascule pier will house the bearings for the longitudinal box beams. A designated area at the top of the east pier will be provided for bearing replacement using flat jacks.

Movement Joints

Given the bascule's closing nature, the interface joint between the substructure and superstructure shall be required at the west abutment and west bascule pier as described in Section 3.3.1 and 3.3.6. The joints for movable bridges need specific detailing and must be to a high standard to ensure an efficient drainage/structural solution which minimises the maintenance costs of the structure. Such joints are not necessarily covered by the DMRB and therefore, best international practice as outlined in Appendix 5 will be employed.

The inspection gallery to the back of the west bascule pier and east abutment, for the interface with the fixed superstructure deck, shall require a movement joint. In accordance with DN-STR-03006 'Expansion Joints for Use in Highway Bridge Decks', elastomeric in metal runners expansion joints shall be provided and shall extend across the full width of the carriageway and verges.

Should light rail (Luas) rails be installed in the future, these will require specialist expansion joints to suit the opening span above the west abutment and bascule pier. A rail expansion joint (breather switch) may be required over the east abutment.

For bridges, where the bearings and expansion joints are required, these joints often tend to be durability weak spots. Careful consideration must be given to the detailing of these elements, especially for a structure of this nature, during the detailed design stage to ensure that these elements reach their anticipated lifespan and do not cause the lifetime costs of the structure to become excessive.

3.3.9 Vehicle Restraint System (Bridge, East and West Approach Retaining Walls, Reclaimed Land)

Where vehicle parapets are provided the minimum parapet containment level is N1 unless noted otherwise. The bridge will not have a DN-STR-03011 (NRA BD 52/13) compliant vehicle parapet system over its entire length. Over bridge span, the road is segregated from the footpath / cycle tracks by the upstand boxes which are designed as bespoke restraint parapets. Note that given the potential for disproportionate collapse, these bespoke parapets are designed to resist loads equivalent to N2. The upstand box girder on the superstructure transitions to a 1.0 m high concrete or steel parapet on the approaches. These transitions are not compliant with DN-REQ-03034. Refer to the departure from standards in Section 6.3.2 6.3.2, 6.3.3 and proposed methods of dealing with aspects outside the standards in Section 6.4 for proposals in this regard.

Traffic control will be required in advance of opening the bridge. This will be in the form of "wigwag" signals, control barriers and sounders. Refer to MEICA technical details located in Appendix 5 of this document. Separate control barriers shall be provided across the carriageway and across the footpath/cycle track, preventing access to the moving section of the bridge for vehicles and pedestrians / cyclists in anticipation of a bridge opening/closing movement. The provision of separate barriers will allow the footways/cycle track to be closed earlier than the carriageway and placed closer to the bridge, reducing the road closure duration cycle for vehicular traffic and mitigating the impact on traffic in the vicinity.

Bollards on the cycle track and footpaths at the ends of the bridge prevent the entry of vehicles on to the cycle track and footpaths.

A bespoke pedestrian parapet 1.4 m tall is provided to both the north and south edge upstands and approach retaining walls where there is a vertical drop in excess of 1.0m. This parapet is of similar arrangement and detailing to the Rosie Hackett Bridge footpath parapet.

The edges of the reclaimed land on top of the sheet pile wall does not have a vehicle restraint system in keeping with the arrangement at other areas of the quays. However, a light pedestrian parapet / handrail or otherwise will be installed.

3.3.10 Drainage

As far as is practicable, all surface water shall be intercepted and conveyed to a drainage network i.e. no direct discharge into the watercourses.

For the bascule span, it is proposed to collect the surface water along a continuous kerb which will convey over the west abutment movement joint and outfall to gullies adjacent to the bridge and tie in with the mainline road drainage system. Deck and carriageway falls are provided to ensure that no ponding on or beneath the deck surfacing occurs, the bridge is located on a crest curve with the crest adjacent to the mid span of the bridge. The southern and northern verges have a transverse fall towards the edges of 1.5%. The carriageway has a 2.5% fall from the centreline of road to the north to south kerbs. Under the west abutment movement joint a drainage channel will be provided for any water collection under the movement joint, where it will be discharged to the road drainage system. To the west, drainage connects to tie ins into the existing Sir John Rogerson's Quay drainage network.

Bridge deck drainage on the central and east span and on the bridge approaches is collected either by continuous kerb drains or a similar surface collection system to that provided on the bascule bridge. The bridge deck has crossfalls (see section 3.3.7), conveying water to kerbs and a significant longitudinal fall. The water will ultimately be conveyed past the east abutment and joins the reclaimed land road drainage network. To the east, drainage outfalls into the existing road drainage network.

The bascule pier chamber will be detailed with a sump pit. A pump will be utilised to drain the sump and discharge to the drainage system on the fixed bridge and onwards towards the reclaimed land drainage network.

The reclaimed land includes subsurface drainage on the top of the slab.

In order to protect properties on Thorncastle Street from flooding, it is proposed to include a flood defence wall/gate in the landscaped area adjacent to Thorncastle Street, as part of the proposed development.

Rodding eyes are provided at regular centres along all drainage pipes and at all bends.

3.3.11 Durability

Design detailing for durability to reduce the need for maintenance activities is at the forefront of design decisions. For details of materials and finishes refer to Section 3.3.14 for further details.

Foundations & Substructure

The proposed foundations & substructure are in a marine and land environment and hence due allowance for corrosion protection shall be required. The steel permanent casing to the piles will be designed considering corrosion rates. The substructure is comprised of reinforced concrete elements that will contain ground granulated blast furnace slag (GGBS) cement replacement content. The design and detailing of concrete shall meet the durability requirements of the relevant standards. CEM III/A concrete is proposed for most structural concrete as XS3 exposure class conditions are prevalent on site. Cover exceeding the minimum requirements is proposed for various elements.

Superstructure

All external concrete surfaces will be visible for inspection. Durability of the steel structures will be considered by careful detailing to prevent corrosion using the guidance provided in EN ISO 12944, Part 3 where relevant.

Parapets / Other Finishes

The proposed parapets are a significant feature of the bridge and, therefore, an architectural parapet design is proposed. For details of parapets materials and finishes refer to Section 3.3.14 for further details. The layout of seating, planting and litter bins are detailed in the architectural drawings and details will be agreed with Dublin City Council.

3.3.12 Sustainability

Sustainable development has been considered for the preliminary design of the Dodder Public Transport Opening Bridge Project to enable a cost-effective and sustainable solution which has a minimal impact on the surrounding environment.

The overall premise of the project is one of notable sustainability: to promote the use of public transport, cycling and walking between two areas of the city which currently have limited connectivity. At a more detailed level, a simple efficient design, minimising the use of materials and standard methods of construction and new imported materials are typically being used. However, there may be opportunity to reuse materials recovered from site or from neighbouring construction sites:

- Excavation requirements are kept to a minimum by adoption a piled slab and piled foundation solution, where the depth of excavation to reach good ground is excessive.
- Reuse of riprap around the existing St Patrick's Rowing Club boat house for the reclaimed land perimeter and / or bridge pile caps.
- Subject to the particular requirements of the Waste Management Guidelines, it may be possible for the fill material for the reclaimed land to be taken from other construction sites in the city.

In relation to the new St Patricks Rowin Club boat house the use of sustainable and renewable energy systems will be assessed for their suitability for use in the building, including:-

- Heat pumps – air to water
- Solar photovoltaic (PV) energy solutions
- Mechanical heat recovery ventilation (MHRV);
- Variable speed demand controlled pumps and fans
- High efficiency LED lighting
- Metering of mechanical and electrical systems for measuring and recording

3.3.13 Inspection and Maintenance

All structures require regular inspections and routine maintenance and replacement of certain components during their design life. These are the structural concrete, structure steelwork, bridge bearings, movement joints, waterproofing, pedestrian parapets, lighting and lifting span mechanisms. The expected maintenance requirements are described below for each bridge element. The structure will be subject to a programme of principal inspections along the guidelines of AM-STR-06054.

For the design of the steel orthotropic deck, the recommendations of the TII Publication DN-STR-03012 'Design for Durability'. Clause 2.7 recommends that the size of box sections in bridge decks should be such that proper inspection and maintenance within the box can be carried out otherwise the box shall be sealed to prevent water or airborne pollutants from entering the interior of the box. The proposed depth of the deck for the bascule bridge at the centreline of the carriageway is approximately 1.2m. Access would be difficult due to being a confined space with limited height clearance. Therefore, it is proposed to treat the superstructure box of the bascule and fixed bridge as a sealed box with no access. At the detailed design stage, the longitudinal upstand portions (with the localised extended height provision) of the superstructure box may be considered for access use.

Deck steelwork corrosion protection inspection and maintenance will be required. Inspection can be completed from a boat while in the lowered position or using a drone while the bridge is in either the raised or lowered position. Following detailed engagement with the Client's bridge maintenance department, an Operations and Maintenance Manual methodology for maintenance of the deck corrosion protection system shall be developed. The methodology will mitigate risk of harm for maintainers, the public, river users and the environment as required.

The external panels are planar in shape which will simplify future maintenance. The internal surfaces of the box girders are provided with a reduced corrosion protection system and will be sealed from moisture and debris.

Design and detailing for ease of access for inspection and maintenance operations will be addressed for all aspects. For the bascule bridge superstructure, it is proposed no access will be provided at this stage of the design. Inspection and maintenance of the bascule piers will be relatively straightforward due to their accessibility from the bridge bascule top slab deck hatches. The substructure piers and abutments, and the reclaimed land pile supported slab comprises largely reinforced concrete which should not incur any substantial maintenance costs and will be designed to achieve the required 120-year design life. Access to the bascule chamber for close inspection may be gained with the assistance of the internal walkways and platforms. The structure can be accessed on foot, using binoculars to get a better view of details where required. All external surfaces of the bridge superstructure can be inspected and maintained from the bridge deck and the river beneath.

Examples of the access provisions that will be considered include:

- Access into the main crossing deck through the bascule piers via access stairs and platforms for deck level access hatch.
- Inspection galleries for ease of access to bearings, and expansion joints.
- Stairways/ladders provided within bridge bascule pier.

Access manholes with locked, hinged covers are provided in each footpath/cycle track above the bascule pier to allow access down into the bascule pier and counterweight pit.

The nose locks are located in the west abutment. This avoids the need for access to the tip of the deck superstructure for inspection/maintenance. The nose locks can be accessed by locked hatches at the west abutment accessible from the footpath / cycle tracks via manholes.

Live load bearings at the toe of the bascule span will require the bridge to be in the open position for bearing maintenance or replacement. Trunnion bearing replacement, if required, would be major works requiring temporary propping of the bascule span. For further inspection and maintenance requirements for the MEICA components refer to Appendix 5.

An inspection gallery will be provided in accordance with the recommendations of DN-STR-03012, and CIRIA C543 which will allow access to the fixed bridge bearings and joints. An access will be provided to the fixed bridge west bascule gallery from the bascule pier chamber. At all fixed bridge bearing locations jacking points shall be detailed and provided to lift the deck during bearing replacement.

Access will be provided throughout the full extent of the interior of the bascule pier by means of stairs, platforms, and ladders. Permanent platforms will be installed at the following locations where regular access is required;

- Electrical equipment
- Trunnion assembly
- HPU units
- Hydraulic cylinders, including upper clevises

The interior lighting system will consist of luminaires installed throughout inspection galleries, and bascule piers. All access areas, walkways and platforms within the bascule pier, mechanical and electrical plant areas will be provided with interior lighting. All luminaires will be suitable for the environment in which they will be installed.

Maintenance vehicle access onto the footway and cycle track is limited to a service vehicle (see section 6.1.9.3). The carriageway can be open to normal traffic / light rail (Luas) loading, but not special vehicles.

3.3.14 Materials and Finishes

Reinforced Concrete

Exposed concrete elements shall have a high-quality texture finish. Otherwise, all concrete elements including the bridge substructure are F1 finish.

C40/50 concrete is proposed for the bridge substructure elements and approach retaining walls. CEM III/A concrete is proposed for most structural concrete as XS3 exposure class conditions are prevalent on site. This contains a high proportion of ground granulated blast furnace slag (GGBS), a by-product of the steel industry. The pile cap / pier concrete includes 50% GGBS cement replacement which increases durability in a marine environment. The reclaimed land's slab and slipway is C32/40, also of 50% GGBS cement replacement. Durability requirements are shown in Table 3.2 for the various concrete elements. The design and detailing of concrete meet the durability requirements of the relevant standards

All reinforcement is carbon steel high yield grade B500B or B500C and comply with I.S. EN 10080 and BS 4449:2005 (Grade B500B or C).

Table 3.2 Concrete durability requirements

Element	Governing Exposure Class	Cover, c_{nom}	Concrete Strength Class
Pile caps	XS2	65	C40/50
Bridge Bascule Pier – General	XS3	65	C40/50
Bridge Bascule Pier – Deck Level Top Surface	XC3/4, XD1	45	C40/50
Bridge Bascule Counterweight	XC3/4, XD1	NA	C40/50
Piers	XS3	65	C40/50
Abutments	XS1	65	C40/50
Reclaimed land slab	XS2	65	C32/40
Slipway	XS3	65	C32/40

Exposed concrete is surface impregnated with a hydrophobic pore liner.

It is proposed to provide the following c_{nom} in order to rationalise the result of Table 3.3;

- 75mm to piled foundations.
- 65mm to bascule pier outer wall surfaces, deck level parapet edge beams, pile supported slabs, abutments, piers.
- 45mm to bascule pier inner wall surfaces, interior elements within chamber.
- 45mm to top of bascule pier deck slab.

Structural Steelwork

All structural steelwork is typically grade S355, fabricated to the TII Specification for Road Works series 1800 and IS EN 1090. The bridge superstructure is generally of IS EN 1090 welded steel plates to IS EN 10025-2. Secondary steelwork used for access inside the bascule pier is of hot or cold rolled steel sections.

Any bolts used in the bridge superstructure or otherwise subject to bridge loading are preloaded, series HR or HRC to IS EN 14399.

Protective systems to structural steelwork

Corrosion protection systems are provided for all structural steelwork components to reflect the exposure and difficulty of access for inspection and repainting. The corrosion protection systems specified reflect best international bridge construction practice.

The structural steelwork shall be provided with a painted corrosion protection system. Modern painting systems have a life of up to 25 years before the first major maintenance painting.

All paintwork is compliant with TII Specification for Roadworks series 1900, options summarised in Table 3.3. As far as is reasonably practicable, all paintwork is shop applied with structural steelwork delivered to site with the full system already applied.

Secondary steelwork, handrails, walkway grillages etc inside the bascule pier and any other access steelwork and handrails forming accesses to bearings shelves at the abutments are hot dip galvanised to a marine standard (85µm minimum coating thickness) which will meet or exceed the required life to maintenance/replacement.

Table 3.3 Structural steelwork paint

Element	Type	Topcoat colour	Notes
External surfaces – bridge superstructure, soffit	II	To be specified at detail design stage	
External surfaces – bridge superstructure, upstand girders	II	To be specified at detail design stage	To include a graffiti removal agent.
Internal surfaces – bridge superstructure (box)	III	White, very light grey or light yellow.	
Bridge bearings	V	TBC – same as external surfaces	

Parapets

Vehicular parapets shall be steel which will be corrosion protection painted similar to the superstructure external surfaces. Pedestrian parapets on the deck edges shall be stainless steel.

Sheet Piles

Permanent sheet piles are grade S275 or S355. Piles will be of Larssen type (pan depth 480 mm), size to be confirmed at the detailed design stage. Visible areas of sheet piles are to be clad with stone of similar appearance to the Liffey quay walls.

Backfill

Structural backfill to the bridge abutments shall be 6N/6P. Backfill to the reclaimed land is 6N/6P under the building and road. Provisionally, 6N/6P shall be used elsewhere as general fill on top of the reclaimed land. However, opportunity may be identified at the detailed design stage or even during construction to use locally won material.

3.4 Light Rail Requirement

Recesses are provided within the deck to accommodate future installation of two tram tracks, 3.30 m between centres of the tracks symmetrical about the bridge centreline, 1435 mm gauge Ri59N grooved rail and its fixings. The recess is covered by a removable plate which is to be sealed in place by a removable compound. Carriageway surfacing is placed over the cover plates in a continuous, seamless manner.

The provisional requirements for electrical supply and communications to the Luas light rail system shall be confirmed with Transport Infrastructure Ireland.

Moveable bridges typically provide for OLE by use of a conductor bar arrangement with a gap between the moveable and fixed spans. Accommodating such an arrangement on a bascule bridge is complicated by the manner in which the bascule's back span rotates and moves below the adjacent fixed span into the bascule pit. Future options for OLE could include:

- Use of OLE equipment which cantilevers out from the backspan, but then lifts with the bridge in a similar arrangement to a crane with a lifting jib (as on the Erasmus Bridge, Rotterdam).
- Ground-level power supply – a buried third and fourth rail in a conduit between rails as used in Bordeaux and the Dubai tram. This would require a different form of rolling stock than that currently used with a retractable pantograph and ground electrical supply pick-up. This is deemed unlikely to be adopted in Dublin and is not carried forward as a future-proofed option.
- No OLE over the bridge: trams with retractable pantographs, and batteries or other forms of onboard energy storage to travel over the bridge.

The bascule and fixed span bridge deck superstructure steelwork shall be electrically continuous with connectors installed at each end of the bridge to allow for installation of earthing and bonding as part of a stray current protection arrangement.

3.5 M&E Installation in Moveable Structures

For the technical details of the proposed MEICA installation for the bascule bridge refer to the report in Section 5.

3.6 Slipway Requirements

The slipway meets the requirements of the UK's Inland Waterways Association Standard Slipway drawing, revision Nov 2012.

3.7 ESB Sub-station

A 3-phase, 275 kVA, 400V power supply is required for the control cabinets and plant room, situated within the bascule pier. The utility power supply value is based on the calculated lift cylinder loading and plant/control room power requirements. The existing sub-station on York Road does not have sufficient capacity to supply power to the new bridge and the ESB confirmed that anything above a 200kVA load would require its own substation.

A new sub-station building will be constructed adjacent to the site of the existing St Patricks Rowing Club Building with access provided via York Road. The building will be 4.88m by 4.43m and incorporate a separate DCC switch room as part of the substation building. Details and specifications for the new sub-station will generally be in accordance with the published standard details contained within the ESB Code of Practice document.

The power required to operate the locking pins on the Sir John Rogersons Quay side of the Dodder is likely to be less than 20kVA. Therefore, a standard service pillar (about 1.4m high and 0.5m deep) as indicated in the ESB Code of Practice document will be provided on this side of the bridge.

4. SAFETY

This section does not include the Dublin City Council / St Patrick's Rowing Club building – refer to Appendix 4 for details.

4.1 Traffic Management During Construction

Traffic impacts on the existing road network is minimal during the main bridge construction: the works are predominantly offline. Traffic management will be provided at the interface of the online and offline section to allow access and egress of construction traffic. The tie-in to the existing R131 approach to the Tom Clarke Bridge will take place with short lane closures only during periods of low traffic flow.

4.2 Safety During Construction

The Designer will comply with the General Principles of Prevention (of accidents) as specified in the First Schedule of the Safety, Health and Welfare at Work (General Application) Regulation and liaise with the Project Supervisor for the Design Stage (PSDP) appointed by the Client and the Project Supervisor appointed for the Construction Stage as required by the "*Safety, Health and Welfare at Work (Construction) Regulations, 2013*".

A viable construction sequence has been considered at the preliminary design stage. The requirement for temporary works i.e. cofferdam construction and working platform associated with the proposed construction sequence have been identified.

A staged construction sequence is envisaged to limit impact on third parties, adjacent roadway and waterway users. In summary the broad construction stages are:

- Stage 1 – Construct the reclaimed land including the pile supported slabs and Point Bridge south abutment, install cofferdams for Dodder Bridge piers and temporary earth support structures around the west abutment. Construct Dodder Bridge abutments.
- Stage 2 – Construct the east and west approach structures and Dublin City Council / St Patrick's Rowing Club building.
- Stage 3 – Install the bridge, demolish the existing St Patrick's Rowing Club building, road and finishing works, tie-in new eastern junction to R131.

Stage 3 shall require a detailed construction sequence due to its complexity. Due to the location of the bridge within a waterway area, the construction of the bridge must be carefully detailed and monitored to ensure that unnecessary impacts on the local ecosystem do not occur. Measures shall be specially taken to minimise the impact on the River Dodder and River Liffey.

Liaison and consultation with the relevant Authorities/Stakeholders will continue as part of the detailed design process and the requirements of these authorities will be incorporated into the design. A traffic management plan will be implemented prior to construction works. The site shall be set-up, site clearance shall commence and the installation of mitigation measures.

Waterway vessel movements on the River Liffey are always to be unimpeded. The requirements on acceptable navigation width, headroom, and temporary closure durations for the River Dodder during construction is to be agreed with Waterways Ireland.

Below is a summary of the main features of the anticipated construction of the bridge structure; details will be confirmed during the detail design process.

The temporary works cofferdam shall be installed. The cofferdam construction shall require internal walers / strutting and dewatering sequence as the excavation works precedes. The permanent works bridge foundation shall be constructed inside the cofferdam construction. The 2.0m bascule pier base slab will be constructed on a granular fill / concrete blinding layer.

The reinforced concrete wall and platform elements of the bascule piers shall be constructed.

For the substructure construction, following the construction of the concrete walls and internal platforms, the bearing and hydraulic cylinder plinths shall be constructed.

The steelwork superstructure shall be first fabricated and provided with corrosion protection off-site. The superstructure section(s) shall be river or road transported to site. The sections will be erected on-site during a channel possession as agreed with the relevant Authorities. The concrete counterweight infill will be poured. Subsequently the MEICA system will be commissioned and tested. Fine tuning and testing of the MEICA works will take place with counterweight fine adjustment completed. The combined waterproofing / deck surfacing shall be installed as well as all finishing works such as service ducts and barriers/parapets.

The finishes, including lighting (internal and external), wigwag control barriers, secondary access stairs steelwork and platforms shall be installed/constructed. The site will then be reinstated and landscaped as part of the accommodation works.

4.3 Safety in Use

The pedestrian footpath and cycleway are to be separated from the carriageway by a steel upstand restraint system.

A derailment protection channel is to be provided beside one of the Luas rails. All superstructure steelwork in the deck will be designed to incorporate the requirements for stray current.

The combined deck waterproofing surfacing is 16 mm thick and includes a resin bound aggregate system. The surfacing also acts as a waterproofing membrane, has high resistance to the marine environment and provides the required slip resistance for all bridge users. It has sufficient adhesion to transmit traction and braking loads, and to remain attached and not prone to creep to the bascule span whilst in the open position for prolonged periods.

4.3.1 Ship Impact Protection

The bridge bascule pier substructure shall be designed for vessel impact as appropriate to the vessel fleet characteristics and vessel speed at this location on the Dodder. The bascule pier walls will be designed with adequate structural capacity to withstand the design vessel impact force.

A design vessel impacting the bridge superstructure with its mast structure in a direction transverse to the span shall also be considered. The bridge bearings and their support structures shall be capable of transmitting the resulting loading to the substructure with no significant damage that would render them unable to continue to

support the superstructure. The bridge superstructure shall be designed for impact of a vessel mast.

4.3.2 Lifting Span in Operation

Refer to Appendix 5 for details of the safety measures for the lifting span in operation.

4.3.3 Changes in Bridge Use

The bridge is not intended to be used by normal use road traffic or special vehicles. However, it has been designed to resist these loads and it may be safe to open the bridge to normal traffic for occasional, short durations or occasional passage of a special vehicle. Should the bridge ever be opened to normal road traffic on a continuous basis, the suitability of the vehicle restraint system would require appraisal. The residual fatigue life should be appraised.

If the bridge were to cease its use as an opening bridge and the bascule span became fixed, care would be required to ensure that the bascule span's permanent actions continue to be supported at the bascule span only, and are not transferred to the west abutment as a result of jacking for bearing replacement, foundation settlement, resurfacing etc.

Amongst other items, the following will need consideration if the bridge is adapted in the future to carry light rail (Luas) with TII:

- Installation of rails, including expansion switches.
- Installation of OLE, including an arrangement that accommodates the opening span.
- Stray current protection.
- Adjustment to the counterweight to reflect changes in permanent action from the rail, OLE and other light rail (Luas) infrastructure on the bascule span.
- Modification to traffic signals on the approaches.
- Assessment of derailment risk and identification of mitigation measures, notably on the upstand girder and possibility of disproportionate collapse.

4.3.4 Bridge Deck & Approach Environment

The dimensional, safety and disabled access features of the bridge, its approach stairs / ramps and public realm areas comply with the requirements as defined in TII DN-STR-03005 (NRA BD 29).

4.3.5 Bridge Traffic – Road, Cycle and Pedestrian

Access to normal traffic over the bridge is prohibited in usual operation. This is indicated by signage and road markings in a similar manner to that at the Rosie Hackett Bridge.

Cycle and pedestrian zones are clearly marked with lineage. Locked, removable bollards are installed to prevent vehicular access onto the footways and cycle tracks under normal operation (see section 3.3.9). Vehicular access onto the footways and cycle tracks is only permitted for a single inspection / maintenance vehicle or emergency vehicle with the remainder of the footway / cycle track on the same side as the bridge closed.

4.3.6 Bridge Traffic – Light Rail

Provision has been made for a derailment protection channel to be provided beside one of the Luas rails.

4.4 Lighting

The interior access and emergency lighting system will consist of luminaires installed throughout the internal access area of the bascule pier, inspection galleries and control buildings. All access areas, walkways and platforms within the bascule pier and galleries, mechanical and electrical plant areas will be provided with interior lighting. The access lighting shall have a minimum intensity of 30lux. All luminaires will be suitable for the environment in which they will be installed.

Navigation lights shall be provided to control vessels in the navigational channel below the bridge.

The proposed structure will utilise architectural lighting to enhance the aesthetics of the structure at night-time. The lighting will be designed to provide sufficient illumination to the deck while acting as a visual gateway to the structure. Architectural lighting is also proposed for the seating and planting and along the footpaths/cycle tracks and in the pedestrian parapet handrail. For lighting in the public realm areas, off the bridge, it is proposed to install LED downlighters on stainless steel posts or similar. The bridge road lighting shall be provided by strip lighting along the upstand beam. The interaction of all architectural and road lighting with the bridge furniture will be carefully considered at the detailed design stage.

5. COST

5.1 Preliminary Cost Estimate

The base information for the construction cost estimate and whole life cost of the proposed scheme are included in Appendix 7.1. The construction cost estimate has been prepared based on a price Bill of Quantities.

The Preliminary Cost Estimate has been prepared in accordance with the “*Cost Management Guidelines for Projects funded by the National Transport Authority*”, September 2019 and a separate standalone Preliminary Cost Estimate Report has been prepared in accordance with the requirements of Appendix R (“*Band 3 & 4 Cost Estimate Report Template*”). This Preliminary Cost Estimate Report includes: -

- Preliminary Cost Estimate (Appendix I) including the details of the cost estimate, basis (assumptions and exclusions), expenditure profile and comparison with previous estimates;
- Quantitative Risk Assessment (Appendix Q);
- Contingency Calculator (Appendix C).

5.2 Cost Estimate Background

Refer to Preliminary Cost Estimate Report in item 5.1 for background, assumptions, and exclusions.

5.3 Basis of Cost Estimate

Refer to Preliminary Cost Estimate Report in item 5.1 for the basis of the cost estimate.

6. DESIGN ASSESSMENT CRITERIA

This section does not include the Dublin City Council / St Patrick's Rowing Club building – refer to Appendix 4 for details.

6.1 Actions

6.1.1 Permanent Actions

All relevant permanent actions as defined in IS EN 1991-1-1 and the National Annex. Variability of surfacing shall be considered in accordance with the National Annex of IS EN 1991-1.

Two arrangements of permanent actions are used: without light rail (Luas) and with light rail.

- Permanent load arrangement 1 – on opening, without light rail (Luas).
- Permanent load arrangement 2 – following future modification to accommodate light rail (Luas) including its tracks and electrification.

Note that these two permanent load arrangements result in differing demands on the bascule bridge's mechanical and electrical elements and / or require and adjustment to the counterweight. The bridge design accommodates both permanent load arrangements and allows for straightforward future adjustment to the counterweight.

Allowance is made when considering permanent actions for loads associated with scaffolding and encapsulation of the bascule span soffit in the closed position. These loads put additional permanent load demands on the bridge, notably on the west abutment bearings and substructure.

The following nominal densities are used:

- | | |
|----------------------------|--|
| • Reinforced concrete | 25kN/m ³ |
| • Structural steel | 77kN/m ³ |
| • Backfill to substructure | Upper bound 21.5kN/m ³
Lower bound 20.5kN/m ³ |
| • Surfacing | 22kN/m ³ |

6.1.2 Snow, Wind and Thermal Actions

Snow, wind and thermal actions as outlined in IS EN 1991-1-3, 1991-1-4, 1991-1-5 and the applicable Irish National Annexes.

Snow action shall not be considered due to the geographical location as outlined in IS EN 1990: 2002 + A1: 2005 except in consideration of the moveable equipment as described in Appendix C.

For the design of the structural elements of the superstructure, the wind actions shall be applied in accordance with IS EN 1991-1-4 and the National Annex.

The design wind speed associated with operation of the moveable span is not specifically addressed in the Eurocodes. The Eurocode use of this wind speed value to design the M&E of the moveable span is not necessarily recommended. See Appendix 5 for the wind actions in M&E Design.

It is envisaged that the operating conditions for trafficking on the bridge with light rail (Luas) is likely to be similar to that of a road rather than a railway, As such, ψ factors

for wind forces when combined with light rail (Luas) are to NA to IS EN 1990 Table NA.A2.1.

6.1.3 Actions Relating to Normal Traffic

Normal traffic actions are LM1 and LM2 from IS EN 1991-2 and the National Annex. Traffic surcharge loading is behind the bridge abutment are calculated in accordance with IS EN 1991-2:2003 and PD 6694-1:2011. The effects of the traffic models are applied in accordance with clause 7.6.2 and 7.6.3 of PD 6694-1:2011.

6.1.4 Actions Relating to Abnormal Traffic

The abnormal live load model LM3 to IS EN 1991-2 and its Irish National Annex will be applied and include SV196.

6.1.5 Footway Live Loading

Where used in combination with LM1, IS EN 1991-2 clause 5.3.2.1 incorporating the National Annex is used.

Load Model 4 to IS EN 1991-2 and UK National Annex to include UDL and concentrated load in accordance with IS EN 1991-2 Clause 5.3.2.1, Clause 5.3.2.2 and NA 2.36 (5kN/m² to be applied) and 2.37 respectively.

IS EN 1990 clause A2.4.3 verifications concerning vibration for footbridges due to pedestrian traffic is as per NA to IS EN 1990 i.e. NA to IS EN 1991-2 clause NA.2.46. The verification is made for pedestrians present on all parts of the cycle tracks and footways. A calculation is made to understand the response should pedestrian loading occur over the whole of the bridge deck i.e. on the carriageway as well. This calculation is used to inform recommendations for the operation of the bridge as to the levels of pedestrian discomfort that could occur should the whole of the bridge deck be opened for exceptional events.

6.1.6 Provision for Exceptional Abnormal Loads

None.

6.1.7 Accidental Actions

The superstructure and substructure shall be designed for vessel impact caused by the impact from vessels on the River Dodder based on the vessel fleet characteristics and vessel speeds at this bridge location. The ship impact load case for an impact on the structure shall be taken from the AASHTO Guidance Specification for Vessel Collision.

The bascule and central span's upstand girder are treated as a rigid parapet i.e. class B in Table NA.6 of NA to IS EN 1991-2. Elsewhere, values appropriate to the parapet type recommended by Table NA.6 are used.

Accidental vehicle loading on footways shall be considered in accordance with IS EN 1991-2 Cl. 4.7.3 and its Irish National Annex.

6.1.8 Actions During Construction

The design shall take account of any adverse loading during construction as outlined in clause 4.11 and 4.12 in IS EN 1991-1-6 and its Irish National Annex. Specifically, the design shall take account of required construction vehicles and the actions will be applied as described in section 4.1 above.

Flood levels and associated loadings for a combined high tide and flood level are to be detailed for the construction design scenarios.

6.1.9 Any Special Loading Not Covered Above

6.1.9.1 Light rail (Luas)

Light rail (Luas) loading is half the magnitude of RL ($\frac{1}{2}$ RL) loading of TII AM-STR-06030 (NRA BD 37/14) including the following changes / additions / clarifications:

- A dynamic factor of 1.50 is used, not the dynamic factors presented in clause 8.2.3.2.
- Clause 8.3's load combinations or partial factors presented elsewhere in BD 37 are not used.
- Deformation and vibration of the bridge under $\frac{1}{2}$ RL at SLS meets the requirements of IS EN 1990 clause A2.4.4. The recommended values of NA to IS EN 1990 are used with the following project requirements:
 - NA.2.3.11.6 for the limitations on the rotation of non-ballasted bridge deck ends with expansion devices are to be determined at detailed design and then discussed with the technical approval authority to determine their suitability to support Luas. The values to be discussed are: change of angle; uplift; bending moment of a rail joint within 25 m of the end of a bridge.
- For light rail loading, EN 1990 and the associated National Annex's partial factor γ_Q and ψ factors are as per LM71's values.

6.1.9.2 Bascule Bridge

For details of bascule bridge specific loading considerations refer to Appendix 5.

6.1.9.3 Footway / Cycle Track Service Vehicle

The use of an underbridge inspection vehicle or emergency vehicular access may be required on the footway / cycle track. Access is managed by Dublin City Council as bridge operator using the removable bollards. This is allowed for in design by use of NA to IS EN 1991-2 NA.2.40's service vehicle in a ULS STR combination.

Otherwise, given the presence of permanent provisions to prevent the entry of vehicles on to the cycle track and footways, the service vehicle is not considered.

6.1.9.4 Fatigue Load Model

Given the bridge's proposed carriageway use by buses and taxis only, with only very occasional use of heavy goods vehicles or special vehicles, fatigue from carriageway traffic loading is envisaged to be not critical. Nonetheless, vehicular fatigue loading shall be Fatigue Load Model 3 (FLM3) applied in accordance with IS EN 1991-2 and the associated Irish National Annex. For Fatigue Load Model 3 the requirements of clause 4.6.4 of IS EN 1991-2 as modified by NA.2.25 of the associated Irish national annex shall apply. The presence of two vehicles in the same lane should be considered in the design, where the effect is more severe when the distance between the two vehicles, measured from centre to centre of vehicles, is not less than 40 metres. Site specific parameters shall be used for in the fatigue load calculations for:

- *The number of observations, Nobs*, of heavy vehicles / lorries, observed or estimated, per year and per slow lane as per IS EN1991-2, 4.6.
- The average gross weight, Q_{m1} , of the heavy vehicles / lorries in the slow lane

High magnitude, low cycle loading patterns from bridge opening are to be assessed for fatigue risk.

Fatigue from light rail (tram) loading is to be designed for the RL model of BS 5400-10, assessed to BS 5400-10, not Eurocode (refer to departure from standards number 3, section 6.3.3). TII requirement for investigation for fatigue from tram loading frequency and proposed residual design life shall be determined through consultation with TII. Note the use of full RL, not ½RL here: BS 5400-10's RL fatigue model is for 10 tonne axles, similar to those of the current Luas rolling stock.

6.1.9.5 Actions on Pedestrian Parapets

Actions on pedestrian parapets are in accordance with NA to IS EN 1991-2. Cl. NA.2.34 & NA.2.35.

6.1.9.6 Load Model for Abutments and Walls Adjacent to Bridges

IS EN 1991-2 clause 4.9 as implemented by the National Annex is used and is applied as a surcharge aligned with IS EN 1997. ½RL from AM-STR-06030 (NRA BD 37/15) clause 5.8.2.1 is also used.

6.1.9.7 Flood / Water Loading

Actions caused by water exerted on the structure are applied in accordance with IS EN 1991-1-6 Clause 4.9. The proposed arrangement provides structural integrity and safety under extreme flows in the river.

6.1.9.8 Assessment of Groups of Traffic / Rail Loads (Characteristic Values of the Multicomponent Actions)

Three types of groups of traffic are considered:

1. As a road bridge only i.e. use of gr1a, 1b, 2, 4, 5 and 6 in NA to IS EN 1991-2 Table NA.3,
2. As a light rail (Luas) bridge only with footway and cycle track i.e. IS EN 1991-2 Table 6.11 using the LM71 factors on the characteristic ½RL loading of gr11 to 27, excluding gr15. Where a more onerous load effect results, these are combined with 0.6x characteristic footway and cycle track loading of IS EN 1991-2 NA.2.36.
3. As a combined road and light rail bridge for two cases:
 - a. Characteristic LM1 values and frequent light rail (Luas) values.
 - b. Frequent LM1 and characteristic light rail (Luas).
LM1 and light rail (Luas) are applied to the carriageway in a similar manner to a SV with LM1 in NA to IS EN 1991-2 NA.2.16.4, but with the light rail (Luas) load positioned on the rails only.
4. When the service vehicle (see section 6.1.9.3) is on the bridge. This are combined with:
 - a. The bascule span in the lowered position.
 - b. Frequent LM1 on the carriageway or frequent ½RL or a combination of frequent LM1 and ½RL.
 - c. No other footway or cycle track loading on the same side as the service vehicle, 0.6x characteristic footway and cycle track loading of IS EN 1991-2 NA.2.38 (not LM4) on the far footway and cycle track.

6.2 Authorities Consulted and Any Special Conditions Required

A list of all stakeholders consulted to date by Roughan & O'Donovan or otherwise have had the results of consultations passed onto Roughan & O'Donovan from Dublin

City Council is presented below. Their requirements have been incorporated into the design, but for brevity are not listed here.

Authorities which have been consulted and their requests considered or incorporated into the design are:

- Dublin City Council including:
 - District Heating
 - Architectural design
 - Flooding requirements
 - Liffey Services Tunnel
 - Dark Fibre Network
- National Transport Authority
- Transport Infrastructure Ireland
- Waterways Ireland
- St Patrick's Rowing Club
- Kennedy Wilson (Capital Dock developer)
- Dublin Port Company
- Toll bridge operator requirements
- Utility companies:
 - Gas Networks Ireland
- Commissioners of Irish Lights

Other notable potential stakeholders which have not been consulted are:

- Fáilte Ireland
- An Taisce – The National Trust for Ireland
- An Chomhairle Ealaíon (The Arts Council)
- The Heritage Council
- Development Applications Unit
- Inland Fisheries Ireland
- Córas Iompair Éireann
- Communications, Climate Action & Environment
- Environmental Protection Agency
- Department of Housing, Planning, Community and Local Government
- Commissioners of Public Works in Ireland
- Dublin Bus
- Dublin Docklands Development Authority (DDDA)
- Fisheries Board
- Geological Survey of Ireland
- Bus Éireann
- Tourism Ireland
- Eastern Regional Fisheries Board

A Section 50 Application has been issued to the Office of Public Works on agreement of the preliminary design.

Consultations will continue through the design development process.

6.3 Proposed Departures from Standards

6.3.1 Departure 1 – Vehicular Restraint System

The vehicular restraint system is not compliant to IS EN 1317 and DN-REQ-03034 (NRA TD 19/15). This is because:

- The shallow construction depth required to maintain headroom to the waterway of the bascule span in the closed position whilst limiting approach gradients has resulted in use of a half-through arrangement – upstand box girders. These are positioned between the carriageway and cycle track and act as structural member and vehicle restraints (see departure 2, section 6.3.2).
- In normal operation, the bridge is not open to private or commercial vehicles, but buses and taxis only travelling in a low speed urban environment. This relatively low volume of professionally driven traffic reduces the likelihood of errant vehicles impacting a vehicle restraint system.

This does leave residual risk. Compared to road bridges with compliant systems, there may be higher consequences of errant vehicles causing harm. Whilst the upstand girders are designed to resist impact loads and reduce the likelihood of disproportionate collapse (see section 6.3.2 Departure 2), they are much stiffer than an EN 1337 parapet. Precedent exists elsewhere in Dublin for recently constructed passenger transport bridges without compliant vehicular restraint systems: the Rosie Hackett Bridge.

6.3.2 Departure 2 – Main Structural Members of the Bridge Acting as Vehicle Parapets

The longitudinal upstand box girders protrude above carriageway level with no separate proprietary vehicular restraint system or otherwise between the carriageway and the girders. These main structural elements could be impacted by errant vehicles and hence act as parapets. This is contrary to TII Publications DN-STR-03011-03 NRA BD 52/13 clause 4.6 which states “main structural members of bridges shall not be designed to act as vehicle parapets”.

The depth of the bascule span’s girders is determined from that required as the span cantilevers during bridge opening. Placing the full depth of the girder under the bridge deck would significantly increase the bridge’s structural depth, raising carriageway levels and extending approach further right along Sir John Rogerson’s Quay in an unacceptable manner.

The upstand girders shall follow where feasible the principles of DN-STR-03011 section 9 for bespoke vehicle parapets. They are also designed to align with the principle of EN 1990 clause 2.1(4), namely that they shall be designed and executed in such a way that they will not be damaged by vehicular impact to an extent disproportionate to the original cause. This is achieved by:

- On the carriageway side, a 100 mm kerb being placed 500 mm in front of the girders to reduce the likelihood of minor impacts.
- Adding intermediate transverse diaphragms within the upstand girders to help limit distortion in the event of an impact.
- Specification of steel subgrade of the plates of the upstand using an appropriate strain rate for impact loading in equation 2.3 of IS EN 1993-1-10.
- For global effects, the upstand girders being treated as rigid parapets (see section 6.1.7).

There is precedent in Dublin for a passenger transport bridge where main structural members act as vehicular parapets: the Rosie Hackett Bridge.

6.3.3 Departure 3 – Use of BS 5400-10 for Fatigue Investigation Under RL Loading

Neither EN 1991-2 or EN 1993-1-9 specifically deals with fatigue loading from light rail (Luas). A project specific option could be to develop a project specific light rail fatigue load model and assess it using EN 1993-1-9. However, the superseded (by EN 1993-1-9) and withdrawn BS 5400-10 included a comprehensive method for undertaking fatigue calculations using RL loading. BS 5400-10 is used here. The reduction of RL loading to half magnitude considered at ULS and SLS (see section 6.1.9.1 above) is not to be used: BS 5400-10's fatigue load models are similar to the roughly 10 tonne axles of the current Luas rolling stock.

6.3.4 Departure 4 – Reduced Width of Rubbing Strip

A 500mm rubbing strip provision in the cross section for the bridge and approaches is proposed.

The prescriptive minimum width for a rubbing strip and parapet setback is 600mm according to DN-GEO-03036 "Cross Sections and Headroom" and DN-REQ-03034 "The Design of Road Restraint Systems (Vehicle and Pedestrian) for Roads and Bridges". The justification for this departure from standards is that the aforementioned standard's application is deemed not appropriate on many local and regional roads, such as this roadway, due to the very different traffic conditions and requirements as discussed in Section 6.3.1 and it is deemed a departure or relaxation from standard is appropriate in this regard.

6.4 Proposed Methods of Dealing With Aspects Not Covered by Standards

IS EN 1991-2 does not propose how groups of traffic / rail loads are combined. A proposed method is described in section 6.1.9.8.

Various items specific to bascule bridges are not necessarily envisaged in the Design Manual for Roads and Bridges and the Specification for Road Works.

Given the nature of bascule bridges, a traffic and pedestrian barrier/parapet hinge break joint is required for bridge opening and closing operations. The design of restraint systems of a moveable bascule spans is not specifically addressed in the Design Manual for Roads and Bridges (DMRB). The vehicle road restraint system and the pedestrian/cyclist parapets necessitate a break to allow the opening bridge movement. Use of DN-REQ-03034 (TD19) is required, however, there are strong concerns that this standard is not appropriate on many local roads due to the very different traffic conditions and requirements. TD19 does not address parapets on moveable bridges and therefore is not deemed applicable in this case. An alternative Risk Assessment based approach that is more suitable for City Council controlled roads is deemed appropriate and will be carried out in the detailed design stage. Given the risk level at this low speed environment, the form of parapet provided could be sufficient to reduce the risk but not necessarily fully compliant to EN 1317. It is proposed to provide a standard EN 1317 parapet and a bespoke (upstand) parapet with an appropriate bespoke hinge at the bascule bridge hinge joints in line with common industry standard for similar situations.

The design of expansion joints of a moveable bascule spans is not specifically addressed in the Design Manual for Roads and Bridges (DMRB). For an opening bridge, like that of Dodder Bridge, the opening expansion joints tend to be a "weak spot" on bridge structures. The forward and rear transverse and longitudinal bascule

span carriageway are proposed to be affixed with an elastomeric J-seal to mitigate ingress of debris and water infiltration into the bascule pier and west abutment. Transverse deck joints at footway /cycle tracks are proposed to be affixed similarly with an elastomeric J-seal. A proposed proprietary elastomeric J-seal suitable for this application shall be provided. The system shall be approved for use on road works schemes with appropriate certification. An elastomeric J-seal will mitigate the infiltration of the water and debris but ultimately cannot be fully effective impenetrable to water. Accordingly, the bascule pier chamber will be detailed with a sump pit to drain any water that enters the bascule pier. A pump will be utilised to drain the sump and discharge to the road surface water drainage network. Careful consideration shall be given also to the detailing of the Elastomeric J-seal joint and its incorporation/connection to the structure.

The design as outlined in HD 26/06 "Pavement Design" does not include for thin combined waterproofing/surfacing pavement design, as required for this bridge superstructure. A proprietary combined waterproofing and surfacing system suitable for application on a flexible steel substrate, with adequate anti-skid properties shall be provided. The system shall be approved for use on road works schemes with appropriate certification. For the steel orthotropic deck, a 16mm pavement thickness as carriageway deck surfacing is proposed. Bimagrip LS or equivalent combined surfacing and waterproofing is provided between the kerbs on the bascule bridge. This material is suitable for very heavy traffic conditions. Bimagrip HD or equivalent combined surfacing and waterproofing is provided at the footpaths/cycle track between the kerbs and bridge edge parapets. The Bimagrip and equivalent systems are designed to have long life durability and have performed well on other bascule bridges.

7. GROUND CONDITIONS

7.1 Geotechnical Classification

In accordance with IS EN 1997 and DN-ERW-03083, the scheme is Geotechnical Category 2.

7.2 Description of the Ground Conditions and Compatibility With Proposed Foundation Design

A ground investigation exercise including site works has been undertaken for this project. These site works were undertaken by IGSL Ltd and their subcontractors and is recorded in the IGSL Ltd Factual Report for Project No. 21105. In addition, a general description of the background geology and characteristics of the various formations underlying the project is provided in O'Callaghan Moran & Associates' geo-environmental risk assessment undertaken in October 2018. Interpretation of these results in a Geotechnical Design Report has been completed and is provided in Appendix 3. Based on the results of the various investigations, a preliminary design ground model has been established which is presented below.

IGSL Ltd undertook a total of 18 cable percussion boreholes to a maximum depth of 16 m and 12 rotary core boreholes to a total depth of 31 m at various locations across the footprint of the proposed structure in July/September 2018.

The ground conditions comprise a sequence of variably thick made ground overlying alternate layers of very soft to soft silt and loose silty sand or gravel extending to a significant depth. These overlie stiff to very stiff clay and moderately strong to strong limestone.

ROD developed interpreted geological sections along the main structural elements of the bridge including the west abutment, the bascule pier, and the eastern pier and east abutment. A soil profile summary is presented in Table 7.1.

Table 7.1 Stratigraphic ground model

Typical depth below existing ground (m BGL)	Typical Levels (mOD)	Thickness (m)	Description
0 – 4.7	+3.5 to -1.2	4.7	Made Ground
4.7 – 14.5	-1.2 to -11.0	9.8	Very soft to soft organic Silt
14.5 – 24.5	-11.0 to -21.0	10.0	Stiff to very stiff Clay
Below 24.5	Below -21.0	Not proven	Moderately strong to strong limestone

7.2.1 Soil properties

Soil parameters used for preliminary pile capacity analysis purposes are summarised in Table 7.2. These were derived from a combination of in-situ and laboratory test data as well as empirical relationships.

Table 7.2 Soil parameters

Soil Type	Thickness (m)	γ (kN/m ³)	Drained		Undrained	q_{uc} (MPa)	RQD (%)
			c' (kPa)	ϕ' (°)	c_u (kPa)		
Made Ground	4.7	15	-	-	-	-	-
Organic Silt	9.8		-	-	-	-	-
Stiff Clay	10.0	22	-	-	100	-	-
Limestone		25	-	-	-	30	50

For the purpose of assessing preliminary pile capacities, the made ground and the organic silt have been presumed not to contribute to the load-carrying capacity for the piles.

7.2.2 Bedrock Conditions

The proposed location is predominately underlain by Calp limestone of the carboniferous era. The rock layer is mainly characterised as moderately strong to strong rock, with uniaxial compressive strength typically ranging up to a maximum of 300 MN/m²; however interbedded layers of weak mudstone could drop this value down to 30 MN/m². According to Geological Survey Ireland the rock stratum is classified as a Locally Important Aquifer (LI).

The layer was encountered at weathering state at levels as shallow as -16.7 mOD, however because of the presence of thick clay infills the solid rock head level is considered at -21 mOD.

7.2.3 Groundwater

Groundwater was encountered generally between 3.5m and 3.8m below ground level (BGL) at BH501 and BH517, respectively. According to Geological Survey Ireland records the groundwater vulnerability at this site is described as low.

7.2.4 Describe the Proposals for the Foundations

Both piers and both abutments have similar ground conditions. However, the load intensity varies being more considerable on the bascule pier. On that basis and considering the comparably poor ground conditions for the top 10 m, the available foundation alternatives are reduced to the piling solution in order to limit any potential long-term settlements by achieving adequate bearing within the underlying bedrock. Construction of both bored cast-in-place and drilled-in tubular steel piles is considered technically feasible at this site and could enable drilling into bedrock to achieve sufficient end bearing capacity. The standard CFA system is discounted in this case as it could result in refusal before reaching the design depth. Should any of the above solutions be adopted then temporary steel casing would be necessary to provide stability of the bore during drilling given the presence of groundwater strikes within the superficial deposits. In addition, an appropriate technique should be adopted to drill into rock to achieve rough socket walls. It is recommended that bored pile option is adopted for several reasons, as it causes minimal ground disturbance as well as vibration or noise during installation, while it can offer relatively high capacities with more economy. Minimal ground disturbance is markedly important where piling around the service tunnels / pipeline.

8. DRAWINGS AND DOCUMENTS

8.1 List of all Documents Accompanying the Submission

Drawings – Engineering

Number	Revision	Title
DPTB-ROD-HGN-SWE-DRG-CH-210101	P01	SITE LOCATION PLAN
DPTB-ROD-HGN-SWE-DRG-CH-210111	P01	VERTICAL AND HORIZONTAL ALIGNMENT
DPTB-ROD-HGN-SWE-DRG-CH-210121	P01	EXISTING SERVICES PLAN
DPTB-ROD-HGN-LRN-DRG-CH-210131	P01	EAST JUNCTION LAYOUT & PEDESTRIAN/CYCLE ROUTES
DPTB-ROD-SBR-SWE-DRG-CB-210201	P01	BRIDGE AND APPROACHES GENERAL LAYOUT
DPTB-ROD-SBR-DOB-DRG-CB-210202	P01	DODDER BRIDGE GENERAL ARRANGEMENT - SHEET 1
DPTB-ROD-SBR-DOB-DRG-CB-210203	P01	DODDER BRIDGE GENERAL ARRANGEMENT - SHEET 2
DPTB-ROD-SBR-DOB-DRG-CB-210204	P01	DODDER BRIDGE GENERAL ARRANGEMENT - SHEET 3
DPTB-ROD-SBR-DOB-DRG-CB-210205	P01	DODDER BRIDGE GENERAL ARRANGEMENT - SHEET 4
DPTB-ROD-SBR-DOB-DRG-CB-210206	P01	DODDER BRIDGE GENERAL ARRANGEMENT - SHEET 5
DPTB-ROD-SBR-LRN-DRG-CB-210301	P01	RECLAIMED LAND GENERAL ARRANGEMENT - SHEET 1
DPTB-ROD-SBR-LRN-DRG-CB-210302	P01	RECLAIMED LAND GENERAL ARRANGEMENT - SHEET 2
DPTB-ROD-SBR-LRN-DRG-CB-210303	P01	RECLAIMED LAND GENERAL ARRANGEMENT - SHEET 3
DPTB-ROD-SBR-SWE-DRG-CV-210401	P01	SCHEME CONSTRUCTION SEQUENCE SHEET 1
DPTB-ROD-SBR-SWE-DRG-CV-210402	P01	SCHEME CONSTRUCTION SEQUENCE SHEET 2
DPTB-ROD-SBR-SWE-DRG-CV-210403	P01	SCHEME CONSTRUCTION SEQUENCE SHEET 3
DPTB-ROD-SBR-SWE-DRG-CV-210404	P01	SCHEME CONSTRUCTION SEQUENCE SHEET 4
DPTB-ROD-SBR-SWE-DRG-CV-210405	P01	SCHEME CONSTRUCTION SEQUENCE SHEET 5
DPTB-ROD-SBR-SWE-DRG-CV-210406	P01	SCHEME CONSTRUCTION SEQUENCE SHEET 6

Drawings – Architectural

Number	Revision	Title

8.2 Other Documents

Other documents referenced in this report but, for brevity, do not accompany the submission are listed below.

Ref	Name	Revision	Date	Author
60501943	East Link (Tom Clarke) Bridge Pedestrian and Cycling Facilities, Point Pedestrian & Cycling Bridge, Options Report	C	November 2017	AECOM
-	Tier 1 Risk Assessment, Proposed Dodder Bridge	-	31 October 2018	O'Callaghan Moran & Associates
DPTB-ROD-C1-SWE-RPT-CV-00005	Dodder Public Transportation Opening Bridge, Options Study Report	06	May 2019	ROD
DPTB-ROD-C1-SWE-RPT-CV-00025	Dodder Public Transportation Opening Bridge, Eastern Junction Options Study	03	June 2019	ROD
21105	Dodder Public Transportation Opening Bridge, Ground Investigation, Factual Report	0	November 2019	IGSL Ltd
-	Standard Slipway (2012)	-	November 2012	Inland Waterways Association (UK)

APPENDIX 1 PHOTOGRAPHS



Photograph 1 Looking northwest towards Tom Clarke Bridge over the area which becomes reclaimed land.



Photograph 2 Looking south into the mouth of the River Dodder from the north bank of the Liffey.



Photograph 3 Looking north along the Dodder towards the bridge site.



Photograph 4 Looking onto Britain Quay at the proposed location of the west abutment with Sir John Rogerson's Quay on the right.



Photograph 5 Looking south from the Liffey onto the area which becomes reclaimed land. St Patrick's Rowing Club building is on the left.



Photograph 6 St Patrick's Rowing Club building



Photograph 7 Access hatch to the 2018 service tunnel shaft and gas main

APPENDIX 2 DRAWINGS

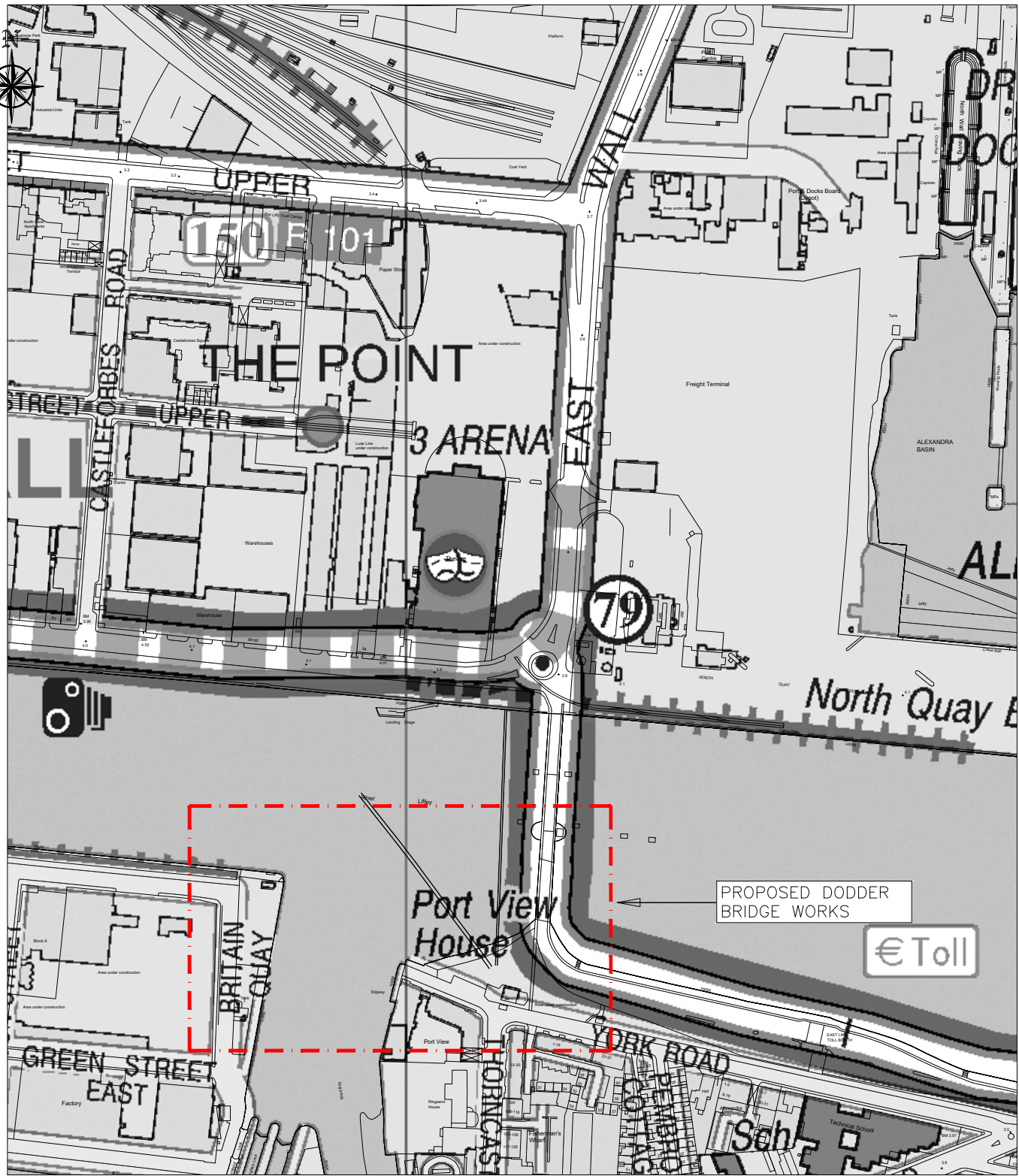

DUBLIN STREET MAP
SCALE 1:2000 A1
SCALE 1:4000 A3



AERIAL IMAGE
SCALE 1:2000 A1
SCALE 1:4000 A3

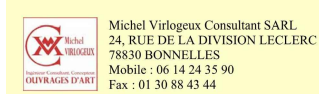

No.	Revision	Date	By	Chk'd	App'd
P01	FOR ACCEPTANCE	22.09.20	DO	JK	TD
P02	ISSUED FOR REVIEW	26.01.21	OB	JK	TD



Arena House, Arena Road, Sandycove, Dublin 18, Ireland
t +353 (0) 1 294 0800
f +353 (0) 1 294 0820
www.rod.ie

Drawn	Designed	Checked	Approved	Suitability Code - Description
PE	PM	JK	TD	S3 - For Acceptance

Project Title	DODDER PUBLIC TRANSPORTATION OPENING BRIDGE					
Drawing Title	SITE LOCATION PLAN					
Drawing Number	Project	Originator	Volume	Location	Type	Role Number
	DPTB	ROD	HGN	SWE	DRG - CH	210101
Scale (A1)	AS SHOWN	Date:	SEP 2020	Job No:	17143	Rev: P02

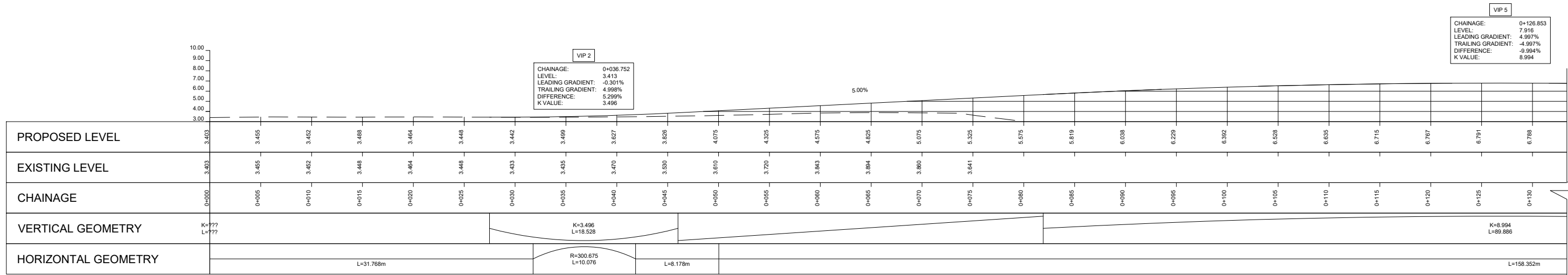

ALIGNMENT PROFILE
SCALE 1:200 HORIZONTAL 1:200 VERTICAL

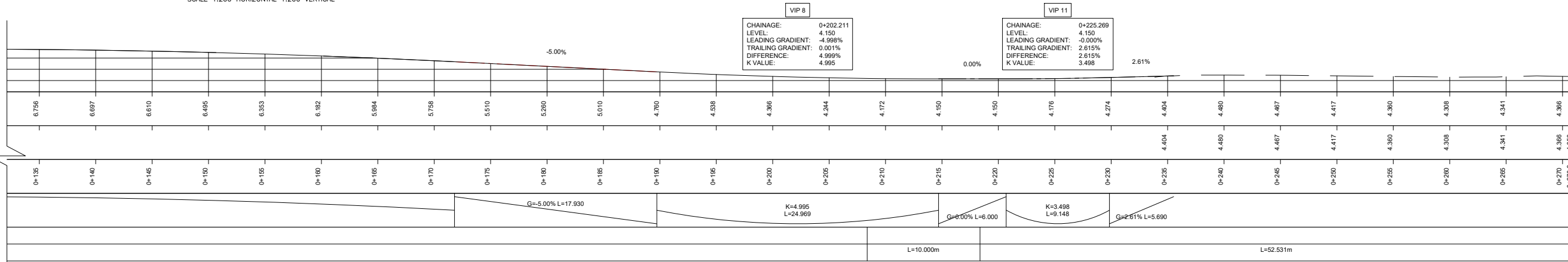

ALIGNMENT PROFILE (CONT'D)
SCALE 1:200 HORIZONTAL 1:200 VERTICAL

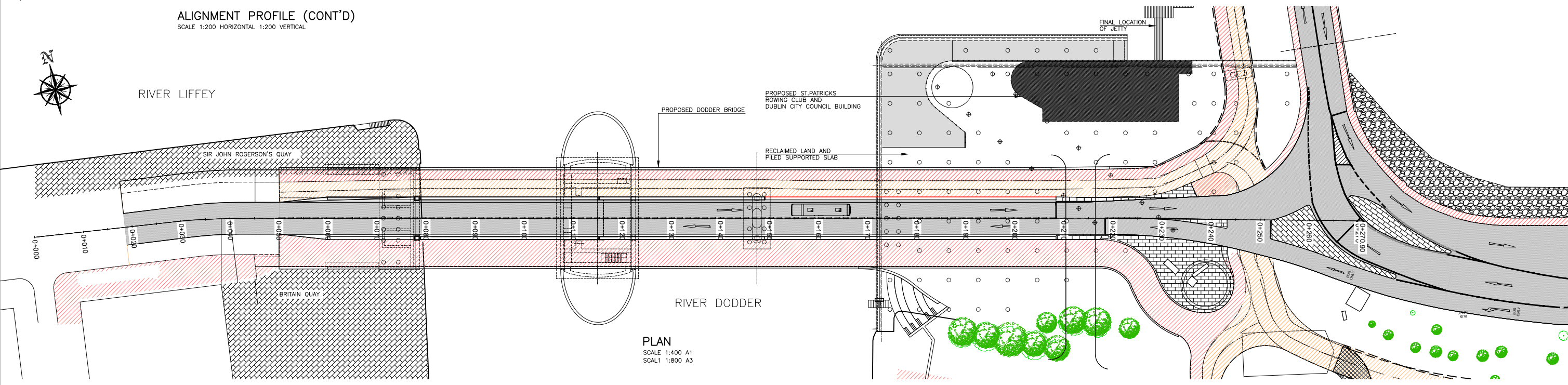

VIP 5

CHAINAGE:	0+126.853
LEVEL:	7.916
LEADING GRADIENT:	4.997%
TRAILING GRADIENT:	-4.997%
DIFFERENCE:	-9.994%
K VALUE:	8.994

VIP 2

CHAINAGE:	0+036.752
LEVEL:	3.413
LEADING GRADIENT:	-0.301%
TRAILING GRADIENT:	4.998%
DIFFERENCE:	5.299%
K VALUE:	3.496

VIP 8

CHAINAGE:	0+202.211
LEVEL:	4.150
LEADING GRADIENT:	-4.998%
TRAILING GRADIENT:	0.001%
DIFFERENCE:	4.999%
K VALUE:	4.995

VIP 11

CHAINAGE:	0+225.269
LEVEL:	4.150
LEADING GRADIENT:	-0.000%
TRAILING GRADIENT:	2.615%
DIFFERENCE:	2.615%
K VALUE:	3.498



			<table border="1"> <thead> <tr> <th>No.</th> <th>Revision</th> <th>Date</th> <th>By</th> <th>Chk'd</th> <th>App'd</th> </tr> </thead> <tbody> <tr> <td>P01</td> <td>FOR ACCEPTANCE</td> <td>22.09.20</td> <td>DQ</td> <td>JK</td> <td>TD</td> </tr> <tr> <td>P02</td> <td>ISSUED FOR REVIEW</td> <td>26.01.21</td> <td>OB</td> <td>JK</td> <td>TD</td> </tr> </tbody> </table>					No.	Revision	Date	By	Chk'd	App'd	P01	FOR ACCEPTANCE	22.09.20	DQ	JK	TD	P02	ISSUED FOR REVIEW	26.01.21	OB	JK	TD		Arena House, Arena Road, Sandyford, Dublin 18, Ireland t +353 (0) 1 294 0800 f +353 (0) 1 294 0820 www.rod.ie	Project Title DODDER PUBLIC TRANSPORTATION OPENING BRIDGE
			No.	Revision	Date	By	Chk'd	App'd																				
P01	FOR ACCEPTANCE	22.09.20	DQ	JK	TD																							
P02	ISSUED FOR REVIEW	26.01.21	OB	JK	TD																							
Drawing Title VERTICAL AND HORIZONTAL ALIGNMENT																												
Drawing Number DPTB - ROD - HGN - SWE - DRG - CH - 210111			Project Originator Volume Location Type Role Number DPTB - ROD - HGN - SWE - DRG - CH - 210111					Drawing Number DPTB - ROD - HGN - SWE - DRG - CH - 210111																				
Scale (A1) AS SHOWN			Date: SEP 2020					Job No: 17143	Rev: P02																			

DO NOT SCALE USE FIGURED DIMENSIONS ONLY

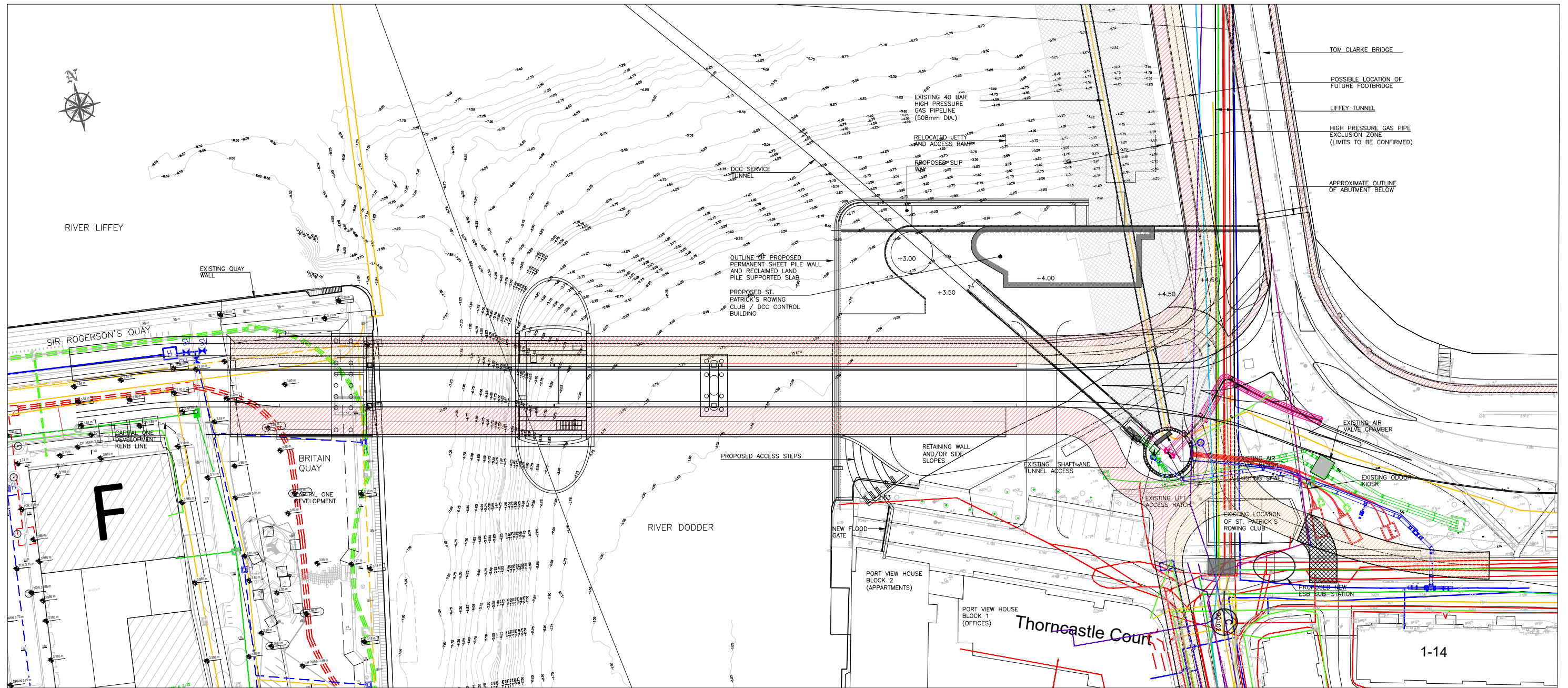

EXISTING SERVICES PLAN
SCALE 1:400

NOTES :

- 4.15MOD (MALIN) - IS THE FLOOD DEFENCE LEVEL BY DCC
- 3.25 MOD (MALIN - 120 YEAR FLOOD LEVEL BY DCC
- FILL BEHIND BRITAIN QUAY IS RECLAIMED. STABILITY OF QUAY WALLS WILL BE CRITICAL
- WWI REQUIREMENTS - (A) 19M NAVIGATION CHANNEL (9M+5M EITHER SIDE)
(B) NAVIGATIONAL CLEARANCE REQUIREMENT IN HIGH TIDE CONDITION FOR CRAFTS WHEN BRIDGE IS CLOSED - THE TYPICAL DRAFT IS 1.5M AND ADDITIONAL 0.6M SHOULD BE GUARANTEED BETWEEN THE KEEL AND THE RIVER BED. THE AIRDRAFT IS TYPICALLY 2.7M
- THE CONTRACTOR TO CONFIRM LOCATION OF SERVICES PRIOR TO CONSTRUCTION OF PERMANENT AND TEMPORARY WORKS

LEGEND:

- | | | | |
|--|----------------------|--|--------------|
| | DISTRICT HEATING | | COLT |
| | WATER | | VIRGIN MEDIA |
| | WATER PROPOSED | | VODAFONE |
| | GAS | | E-NET |
| | GAS | | BT |
| | ESB | | |
| | ESB PROPOSED | | |
| | DRAINAGE | | |
| | TELECOM/EIR | | |
| | TELECOM/EIR PROPOSED | | |

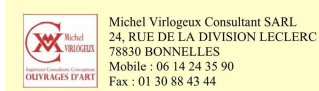

Arena House, Arena Road, Sandyford, Dublin 18, Ireland
t +353 (0) 1 294 0800
f +353 (0) 1 294 0820
www.rod.ie

No.	Revision	Date	By	Chk'd	App'd
P01	FOR ACCEPTANCE	22.09.20	DQ	JK	TD
P02	ISSUED FOR REVIEW	26.01.21	OB	JK	TD

Drawn	Designed	Checked	Approved	Suitability Code - Description
PE	CS	JK	TD	S3 - For Acceptance

Project Title		DODDER PUBLIC TRANSPORTATION OPENING BRIDGE					
Drawing Title		EXISTING SERVICES PLAN					
Project Number	Originator	Volume	Location	Type	Role	Number	
DPTB	ROD	HGN	SWE	DRG	CH	210121	
Scale (A1)	AS SHOWN	Date:	Sept 2020	Job No:	17143	Rev:	P02

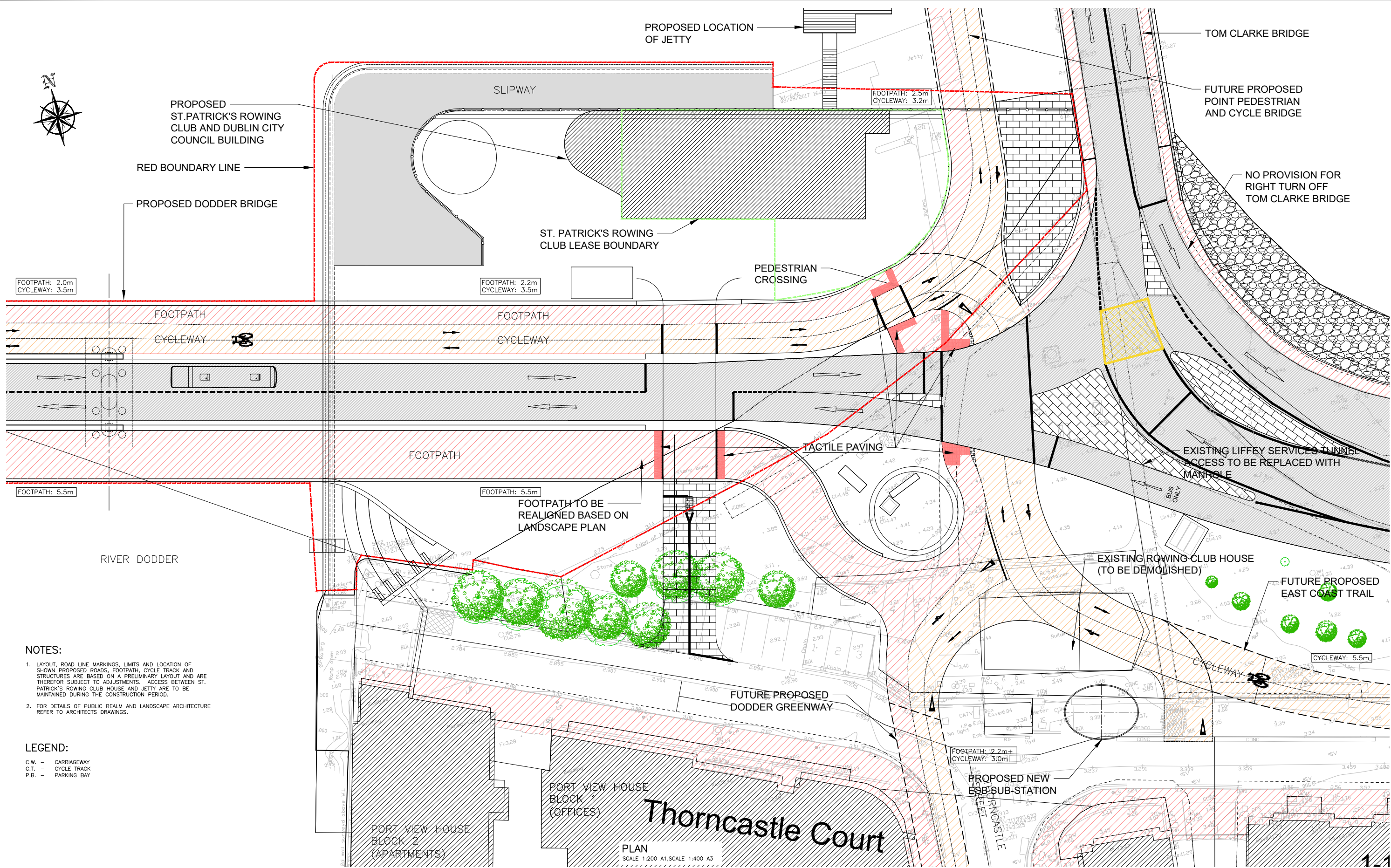

FOOTPATH: 2.0m
CYCLEWAY: 3.5m

FOOTPATH: 2.2m
CYCLEWAY: 3.5m

FOOTPATH: 2.5m
CYCLEWAY: 3.2m

FOOTPATH: 5.5m

FOOTPATH: 5.5m

FOOTPATH: 2.2m+
CYCLEWAY: 3.0m

FOOTPATH: 5.5m
CYCLEWAY: 5.5m

- NOTES:**
- LAYOUT, ROAD LINE MARKINGS, LIMITS AND LOCATION OF SHOWN PROPOSED ROADS, FOOTPATH, CYCLE TRACK AND STRUCTURES ARE BASED ON A PRELIMINARY LAYOUT AND ARE THEREFOR SUBJECT TO ADJUSTMENTS. ACCESS BETWEEN ST. PATRICK'S ROWING CLUB HOUSE AND JETTY ARE TO BE MAINTAINED DURING THE CONSTRUCTION PERIOD.
 - FOR DETAILS OF PUBLIC REALM AND LANDSCAPE ARCHITECTURE REFER TO ARCHITECTS DRAWINGS.

- LEGEND:**
- C.W. - CARRIAGEWAY
 - C.T. - CYCLE TRACK
 - P.B. - PARKING BAY

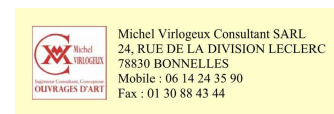

No.	Revision	Date	By	Chk'd	App'd
P01	FOR ACCEPTANCE	22.09.20	DQ	JK	TD
P02	ISSUED FOR REVIEW	26.01.21	OB	JK	TD



Arena House, Arena Road, Sandycove, Dublin 18, Ireland
t +353 (0) 1 294 0800
f +353 (0) 1 294 0820
www.rod.ie

Project Title						DODDER PUBLIC TRANSPORTATION OPENING BRIDGE									
Drawing Title						EAST JUNCTION LAYOUT & PEDESTRIAN/CYCLE ROUTES									
Project	Originator	Volume	Location	Type	Role	Number	Project	Originator	Volume	Location	Type	Role	Number		
DPTB	ROD	HGN	LRN	DRG	CH	210131	DPTB	ROD	HGN	LRN	DRG	CH	210131		
Scale (A1)		AS SHOWN		Date:		Sept 2020		Job No:		17143		Rev:		P02	

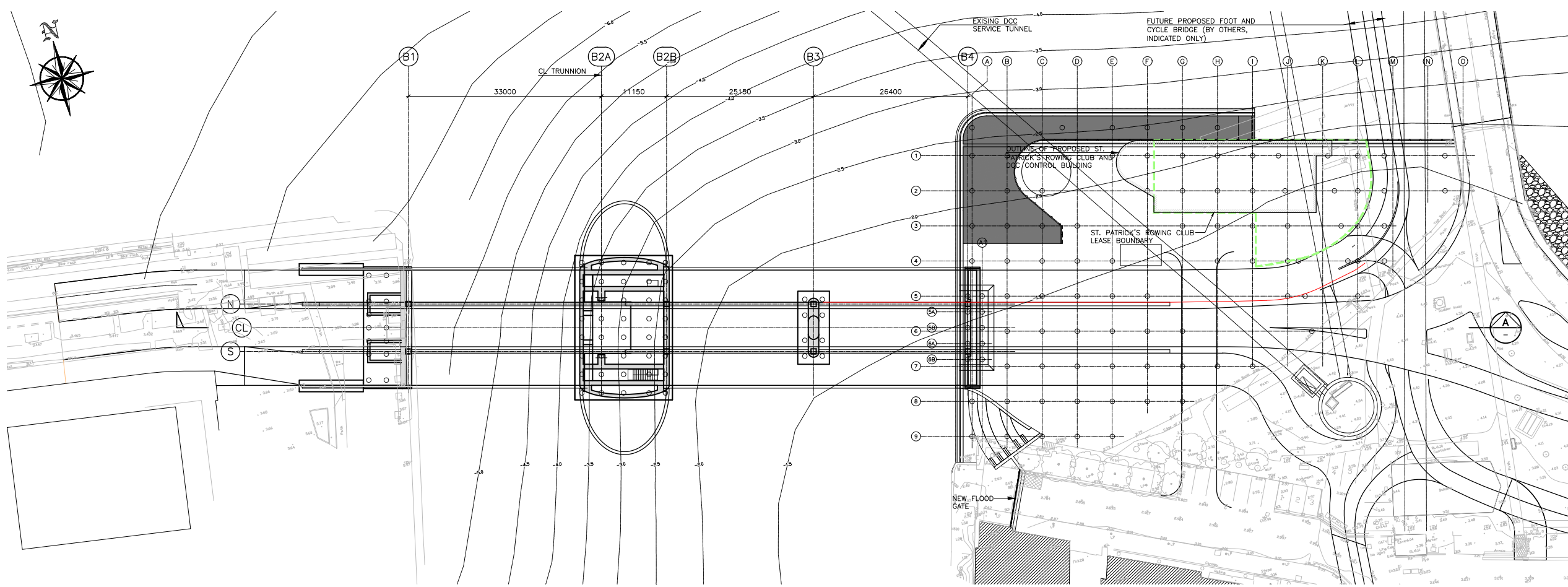

GENERAL SUBSTRUCTURE BRIDGE PLAN
SCALE 1:400

- NOTES:
1. FINAL DEPTH AND ARRANGEMENT OF PILES SUBJECT TO DETAILED DESIGN.
 2. FOR DETAILS OF PUBLIC REALM REFER TO ARCHITECTURAL LANDSCAPING DRAWINGS.
 3. FOR DETAILS OF PROPOSED ST. PATRICK'S ROWING CLUB DCC CONTROL BUILDING REFER TO BUILDING DRAWINGS.
 4. DETAILS OF EXISTING QUAY WALL IS SHOWN INDICATIVELY AND WILL BE CONFIRMED ON SITE. THE EXISTING QUAY WALL WILL BE PROVIDED WITH TEMPORARY PROTECTION DURING CONSTRUCTION.
 5. THE WATERPROOFING OF CONCRETE STRUCTURES WILL BE IN ACCORDANCE WITH THE SPECIFICATION OF ROAD WORKS SERIES 2000.
 6. FURTHER INFORMATION REGARDING THE PUBLIC REALM AND PROPOSED BUILDING REFER TO ARCHITECT'S DRAWINGS.
 7. ALL BRIDGE ABUTMENTS AND EACH RETAINING WALL STRUCTURE IN THE DESIGN SHALL BE PROVIDED WITH A POSITIVE DRAINAGE SYSTEM TO EACH FACE IN ACCORDANCE WITH THE SPECIFICATION AND SUCH DRAINAGE SHALL INCLUDE PROVISION FOR FUTURE ACCESS AND RODDING. BACK OF STRUCTURE DRAINAGE TO BE POSITIVELY DRAINED AND TO TIE INTO THE MAINLINE DRAINAGE NETWORK.

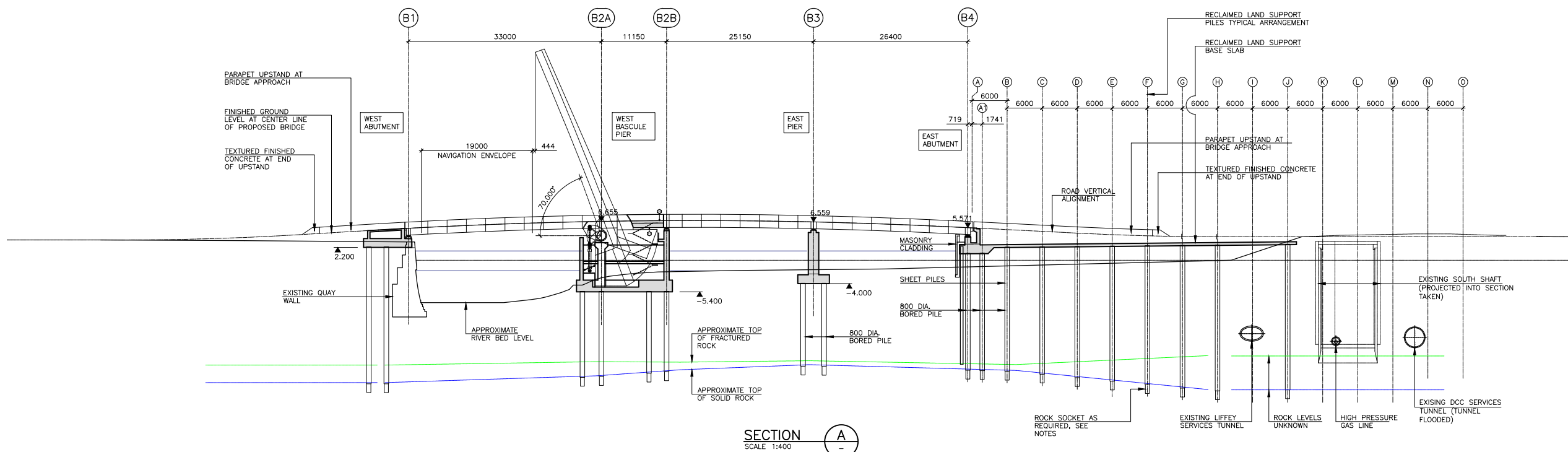

SECTION A
SCALE 1:400



No.	Revision	Date	By	Chkd	App'd
P01	FOR ACCEPTANCE	22.09.20	DQ	JK	TD
P02	ISSUED FOR REVIEW	26.01.21	OB	JK	TD



Arena House, Arena Road, Sandyford, Dublin 18, Ireland
t +353 (0) 1 294 0800
f +353 (0) 1 294 0820
www.rod.ie

Drawn	Designed	Checked	Approved	Suitability Code - Description
PE	JK	JK	TD	S3 - For Acceptance

Project Stage	PRELIMINARY DESIGN				
Project Title	DODDER PUBLIC TRANSPORTATION OPENING BRIDGE				
Drawing Title	BRIDGE AND APPROACHES GENERAL LAYOUT				
Drawing Number	Project	Originator	Volume	Location	Type Role Number
	DPTB	ROD	SBR	SWE	DRG - CB - 210201
Scale (A1)	AS SHOWN	Date:	Sept. 2020	Job No:	17.143
				Rev:	P02

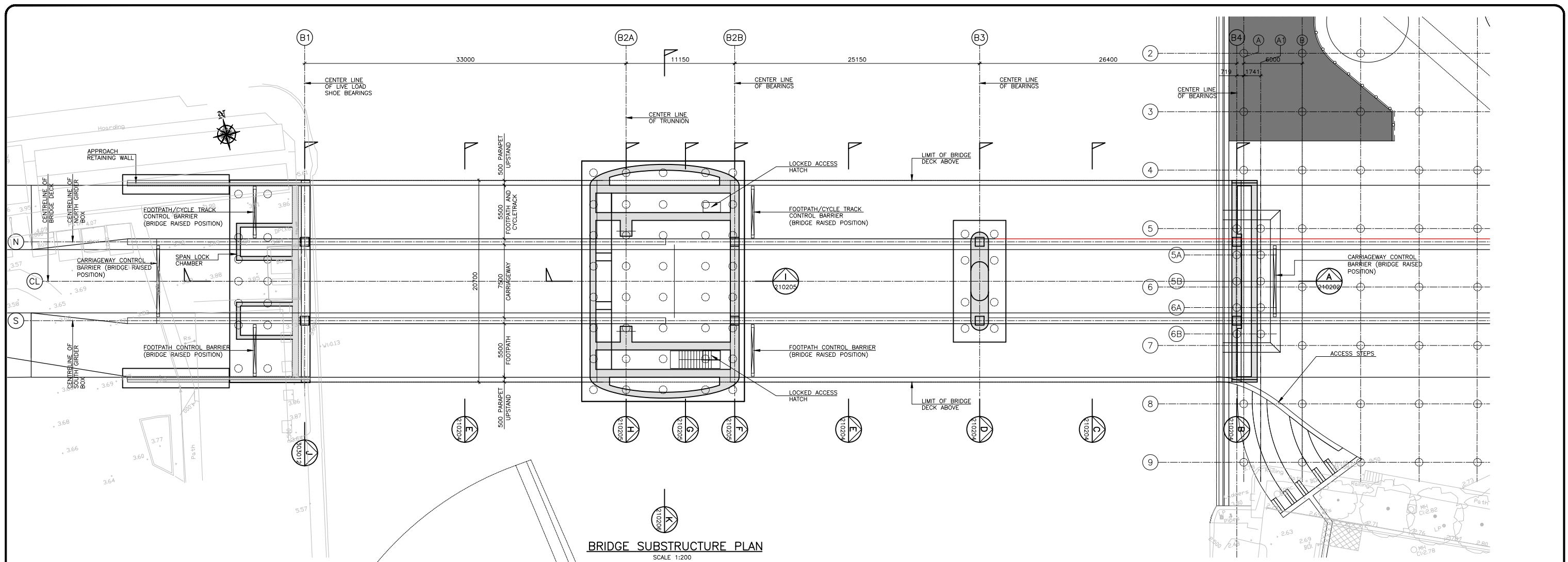

BRIDGE SUBSTRUCTURE PLAN
SCALE 1:200

NOTES:

1. THE DESIGN INTENT IS FOR THE CONTRACTOR TO USE ACCEPTED INDUSTRY METHODS TO ACHIEVE ALIGNMENT TOLERANCE FOR PROPER OPERATION OF A REPEATABLE OPERATING SYSTEM, INCLUDING COORDINATION ALL MECHANICAL, ELECTRICAL AND STRUCTURAL INTERFACE POINTS. ALL RIGGING SCAFFOLDING, MEASUREMENTS, ALIGNMENT AND INSTALLATION TOOLS REQUIRED FOR THE JOB ARE CONSIDERED PART OF THE WORK. FINAL MACHINERY INSTALLATION SHALL RESULT IN PROPER FUNCTION THROUGHOUT THE COMPLETE RANGE OF OPERATION. MACHINERY INSTALLERS SHALL BE INVOLVED WITH THE INSTALLATION OF ANY STRUCTURAL STEEL FOR THE MOVABLE SPAN IN ORDER TO IDENTIFY AND COORDINATE THE STEEL ERECTION ITEMS THAT WILL AFFECT THE MACHINERY INSTALLATION.
2. THE CONTRACTOR SHALL PREPARE AND SUBMIT DETAILED SHOP AND ASSEMBLY DRAWINGS BASED ON THE CONTRACT DRAWINGS AND SPECIFICATIONS FOR APPROVAL. IT WILL BE THE CONTRACTOR'S RESPONSIBILITY TO DETAIL, COORDINATE AND VERIFY THE RELATIONSHIP AND ASSEMBLY OF ALL PARTS FOR A COMPLETE WORKING SYSTEM. ALL REQUIRED MACHINING, SPECIAL SHIMMING, LUBRICATION, PAINTING, TESTING AND ASSEMBLY SHALL BE CONSIDERED PART OF THE WORKS.
3. PROVIDE SHIMS FOR LEVELING AND ALIGNING OF ALL MACHINERY. SHIMS SHALL BE 13mm NOMINAL THICKNESS, UNLESS OTHERWISE SPECIFIED, WITH ADJUSTMENT VARIATIONS AS DESCRIBED ON THE INDICATED PLANS, WITH ADJUSTMENTS AS DESCRIBED IN THE SPECIFICATIONS.
4. DURING NORMAL OPERATIONS, EACH SPAN LOCK MACHINERY ASSEMBLY IS DESIGNED TO SIMULTANEOUSLY DISENGAGE / ENGAGE RECEIVING SOCKETS LOCATED AT THE TOE OF THE ADJOINING LEAF WITH THE LEAVES CLOSED.

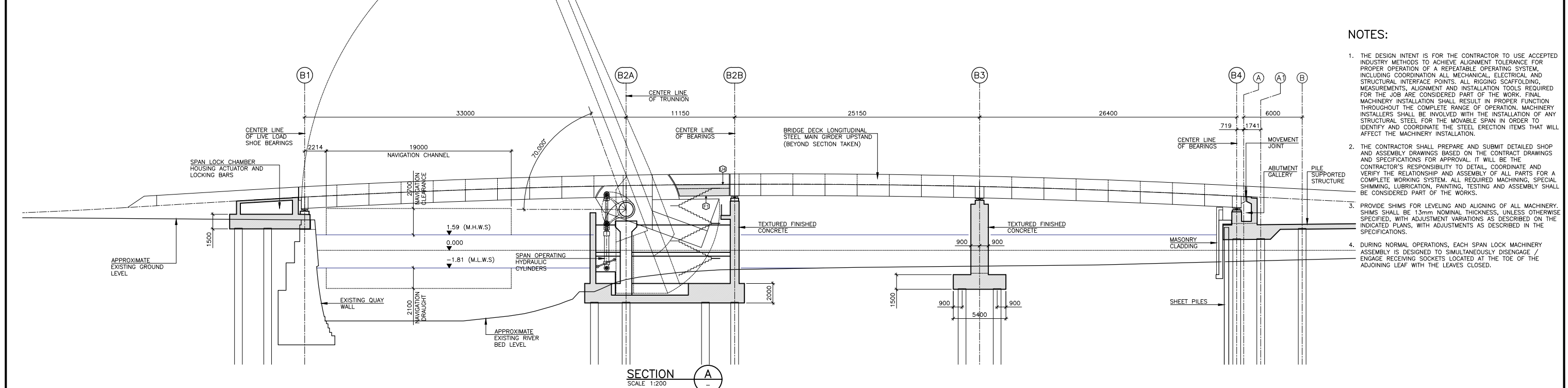

SECTION A
SCALE 1:200



No.	Revision	Date	By	Chkd	App'd
P01	FOR ACCEPTANCE	22.09.20	DQ	JK	TD
P02	ISSUED FOR REVIEW	26.01.21	OB	JK	TD



Arena House, Arena Road, Sandyford, Dublin 18, Ireland
t +353 (0) 1 294 0800
f +353 (0) 1 294 0820
www.rod.ie

Drawn	Designed	Checked	Approved	Suitability Code - Description
PE	JK	JK	TD	S3 - For Acceptance

Project Stage	PRELIMINARY DESIGN				
Project Title	DODDER PUBLIC TRANSPORTATION OPENING BRIDGE				
Drawing Title	DODDER BRIDGE GENERAL ARRANGEMENT - SHEET 1				
Drawing Number	Project	Originator	Volume	Location	Type Role Number
	DPTB	ROD	SBR	DOB	DR - CB - 210202
Scale (A1)	AS SHOWN	Date:	Sept 2020	Job No:	17.143
				Rev:	P02

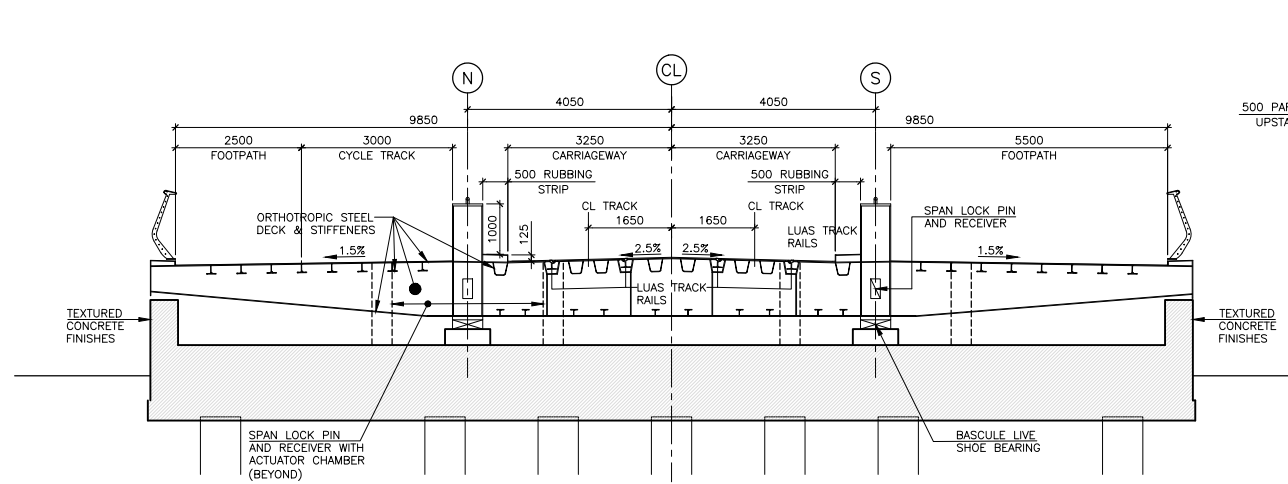

SECTION J
SCALE 1:75

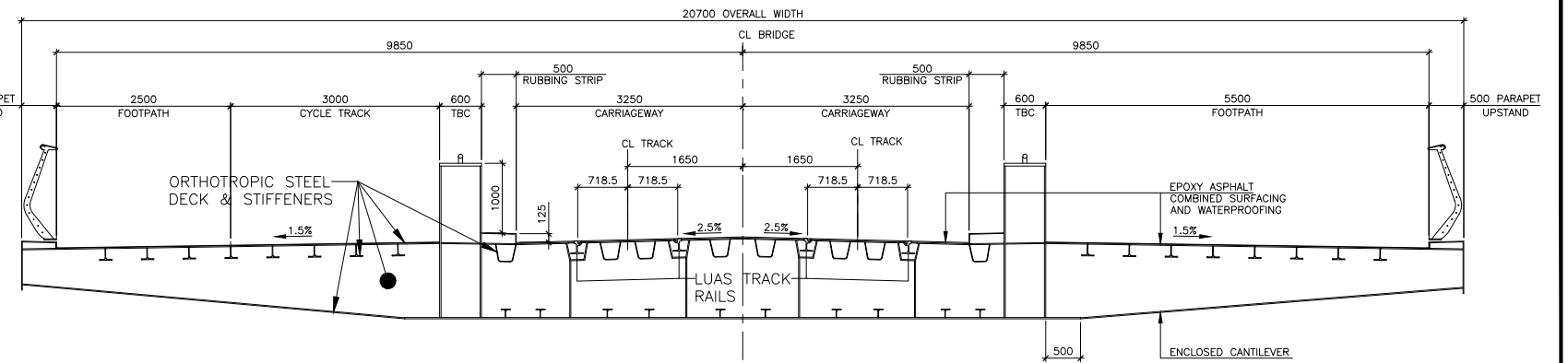

BRIDGE DECK TYPICAL CROSS SECTION
SCALE 1:50

NOTES:

1. EXACT LENGTH OF BARRIER SHALL BE CONFIRMED IN THE DETAILED DESIGN STAGE AND AGREED WITH DUBLIN CITY COUNCIL
2. ALTERNATIVE LONGITUDINAL STIFFENER DETAIL SHALL BE CONSIDERED AT THE DETAILED DESIGN STAGE
3. BARRIER POST SPACING SHALL MATCH TRANSVERSE / DIAPHRAGM BEAM SPACING
4. FINAL LOCATION OF THE CONTROL BARRIERS TO BE CONFIRMED IN THE DETAILED DESIGN STAGE

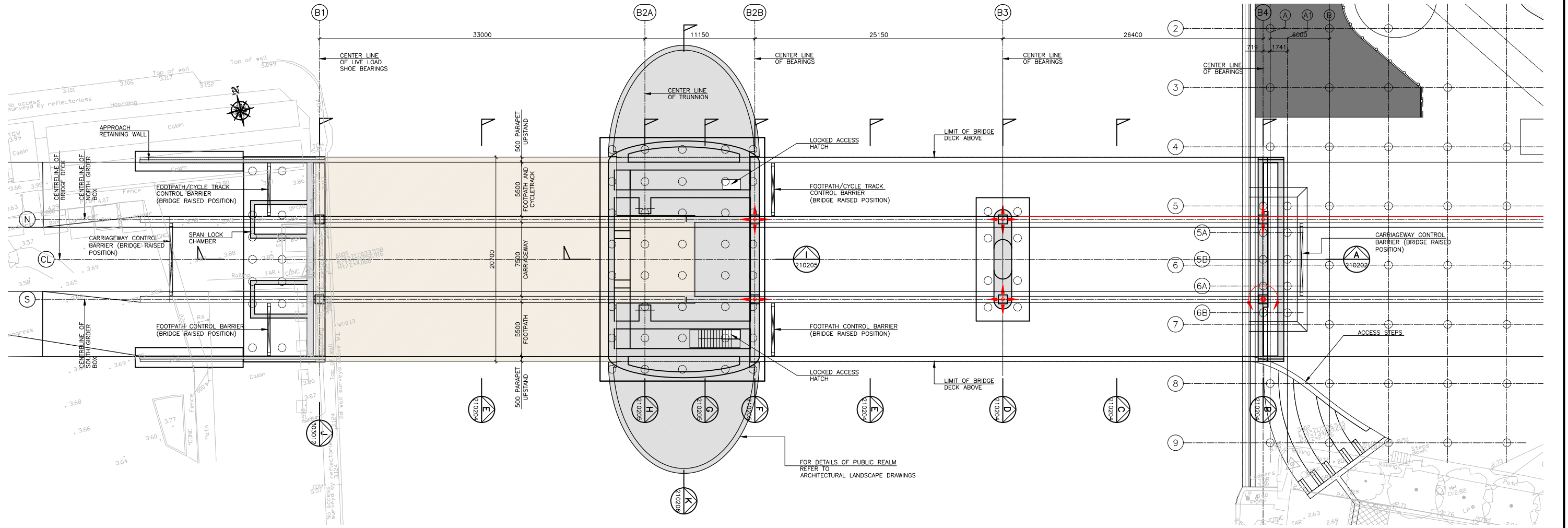

BRIDGE SUPERSTRUCTURE PLAN
SCALE 1:200



No.	Revision	Date	By	Chk'd	App'd
P01	FOR ACCEPTANCE	22.09.20	DQ	JK	TD
P02	ISSUED FOR REVIEW	26.01.21	OB	JK	TD



Civil - Structural - Transportation - Environmental

Arena House, Arena Road, Sandyford, Dublin 18, Ireland
t +353 (0) 1 294 0800
f +353 (0) 1 294 0820
www.rod.ie

Drawn	Designed	Checked	Approved	Suitability Code - Description
PE	JK	JK	TD	S3 - For Acceptance

Project Stage	PRELIMINARY DESIGN				
Project Title	DODDER PUBLIC TRANSPORTATION OPENING BRIDGE				
Drawing Title	DODDER BRIDGE GENERAL ARRANGEMENT - SHEET 2				
Drawing Number	DPTB	ROD	SBR	DOB	DR - CB - 210203
Scale (A1)	AS SHOWN	Date:	Sept 2020	Job No:	17.143
				Rev:	P02

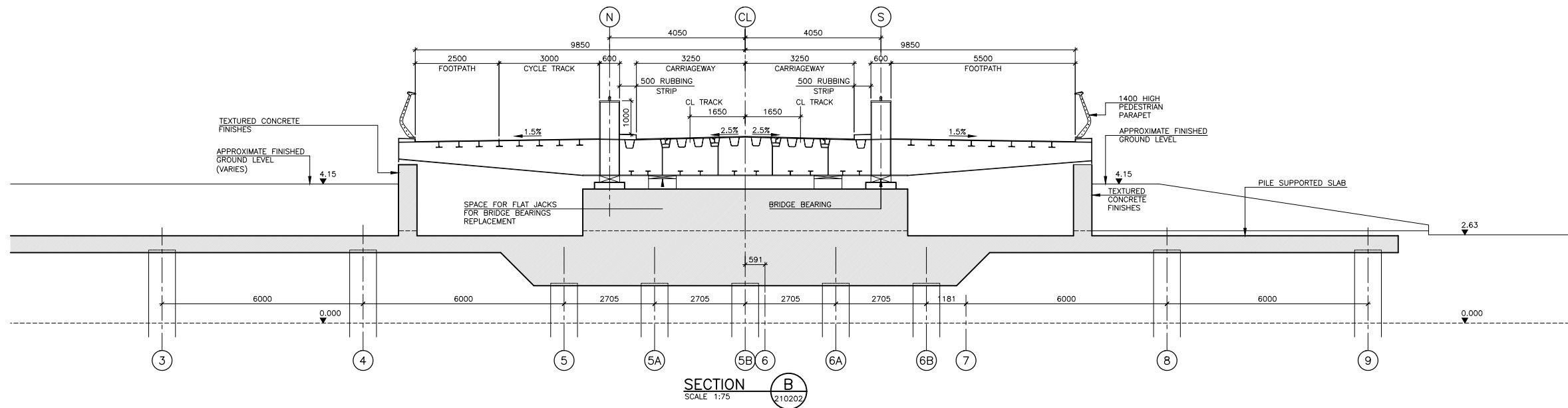

SECTION B
SCALE 1:75
210202

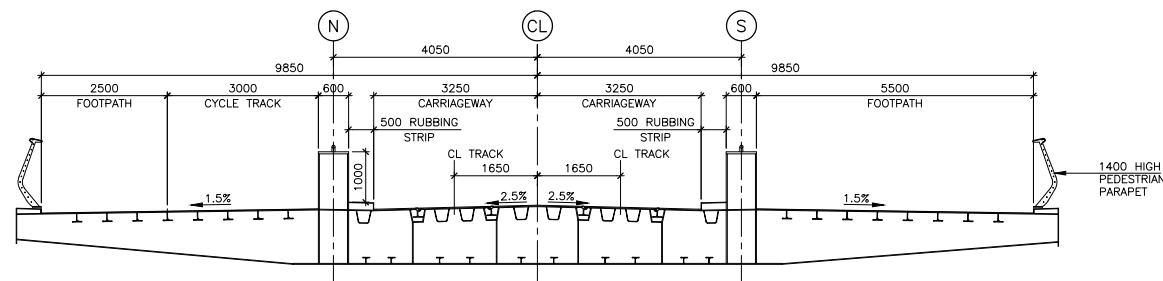

SECTION C
SCALE 1:75
210202

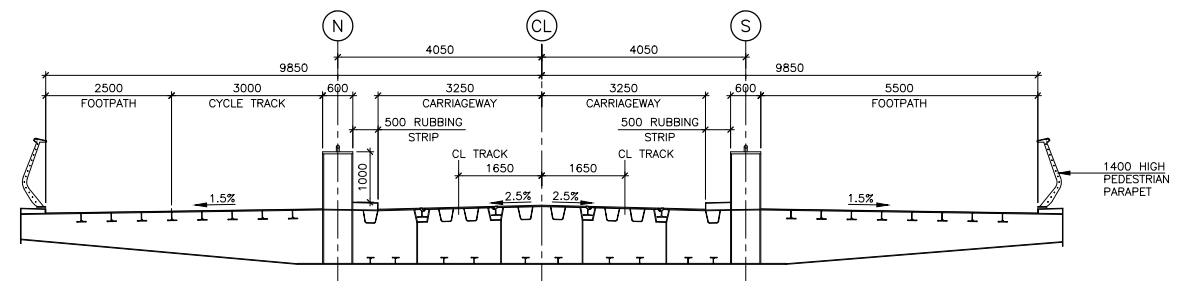

SECTION E
SCALE 1:75
210202

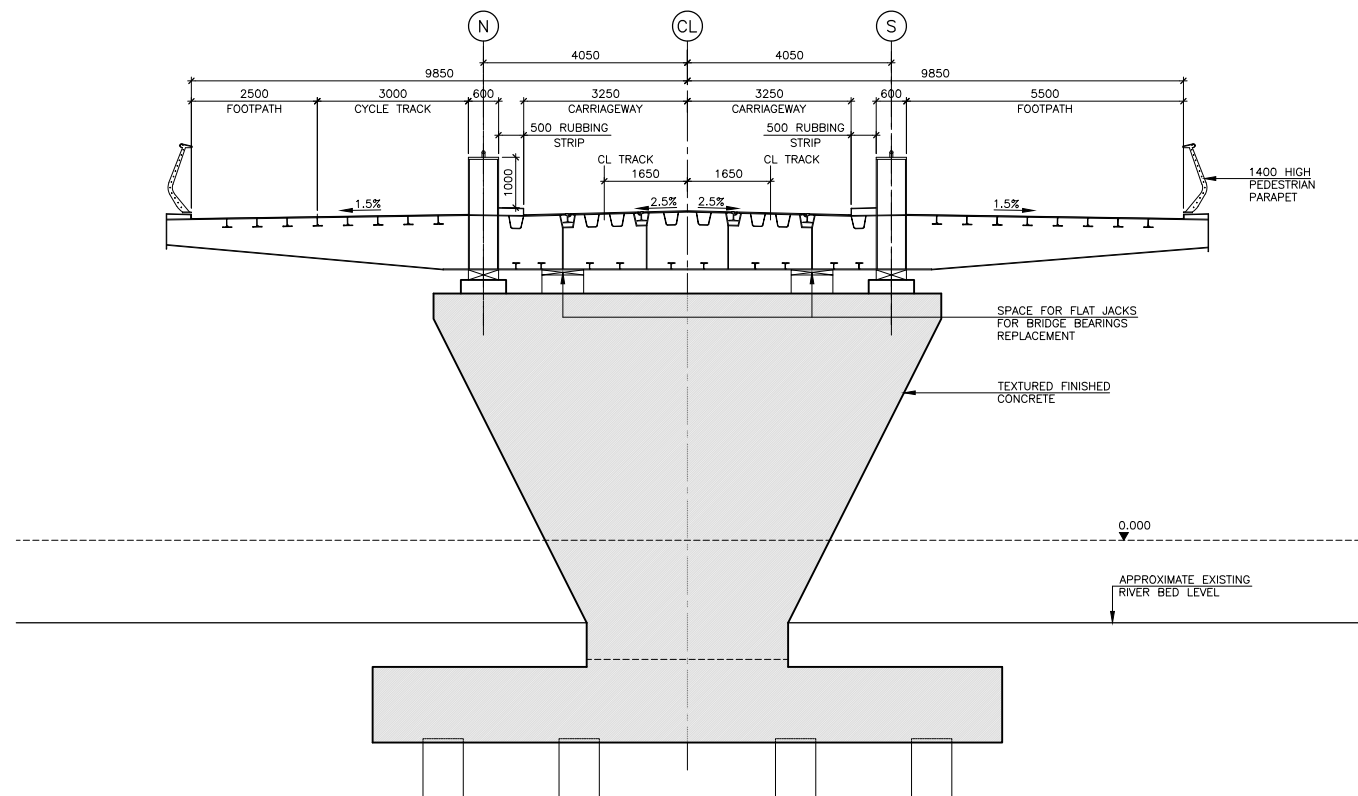

SECTION D
SCALE 1:75
210202



No.	Revision	Date	By	Chkd	App'd
P01	FOR ACCEPTANCE	22.09.20	DQ	JK	TD
P02	ISSUED FOR REVIEW	26.01.21	OB	JK	TD



Arena House, Arena Road, Sandyford, Dublin 18, Ireland
t +353 (0) 1 294 0800
f +353 (0) 1 294 0820
www.rod.ie

Drawn	Designed	Checked	Approved	Suitability Code - Description
PE	JK	JK	TD	S3 - For Acceptance

Project Stage	PRELIMINARY DESIGN				
Project Title	DODDER PUBLIC TRANSPORTATION OPENING BRIDGE				
Drawing Title	DODDER BRIDGE GENERAL ARRANGEMENT - SHEET 3				
Drawing Number	Project	Originator	Volume	Location	Type Role Number
	DPTB	ROD	SBR	DOB	DR - CB - 210204
Scale (A1)	AS SHOWN	Date:	Sept 2020	Job No:	17.143
				Rev:	P02

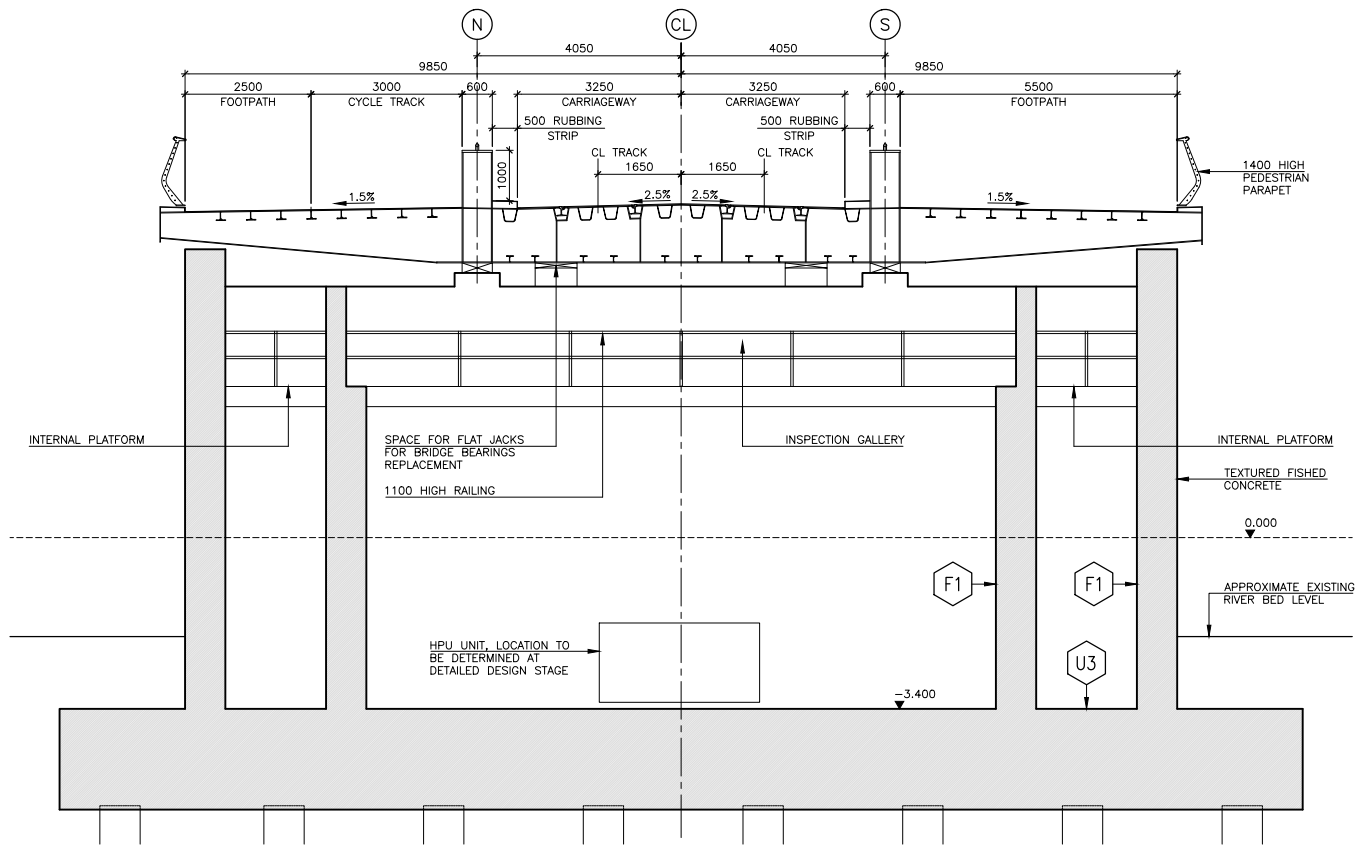

SECTION F
SCALE 1:75
210202

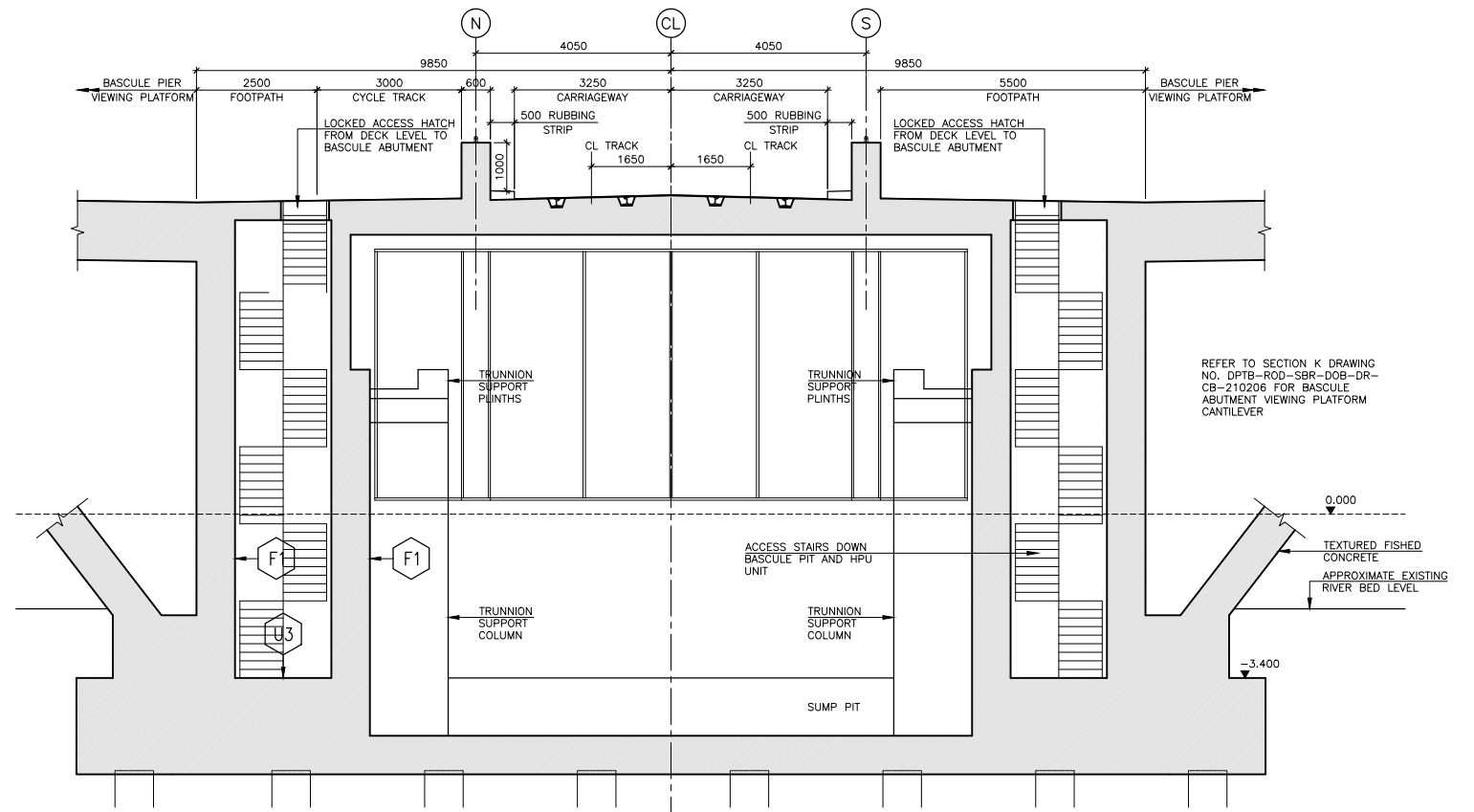

SECTION G
SCALE 1:75
210202

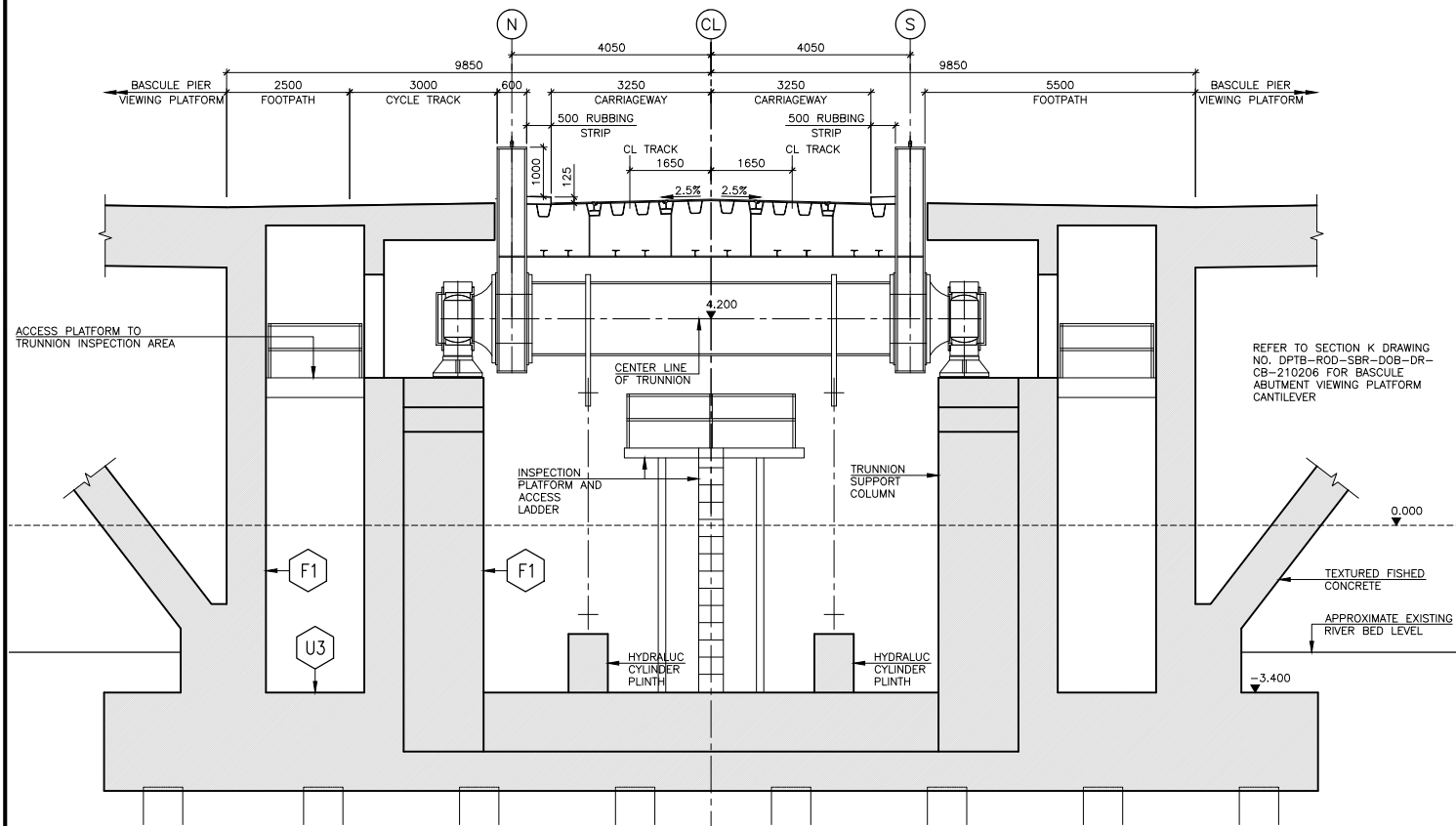

SECTION H
SCALE 1:75
210202

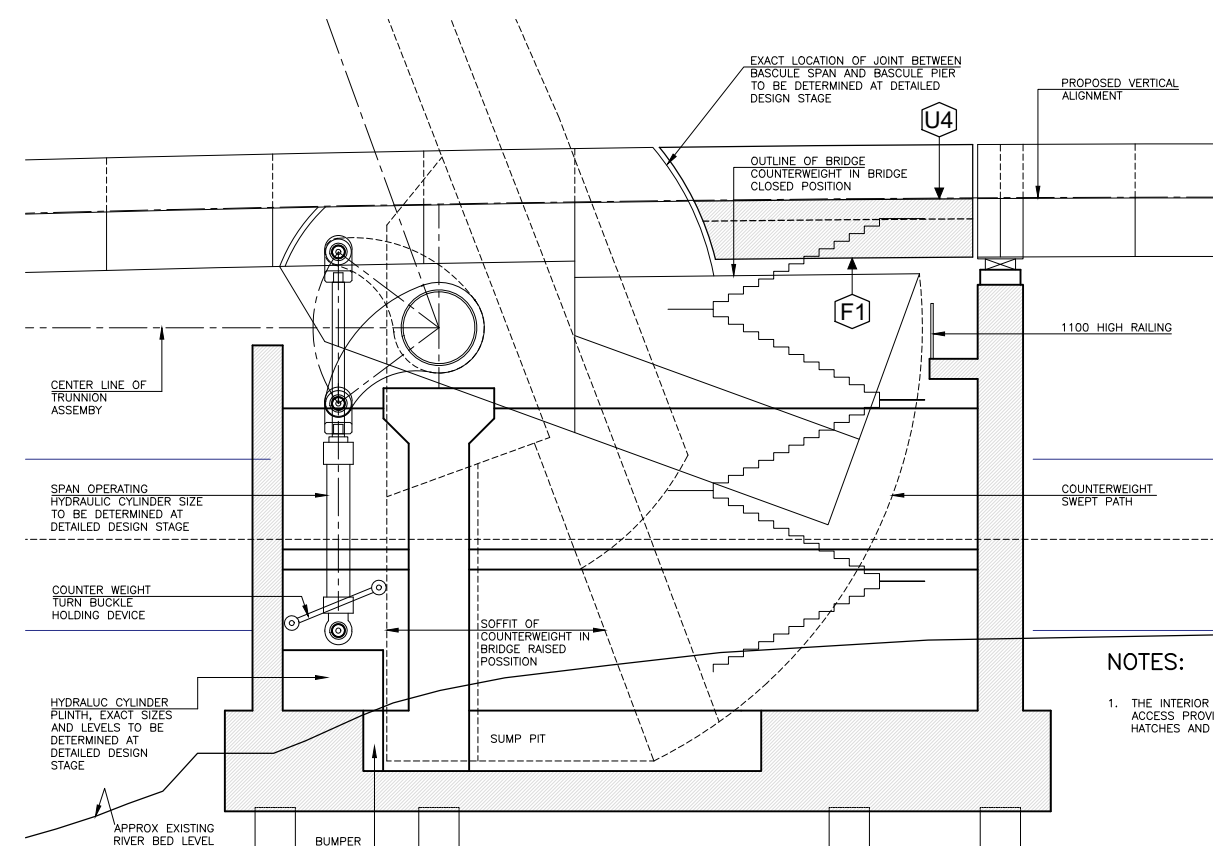

SECTION I
SCALE 1:75
210202

NOTES:
1. THE INTERIOR OF THE BASCULE CHAMBER WILL INCLUDE ACCESS PROVISION INCLUDING ACCESS STAIRS, STEPS, HATCHES AND EDGE PROTECTION



No.	Revision	Date	By	Chkd	App'd
P01	FOR ACCEPTANCE	22.09.20	DQ	JK	TD
P02	ISSUED FOR REVIEW	26.01.21	OB	JK	TD



Arena House, Arena Road, Sandyford, Dublin 18, Ireland
t +353 (0) 1 294 0800
f +353 (0) 1 294 0820
www.rod.ie

Drawn	Designed	Checked	Approved	Suitability Code - Description
PE	JK	JK	TD	S3 - For Acceptance

Project Stage						
PRELIMINARY DESIGN						
Project Title						
DODDER PUBLIC TRANSPORTATION OPENING BRIDGE						
Drawing Title						
DODDER BRIDGE GENERAL ARRANGEMENT - SHEET 4						
Project	Originator	Volume	Location	Type	Role	Number
DPTB	ROD	SBR	DOB	DR	CB	210205
Scale (A1)	Date	Job No.	Rev.			
AS SHOWN	Sept2020	17.143	P02			

NOTES:

1. FOR DETAILS OF PUBLIC REALM REFER TO ARCHITECTURAL LANDSCAPING DRAWINGS.

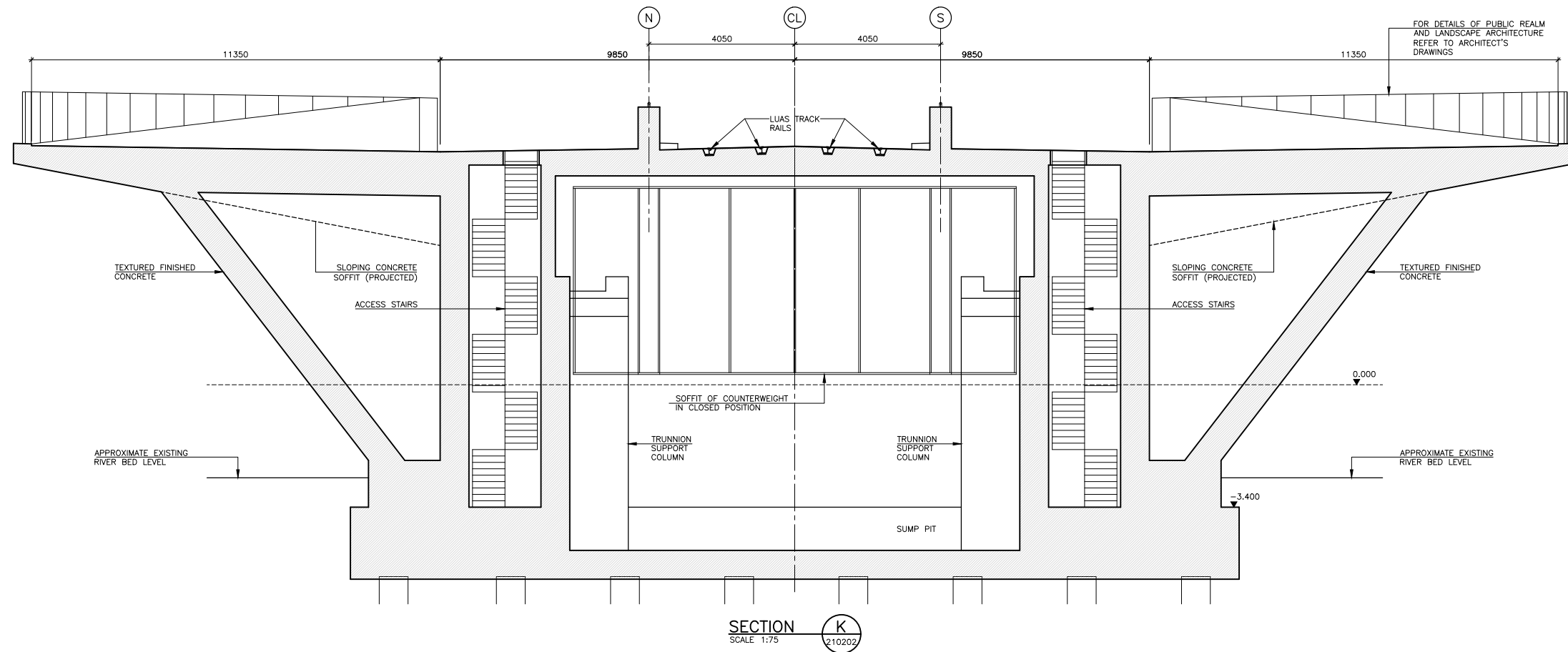

Comhairle Cathrach
Bhaile Átha Cliath
Dublin City Council

No.	Revision	Date	By	Chk'd	App'd
P01	FOR ACCEPTANCE	22.09.20	DQ	JK	TD
P02	ISSUED FOR REVIEW	26.01.21	OB	JK	TD



Consulting Engineers
Civil - Structural - Transportation - Environmental

Arena House, Arena Road, Sandyford, Dublin 18, Ireland
t +353 (0) 1 294 0800
f +353 (0) 1 294 0820
www.rod.ie

Drawn	Designed	Checked	Approved	Suitability Code - Description
PE	JK	JK	TD	S3 - For Acceptance

Project Stage						
DODDER PUBLIC TRANSPORTATION OPENING BRIDGE						
DODDER BRIDGE GENERAL ARRANGEMENT - SHEET 5						
Project	Originator	Volume	Location	Type	Role	Number
DPTB	ROD	SBR	DOB	DR	CB	210206
Scale (A1)	Date	Job No.	Rev.			
AS SHOWN	Sept 2020	17.143	P02			

- NOTES:**
1. ALL DIMENSIONS IN MILLIMETERS, UNLESS OTHERWISE NOTED.
 2. ALL LEVELS ARE IN METRES TO ORDNANCE DATUM MALIN HEAD.
 3. ALL CO-ORDINATES ARE IN METRES TO IRISH TRANSVERSE MERCATOR (ITM).
 4. FINAL DEPTH AND ARRANGEMENT OF PILES SUBJECT TO DETAILED DESIGN.
 5. FOR DETAILS OF PROPOSED PUBLIC REALM AND ST. PATRICK'S ROWING CLUB / DCC BUILDING REFER TO THE LANDSCAPE ARCHITECTURE AND BUILDING DRAWINGS.

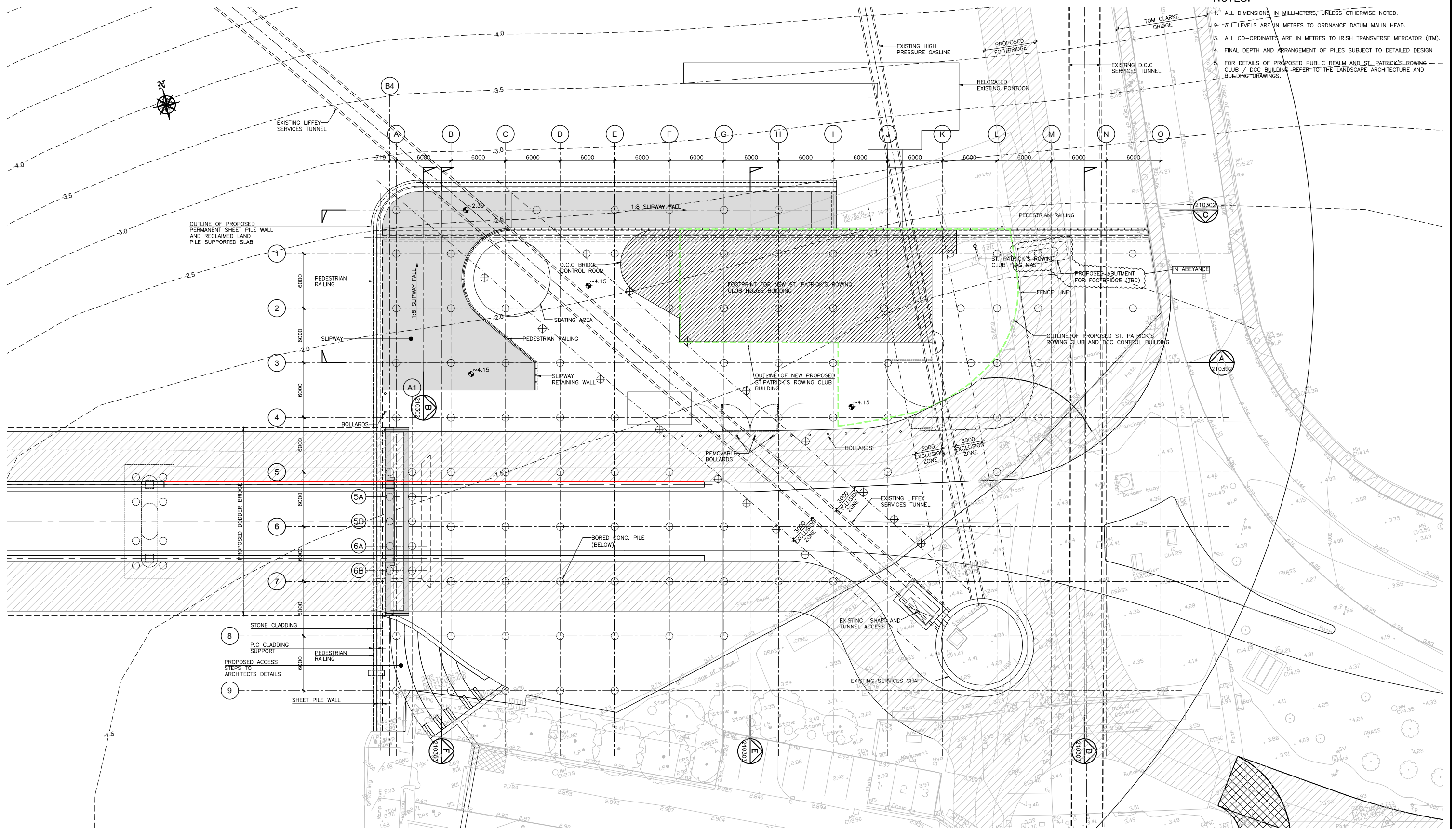

PILE AND RECLAIMED LAND LAYOUT
 SCALE 1:200 A1
 SCALE 1:400 A3



No.	Revision	Date	By	Chkd	App'd
P01	FOR ACCEPTANCE	22.09.20	DQ	JK	TD
P02	ISSUED FOR REVIEW	26.01.21	OB	JK	TD



Arena House, Arena Road, Sandycove, Dublin 18, Ireland
 t +353 (0) 1 294 0800
 f +353 (0) 1 294 0820
 www.rod.ie

Civil - Structural - Transportation - Environmental

Drawn	Designed	Checked	Approved	Suitability Code - Description
OB	JK	JK	TD	S3 - For Acceptance

Project Stage	PRELIMINARY DESIGN				
Project Title	DODDER PUBLIC TRANSPORTATION OPENING BRIDGE				
Drawing Title	RECLAIMED LAND GENERAL ARRANGEMENT - SHEET 1				
Drawing Number	Project	Originator	Volume	Location	Type Role Number
	DPTB	ROD	SBR	LRN	DRG - CB - 210301
Scale (A1)	AS SHOWN	Date:	Nov' 2019	Job No:	17.143
				Rev:	P02

NOTES:

1. ALL DIMENSIONS IN MILLIMETERS, UNLESS OTHERWISE NOTED.
2. ALL LEVELS ARE IN METRES TO ORDNANCE DATUM MALIN HEAD.
3. ALL CO-ORDINATES ARE IN METRES TO IRISH TRANSVERSE MERCATOR (ITM).
4. FINAL DEPTH AND ARRANGEMENT OF PILES SUBJECT TO DETAILED DESIGN
5. FOR DETAILS OF PROPOSED PUBLIC REALM AND ST. PATRICK'S ROWING CLUB / DCC BUILDING REFER TO THE LANDSCAPE ARCHITECTURE AND BUILDING DRAWINGS.
6. ALL BURIED SURFACE SHALL BE WATERPROOFED IN ACCORDANCE WITH THE SPECIFICATION FOR ROAD WORKS
7. CONTRACTOR TO CONFIRM LOCATION OF ANY SERVICES PRIOR TO INSTALLATION OF ANY PRELIMINARY OR PERMANENT PILES. REFER TO DRAWING No. 210121

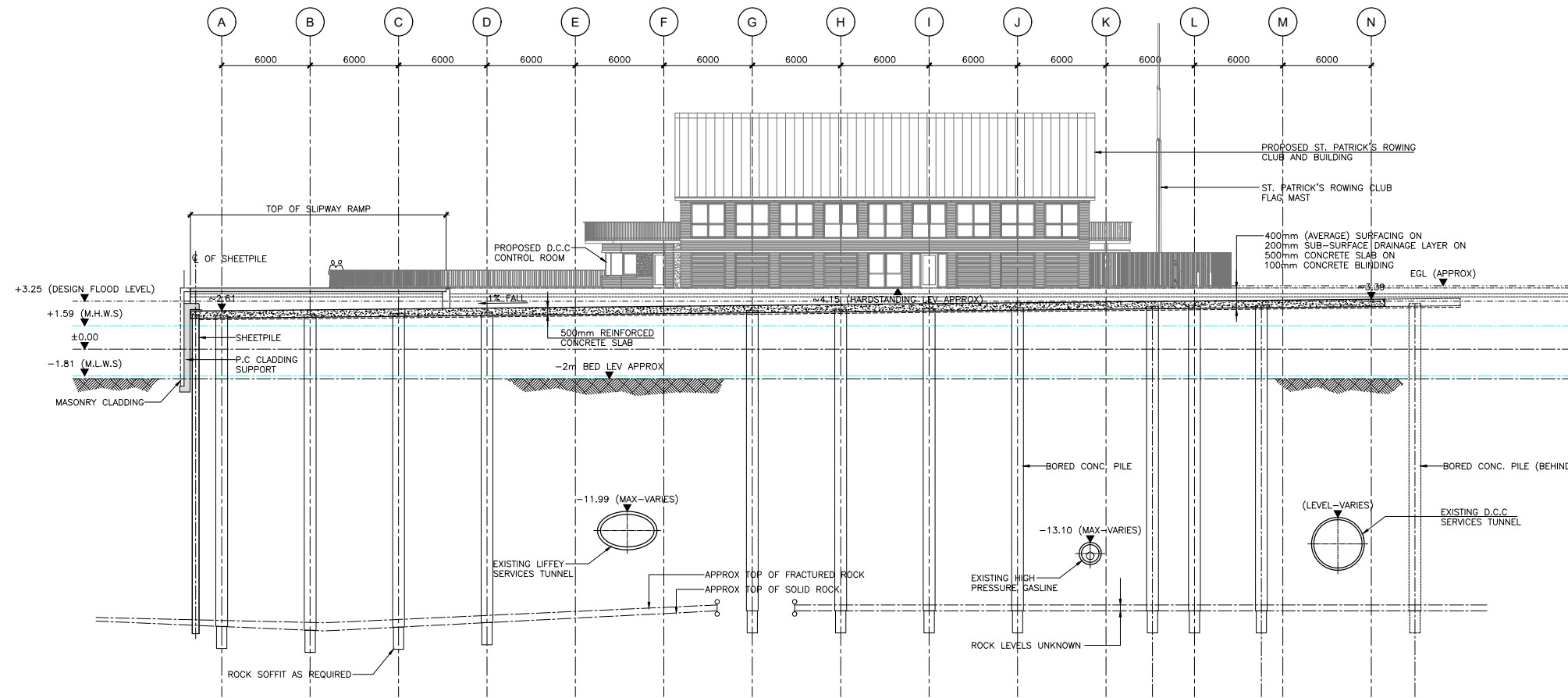

SECTION A
A1 SCALE 1:200
A3 SCALE 1:400

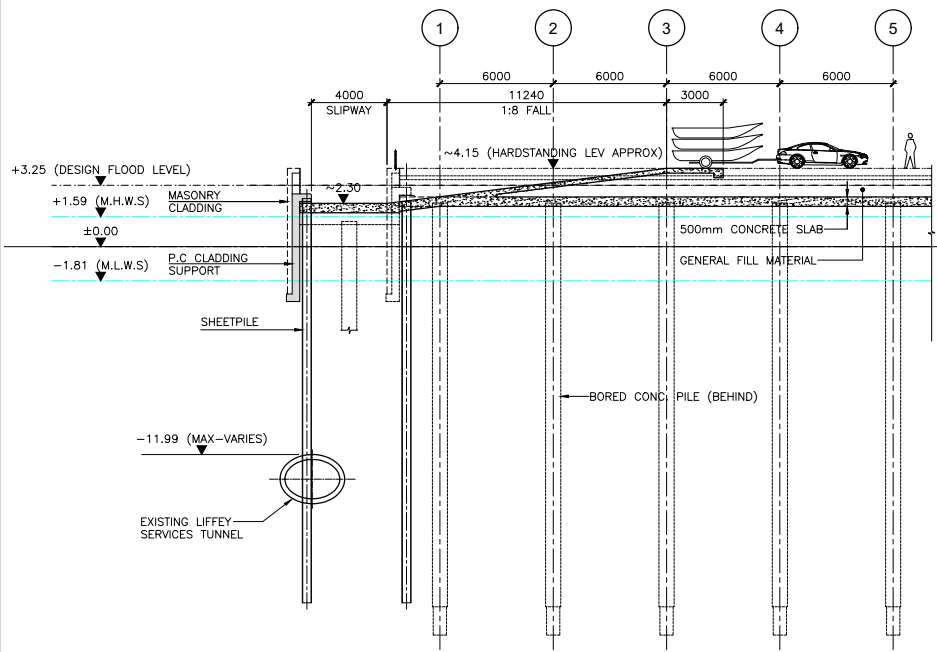

SECTION B
A1 SCALE 1:200
A3 SCALE 1:400

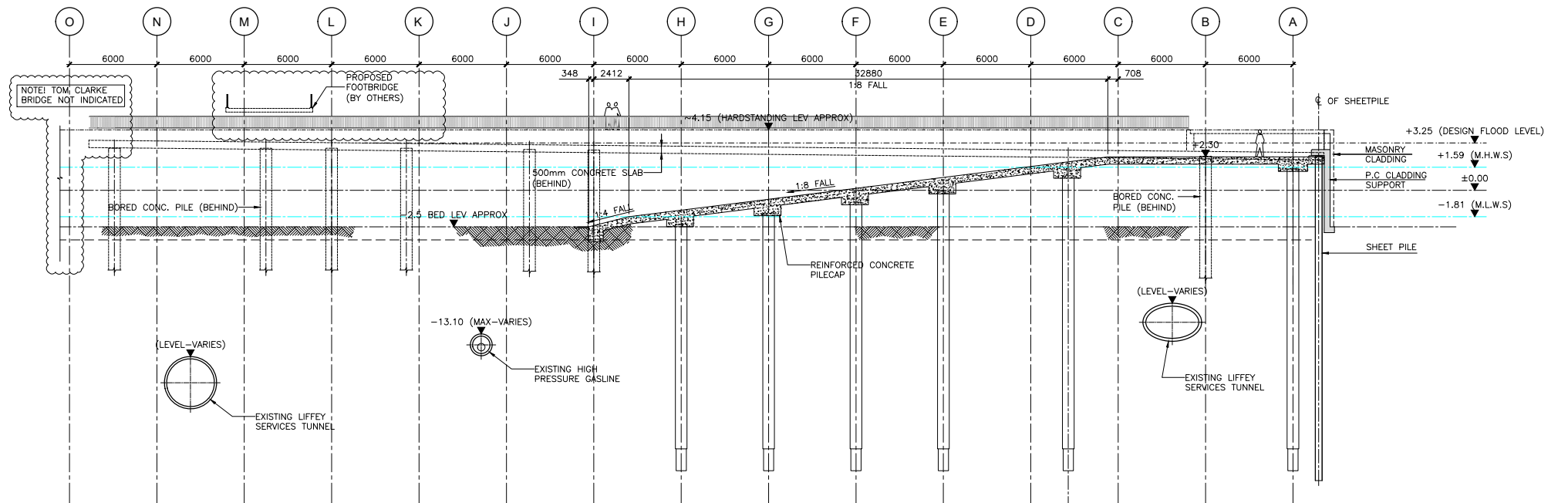

SECTION C
A1 SCALE 1:200
A3 SCALE 1:400



No.	Revision	Date	By	Chkd	App'd
P01	FOR ACCEPTANCE	22.09.20	DO	JK	TD
P02	ISSUED FOR REVIEW	26.01.21	OB	JK	TD



Arena House, Arena Road, Sandyford, Dublin 18, Ireland
t +353 (0) 1 294 0800
f +353 (0) 1 294 0820
www.rod.ie

Drawn	Designed	Checked	Approved	Suitability Code - Description
OB	JK	JK	TD	S3 - For Acceptance

Project Stage	PRELIMINARY DESIGN				
Project Title	DODDER PUBLIC TRANSPORTATION OPENING BRIDGE				
Drawing Title	RECLAIMED LAND GENERAL ARRANGEMENT - SHEET 2				
Drawing Number	Project	Originator	Volume	Location	Type Role Number
	DPTB	ROD	SBR	LRN	DRG - CB - 210302
Scale (A1)	AS SHOWN	Date:	Nov' 2019	Job No:	17.143
				Rev:	P02

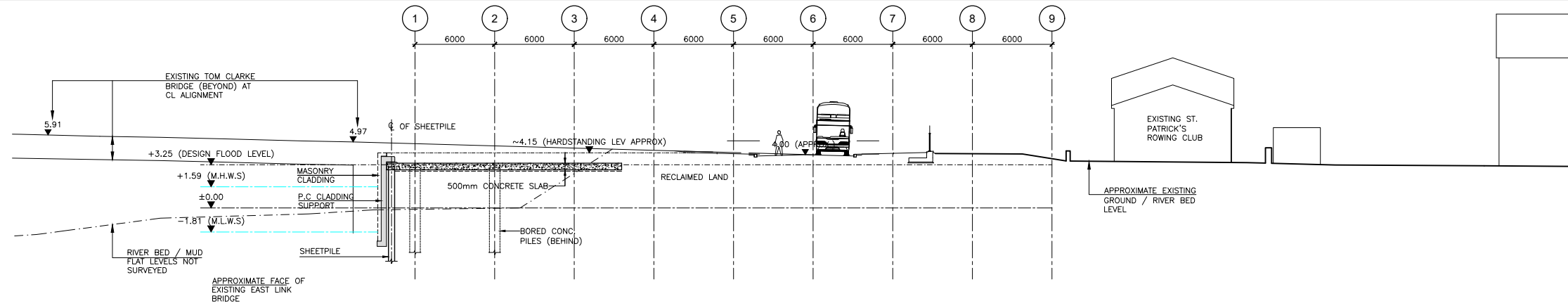

NOTES:

1. ALL DIMENSIONS IN MILLIMETERS, UNLESS OTHERWISE NOTED.
2. ALL LEVELS ARE IN METRES TO ORDNANCE DATUM MALIN HEAD.
3. ALL CO-ORDINATES ARE IN METRES TO IRISH TRANSVERSE MERCATOR (ITM).
4. FINAL DEPTH AND ARRANGEMENT OF PILES SUBJECT TO DETAILED DESIGN
5. FOR DETAILS OF PROPOSED PUBLIC REALM AND ST. PATRICK'S ROWING CLUB / DCC BUILDING REFER TO THE LANDSCAPE ARCHITECTURE AND BUILDING DRAWINGS.
6. ALL BURIED SURFACE SHALL BE WATERPROOFED IN ACCORDANCE WITH THE SPECIFICATION FOR ROAD WORKS
7. CONTRACTOR TO CONFIRM LOCATION OF ANY SERVICES PRIOR TO INSTALLATION OF ANY PRELIMINARY OR PERMANENT PILES. REFER TO DRAWING No. 210121

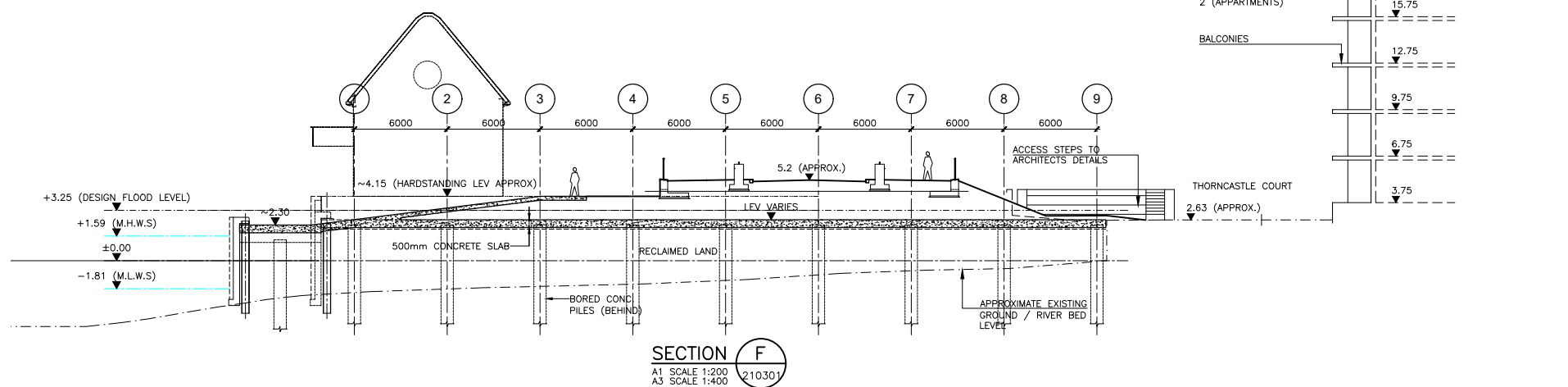
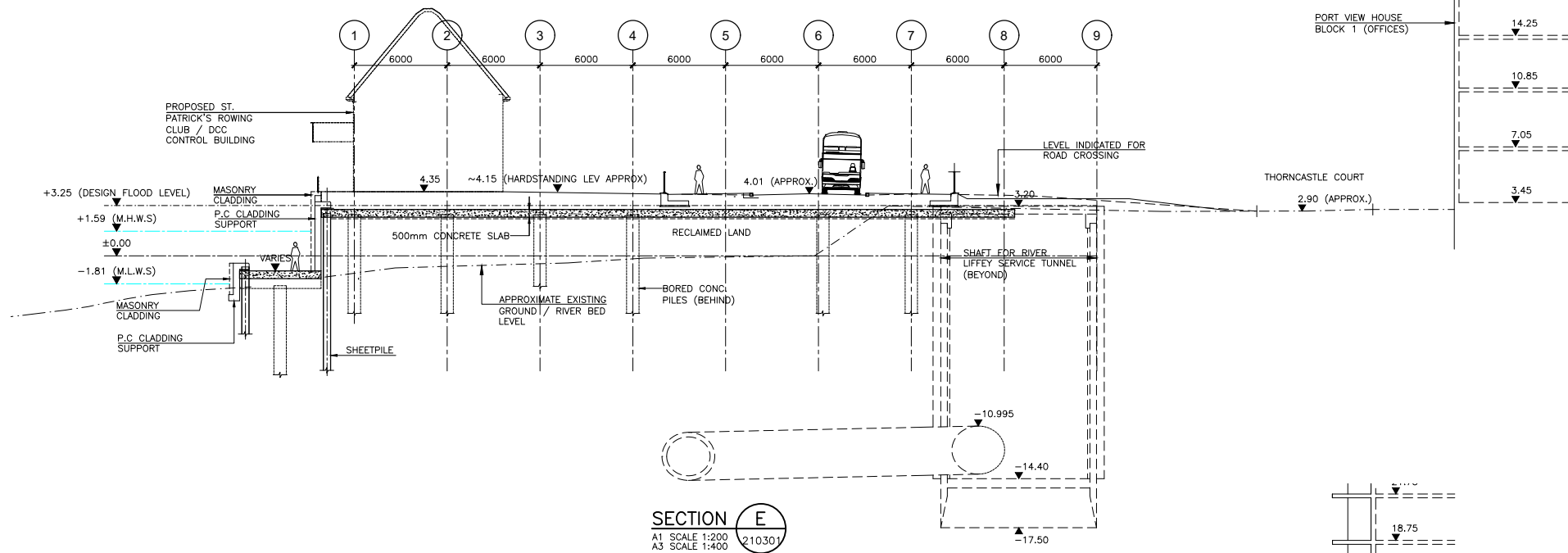
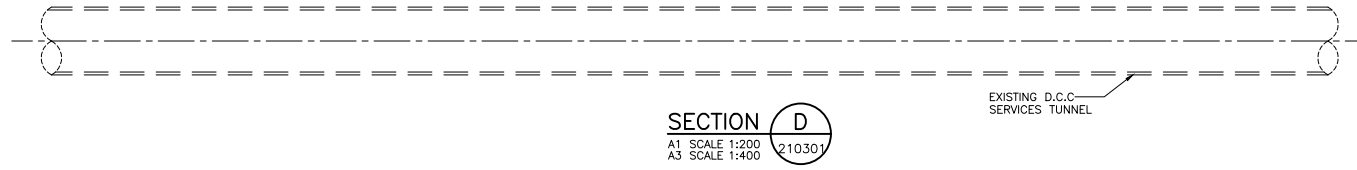

No.	Revision	Date	By	Chkd	App'd
P01	FOR ACCEPTANCE	22.09.20	DO	JK	TD
P02	ISSUED FOR REVIEW	26.01.21	OB	JK	TD



Arena House, Arena Road, Sandyford, Dublin 18, Ireland
 t +353 (0) 1 294 0800
 f +353 (0) 1 294 0820
 www.rod.ie

Drawn	Designed	Checked	Approved	Suitability Code - Description
OB	JK	JK	TD	S3 - For Acceptance

Project Stage	PRELIMINARY DESIGN				
Project Title	DODDER PUBLIC TRANSPORTATION OPENING BRIDGE				
Drawing Title	RECLAIMED LAND GENERAL ARRANGEMENT - SHEET 3				
Drawing Number	Project	Originator	Volume	Location	Type Role Number
	DPTB	ROD	SBR	LRN	DRG - CB - 210303
Scale (A1)	AS SHOWN	Date:	Nov' 2019	Job No:	17.143
				Rev:	P02

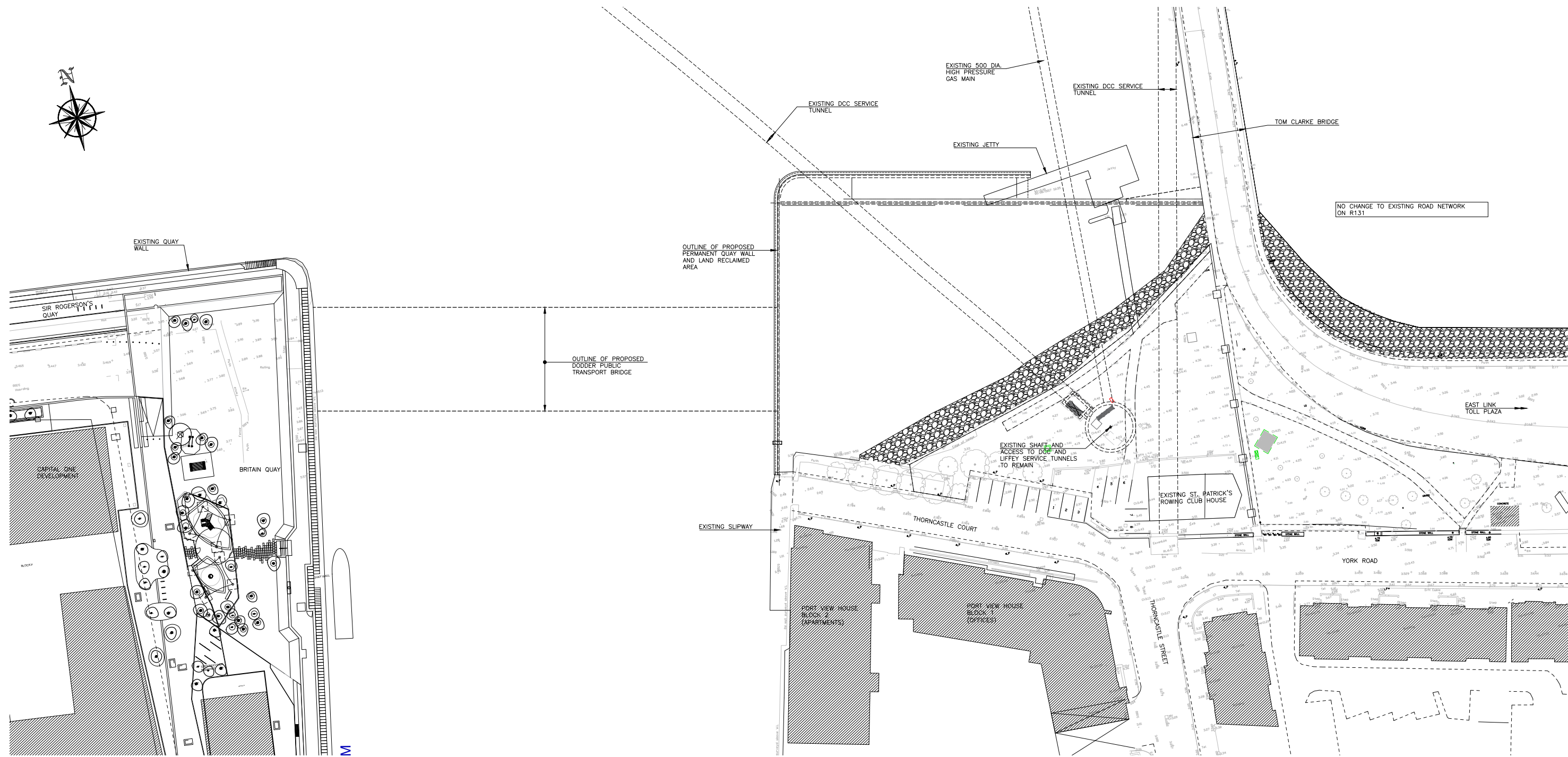

GENERAL CONSTRUCTION SEQUENCE – PLAN – STAGE 0
(EXISTING CONDITION)
SCALE 1:400

- LEGEND:**
- EXISTING STONE RUBBLE RIVER FRONT
 - COMPLETED ST. PATRICK'S ROWING CLUB STRUCTURES AND ACCESS ROAD
 - CURRENT CONSTRUCTION STAGE GENERAL WORKS AREA
 - ACCESS ROAD, TRACK AND BUILDING TO BE MAINTAINED DURING CONSTRUCTION
 - EXISTING BUILDING TO BE DEMOLISHED
 - FINISHED ROAD SURFACE
 - CYCLE TRACK SURFACE
 - FINISHED FOOTPATH

<p>Comhairle Cathrach Bhaile Átha Cliath Dublin City Council</p>	<p>Michel Virlogeux Consultant SARL 24, RUE DE LA DIVISION LECLERC 78830 BONNELLES Mobile : 06 14 24 35 90 Fax : 01 30 88 43 44</p>	<p>SEÁN HARRINGTON ARCHITECTS</p>	<table border="1" style="width: 100%; border-collapse: collapse;"> <thead> <tr> <th>No.</th> <th>Revision</th> <th>Date</th> <th>By</th> <th>Chk'd</th> <th>App'd</th> </tr> </thead> <tbody> <tr> <td>PO1</td> <td>FOR ACCEPTANCE</td> <td>22.09.20</td> <td>DQ</td> <td>JK</td> <td>TD</td> </tr> <tr> <td>PO2</td> <td>ISSUED FOR REVIEW</td> <td>26.01.21</td> <td>OB</td> <td>JK</td> <td>TD</td> </tr> </tbody> </table>	No.	Revision	Date	By	Chk'd	App'd	PO1	FOR ACCEPTANCE	22.09.20	DQ	JK	TD	PO2	ISSUED FOR REVIEW	26.01.21	OB	JK	TD	<p>FROD ROUGHAN & O'DONOVAN Consulting Engineers Civil - Structural - Transportation - Environmental</p>	<p>Arena House, Arena Road, Sandycove, Dublin 18, Ireland t +353 (0) 1 294 0800 f +353 (0) 1 294 0820 www.rod.ie</p>	<p>Project Title DODDER PUBLIC TRANSPORTATION OPENING BRIDGE</p> <p>Drawing Title SCHEME CONSTRUCTION SEQUENCE SHEET 1</p>	
			No.	Revision	Date	By	Chk'd	App'd																	
PO1	FOR ACCEPTANCE	22.09.20	DQ	JK	TD																				
PO2	ISSUED FOR REVIEW	26.01.21	OB	JK	TD																				
<table border="1" style="width: 100%; border-collapse: collapse;"> <thead> <tr> <th>Drawn</th> <th>Designed</th> <th>Checked</th> <th>Approved</th> <th>Suitability Code - Description</th> </tr> </thead> <tbody> <tr> <td>PE</td> <td>CS</td> <td>JK</td> <td>TD</td> <td>S3 - For Acceptance</td> </tr> </tbody> </table>	Drawn	Designed	Checked	Approved	Suitability Code - Description	PE	CS	JK	TD	S3 - For Acceptance	<table border="1" style="width: 100%; border-collapse: collapse;"> <thead> <tr> <th>Project</th> <th>Originator</th> <th>Volume</th> <th>Location</th> <th>Type</th> <th>Role</th> <th>Number</th> </tr> </thead> <tbody> <tr> <td>DPTB</td> <td>ROD</td> <td>SBR</td> <td>SWE</td> <td>DRG</td> <td>CV</td> <td>210401</td> </tr> </tbody> </table>	Project	Originator	Volume	Location	Type	Role	Number	DPTB	ROD	SBR	SWE	DRG	CV	210401
Drawn	Designed	Checked	Approved	Suitability Code - Description																					
PE	CS	JK	TD	S3 - For Acceptance																					
Project	Originator	Volume	Location	Type	Role	Number																			
DPTB	ROD	SBR	SWE	DRG	CV	210401																			

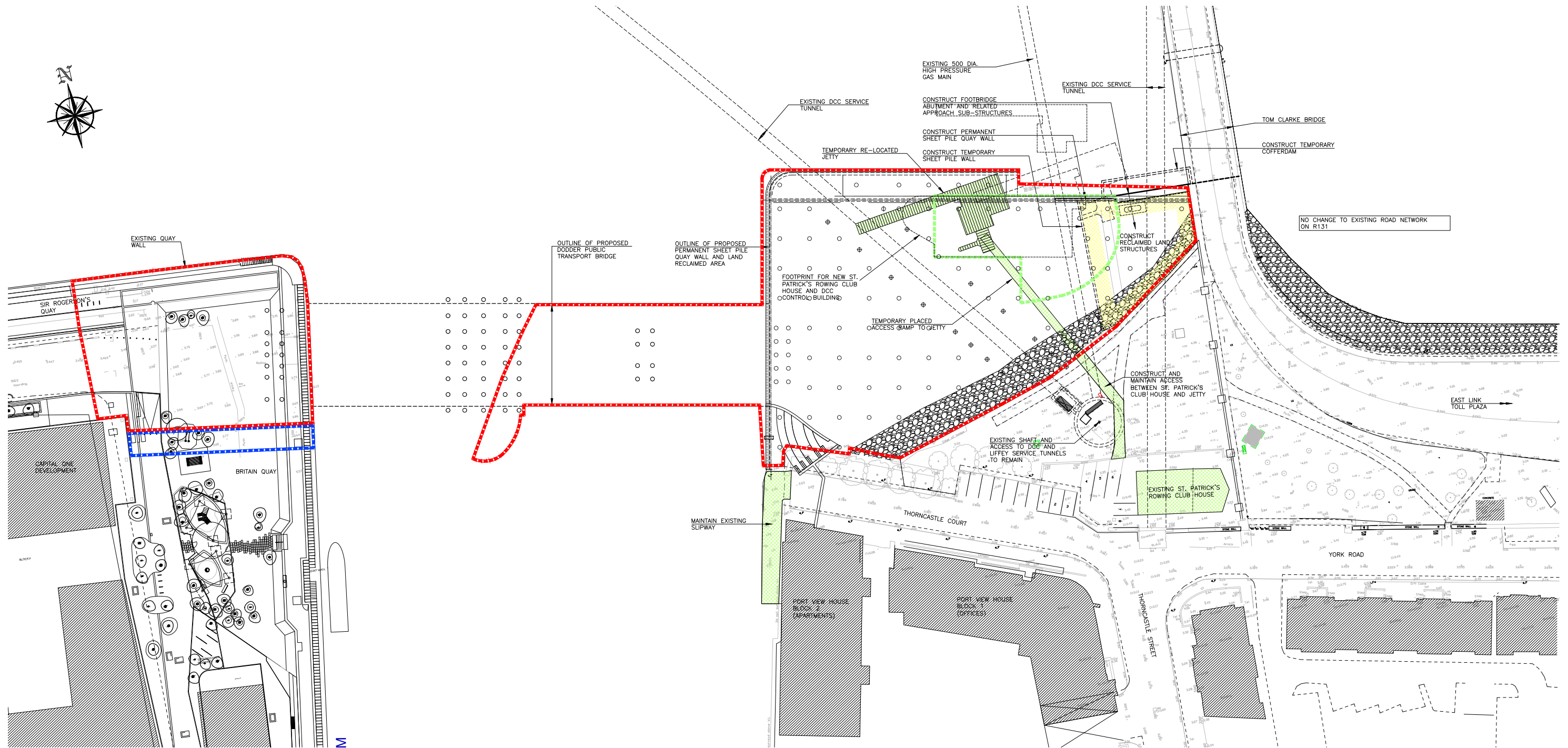

LEGEND:

- PERMANENT LAND ACQUISITION
- TEMPORARY LAND ACQUISITION (SITE COMPOUND)
- CURRENT CONSTRUCTION STAGE GENERAL WORKS AREA
- ACCESS ROAD, TRACK AND BUILDING TO BE MAINTAINED DURING CONSTRUCTION
- EXISTING BUILDING TO BE DEMOLISHED
- EXISTING STONE RUBBLE RIVER FRONT
- COMPLETED ST. PATRICK'S ROWING CLUB STRUCTURES AND ACCESS ROAD
- FINISHED ROAD SURFACE
- CYCLE TRACK SURFACE
- FINISHED FOOTPATH

GENERAL CONSTRUCTION SEQUENCE – PLAN – STAGE 1
SCALE 1:400

CONSTRUCTION SEQUENCE:

1. RELOCATE JETTY AND CONSTRUCT ACCESS RAMP.
2. CONSTRUCT FOOTPATH TO JETTY ACCESS RAMP.
3. CONSTRUCT PERMANENT AND TEMPORARY SHEET PILE WALLS.
4. CONSTRUCT RECLAIMED LAND STRUCTURES.
5. CONSTRUCT POINT PEDESTRIAN AND CYCLE FOOTBRIDGE ABUTMENT AND RELATED BRIDGE APPROACH SUB-STRUCTURES.

NOTES:

1. LAYOUT, LIMITS AND LOCATION OF SHOWN PROPOSED ROADS AND STRUCTURES ARE BASED ON A PRELIMINARY LAYOUT AND ARE THEREFORE SUBJECT TO ADJUSTMENTS. ACCESS BETWEEN ST. PATRICK'S ROWING CLUB HOUSE AND JETTY ARE TO BE MAINTAINED DURING THE CONSTRUCTION PERIOD.
2. THE CONTRACTOR SHALL SUBMIT METHOD STATEMENTS, CALCULATIONS AND DRAWINGS TO THE ENGINEER FOR APPROVAL IN ORDER TO DEMONSTRATE THAT THE CONSTRUCTION METHOD WILL HAVE NO ADVERSE EFFECT ON THE PERMANENT WORKS



Michel Virlogeux Consultant SARL
24, RUE DE LA DIVISION LECLERC
78830 BONNELLES
Mobile : 06 14 24 35 90
Fax : 01 30 88 43 44

SEÁN HARRINGTON ARCHITECTS

No.	Revision	Date	By	Chk'd	App'd
PO1	FOR ACCEPTANCE	22.09.20	DQ	JK	TD
PO2	ISSUED FOR REVIEW	26.01.21	OB	JK	TD







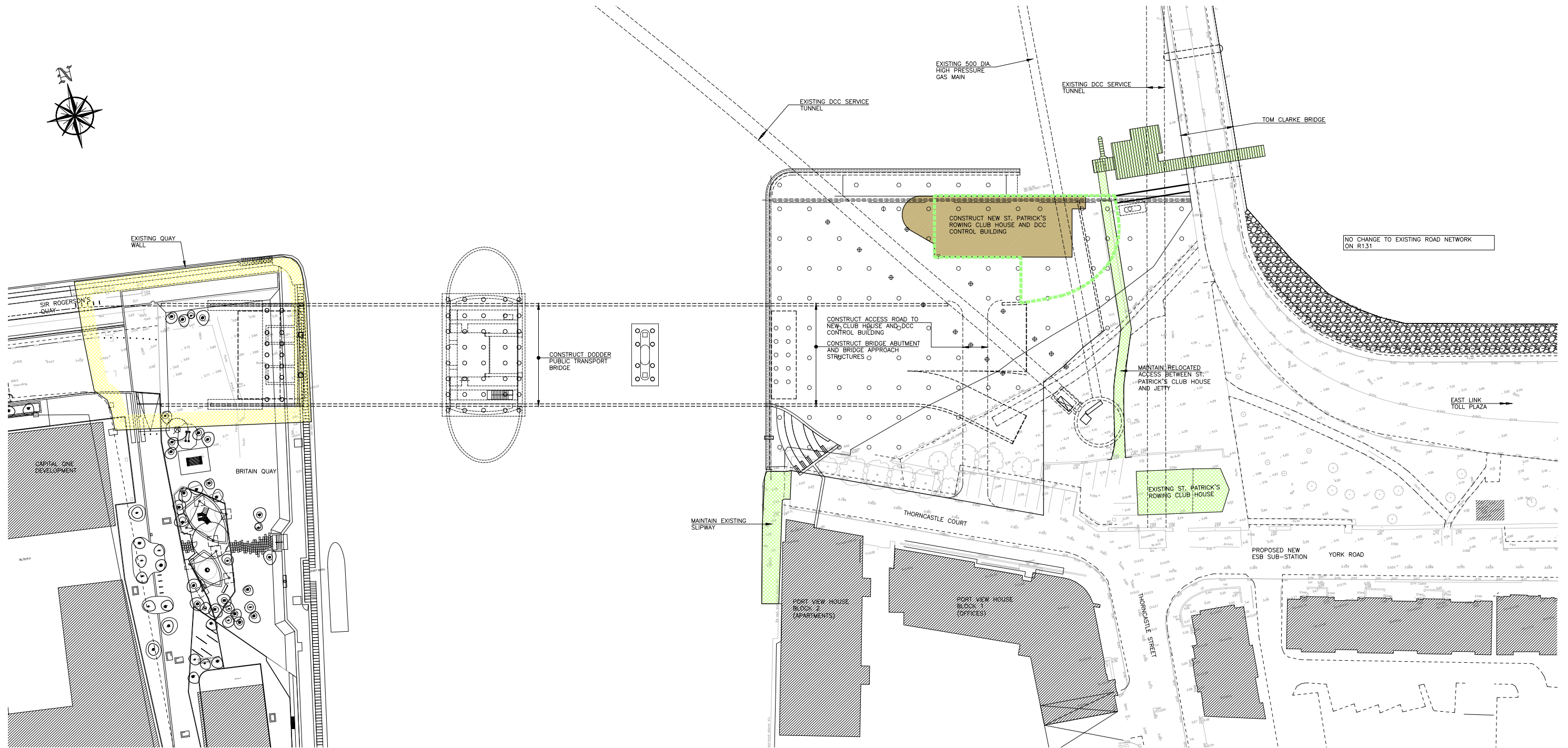

Arena House, Arena Road, Sandycove, Dublin 18, Ireland
t +353 (0) 1 294 0800
f +353 (0) 1 294 0820
www.rod.ie

Project Title		DODDER PUBLIC TRANSPORTATION OPENING BRIDGE					
Drawing Title		SCHEME CONSTRUCTION SEQUENCE SHEET 2					
Project	Originator	Volume	Location	Type	Role	Number	
DPTB	ROD	SBR	SWE	DRG	CV	210402	
Scale (A1)	AS SHOWN	Date:	Sept. 2020	Job No:	17143	Rev:	P02

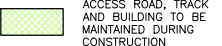

LEGEND:

-  EXISTING STONE RUBBLE RIVER FRONT
-  COMPLETED ST. PATRICK'S ROWING CLUB STRUCTURES AND ACCESS ROAD
-  CURRENT CONSTRUCTION STAGE GENERAL WORKS AREA
-  ACCESS ROAD, TRACK AND BUILDING TO BE MAINTAINED DURING CONSTRUCTION
-  EXISTING BUILDING TO BE DEMOLISHED
-  FINISHED ROAD SURFACE
-  CYCLE TRACK SURFACE
-  FINISHED FOOTPATH

GENERAL CONSTRUCTION SEQUENCE – PLAN – STAGE 3

SCALE 1:400

CONSTRUCTION SEQUENCE:

1. CONSTRUCT DODDER BRIDGE APPROACH STRUCTURES.
2. CONSTRUCT ST. PATRICK'S ROWING CLUB HOUSE AND DCC CONTROL BUILDING. CONSTRUCT NEW SLIPWAY.
3. CONSTRUCT ACCESS ROAD BETWEEN NEW CLUB HOUSE AND THORNCASTLE COURT.

NOTES:

1. LAYOUT, LIMITS AND LOCATION OF SHOWN PROPOSED ROADS AND STRUCTURES ARE BASED ON A PRELIMINARY LAYOUT AND ARE THEREFORE SUBJECT TO ADJUSTMENTS. ACCESS BETWEEN ST. PATRICK'S ROWING CLUB HOUSE AND JETTY ARE TO BE MAINTAINED DURING THE CONSTRUCTION PERIOD.
2. SIGNIFICANT DISRUPTION TO THORNCASTLE COURT WILL BE REQUIRED THROUGHOUT.
3. THE CONTRACTOR SHALL SUBMIT METHOD STATEMENTS, CALCULATIONS AND DRAWINGS TO THE ENGINEER FOR APPROVAL IN ORDER TO DEMONSTRATE THAT THE CONSTRUCTION METHOD WILL HAVE NO ADVERSE EFFECT ON THE PERMANENT WORKS.



Michel Virlogeux Consultant SARL
24, RUE DE LA DIVISION LECLERC
78830 BONNELLES
Mobile : 06 14 24 35 90
Fax : 01 30 88 43 44



No.	Revision	Date	By	Chk'd	App'd
PO1	FOR ACCEPTANCE	22.09.20	DQ	JK	TD
PO2	ISSUED FOR REVIEW	26.01.21	OB	JK	TD







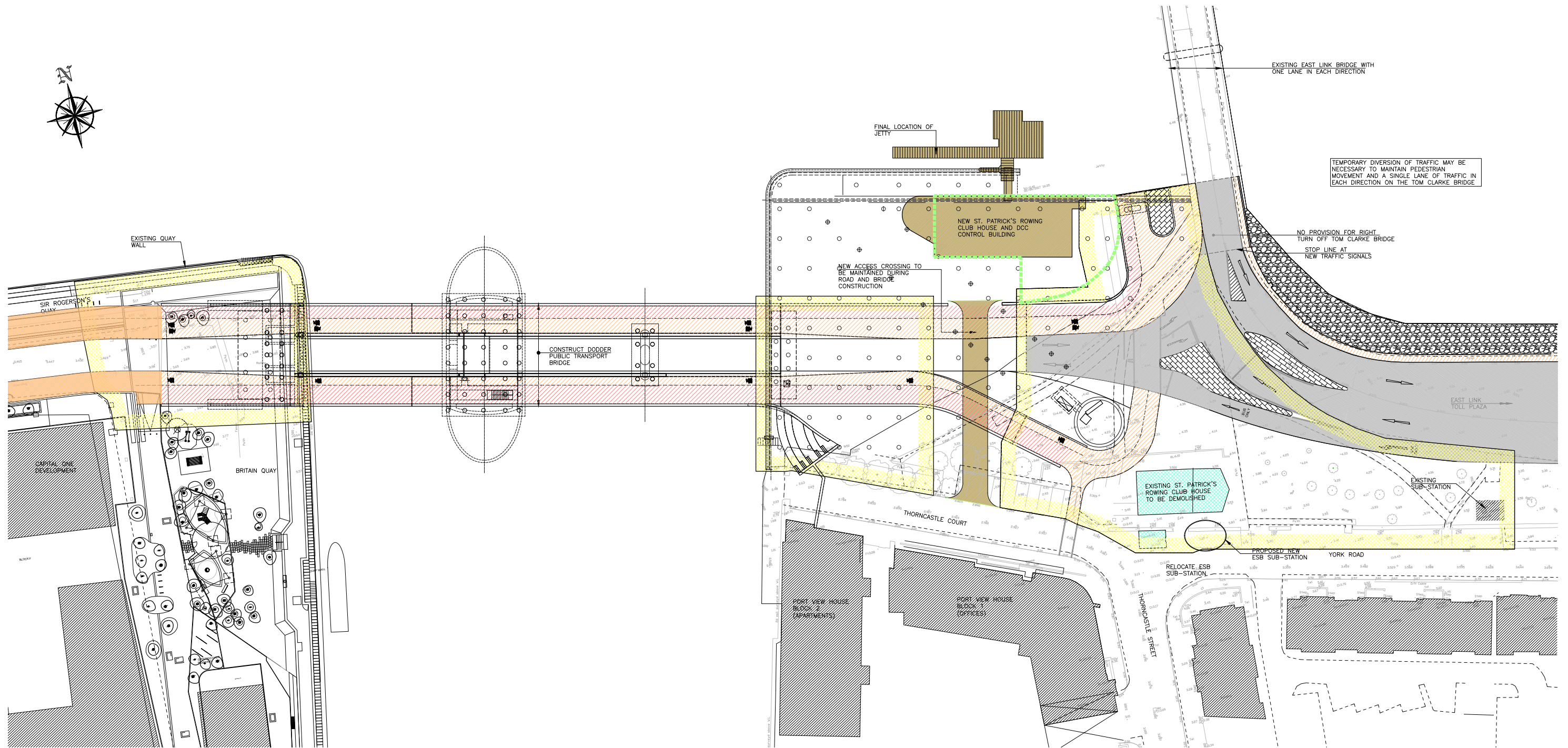

Arena House, Arena Road, Sandycove, Dublin 18, Ireland
t +353 (0) 1 294 0800
f +353 (0) 1 294 0820
www.rod.ie

Drawn	Designed	Checked	Approved	Suitability Code - Description
PE	CS	JK	TD	S3 - For Acceptance

Project Title		DODDER PUBLIC TRANSPORTATION OPENING BRIDGE			
Drawing Title		SCHEME CONSTRUCTION SEQUENCE SHEET 4			
Project Number	Originator	Volume	Location	Type	Role
DPTB	ROD	SBR	SWE	DRG	CV
Drawing Number	210404				
Scale (A1)	AS SHOWN	Date:	Sept. 2020	Job No:	17143
				Rev:	P02

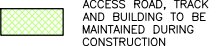

LEGEND:

-  EXISTING STONE RUBBLE RIVER FRONT
-  COMPLETED ST. PATRICK'S ROWING CLUB STRUCTURES AND ACCESS ROAD
-  CURRENT CONSTRUCTION STAGE GENERAL WORKS AREA
-  ACCESS ROAD, TRACK AND BUILDING TO BE MAINTAINED DURING CONSTRUCTION
-  EXISTING BUILDING TO BE DEMOLISHED
-  FINISHED ROAD SURFACE
-  CYCLE TRACK SURFACE
-  FINISHED FOOTPATH

GENERAL CONSTRUCTION SEQUENCE – PLAN – STAGE 4

SCALE 1:400

CONSTRUCTION SEQUENCE:

1. CONSTRUCT DODDER BRIDGE.
2. RELOCATE JETTY TO ITS FINAL POSITION.
3. DEMOLISH EXISTING ST. PATRICK'S ROWING CLUB HOUSE.
4. CONSTRUCT NEW JUNCTION TO EAST LINK OPTION 1.
5. CONSTRUCT NEW ESB SUB-STATION.

NOTES:

1. LAYOUT, LIMITS AND LOCATION OF SHOWN PROPOSED ROADS AND STRUCTURES ARE BASED ON A PRELIMINARY LAYOUT AND ARE THEREFORE SUBJECT TO ADJUSTMENTS. ACCESS BETWEEN ST. PATRICK'S ROWING CLUB HOUSE AND JETTY ARE TO BE MAINTAINED DURING THE CONSTRUCTION PERIOD.
2. SIGNIFICANT DISRUPTION SHOULD BE ANTICIPATED DURING THE CONSTRUCTION OF THE ROAD TIE-INS. THE MAJORITY OF THESE WORKS COULD BE UNDERTAKEN AT NIGHT BUT TEMPORARY DIVERSIONS OF TRAFFIC MAY BE REQUIRED ON THE WEST SIDE OF THE R131 TO ACCOMMODATE THESE WORKS.
3. THE CONTRACTOR SHALL SUBMIT METHOD STATEMENTS, CALCULATIONS AND DRAWINGS TO THE ENGINEER FOR APPROVAL IN ORDER TO DEMONSTRATE THAT THE CONSTRUCTION METHOD WILL HAVE NO ADVERSE EFFECT ON THE PERMANENT WORKS.



Michel Virlogeux Consultant SARL
24, RUE DE LA DIVISION LECLERC
78830 BONNELLES
Mobile : 06 14 24 35 90
Fax : 01 30 88 43 44

SEÁN HARRINGTON ARCHITECTS

No.	Revision	Date	By	Chk'd	App'd
PO1	FOR ACCEPTANCE	22.09.20	DQ	JK	TD
PO2	ISSUED FOR REVIEW	26.01.21	OB	JK	TD







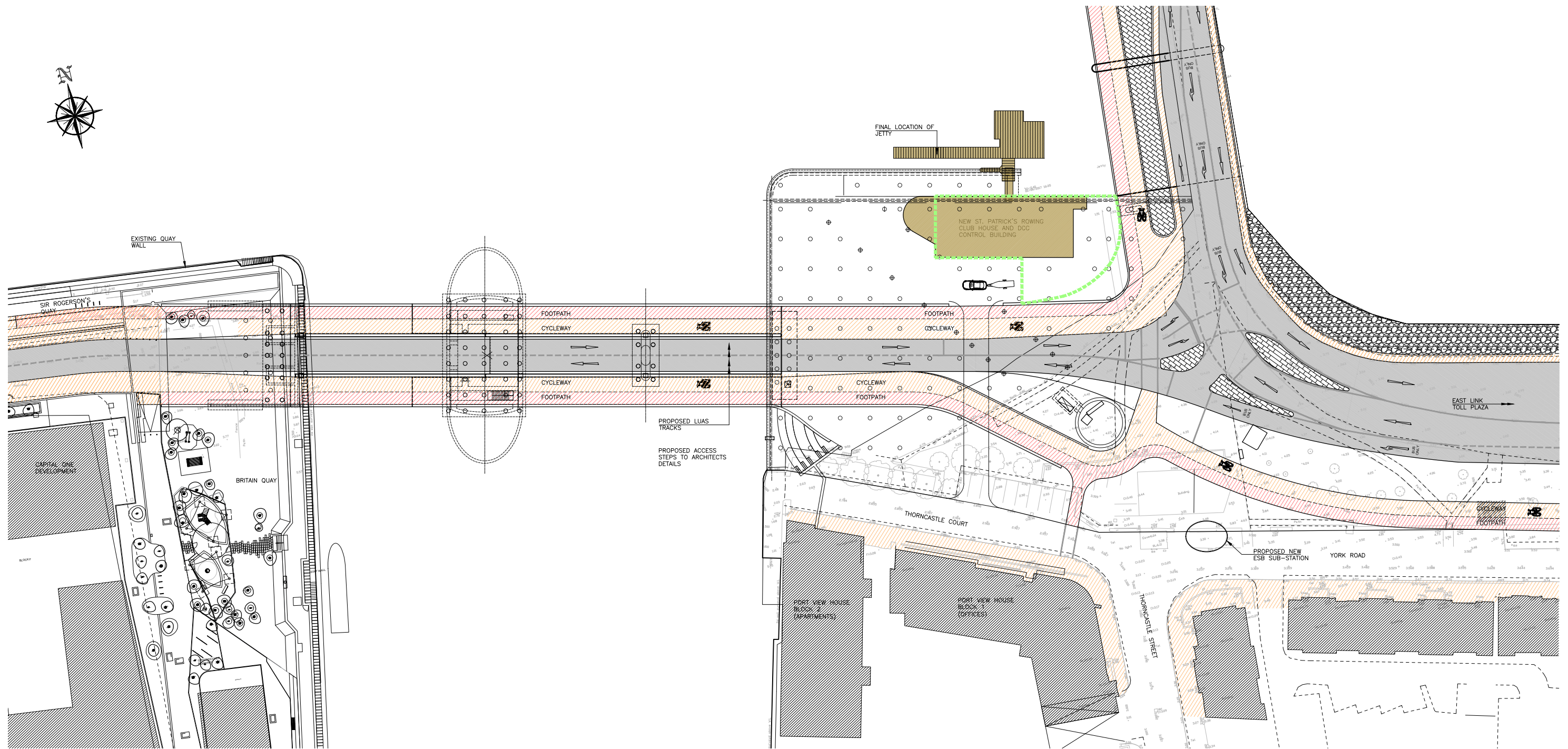

Arena House, Arena Road, Sandycove, Dublin 18, Ireland
t +353 (0) 1 294 0800
f +353 (0) 1 294 0820
www.rod.ie

Drawn	Designed	Checked	Approved	Suitability Code - Description
PE	CS	JK	TD	S3 - For Acceptance

Project Title		DODDER PUBLIC TRANSPORTATION OPENING BRIDGE			
Drawing Title		SCHEME CONSTRUCTION SEQUENCE SHEET 5			
Project	Originator	Volume	Location	Type	Role
DPTB	ROD	SBR	SWE	DRG	CV
Drawing Number	210405				
Scale (A1)	AS SHOWN	Date:	Sept. 2020	Job No:	17143
Rev:	P02				

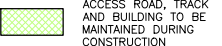

LEGEND:

-  EXISTING STONE RUBBLE RIVER FRONT
-  COMPLETED ST. PATRICK'S ROWING CLUB STRUCTURES AND ACCESS ROAD
-  CURRENT CONSTRUCTION STAGE GENERAL WORKS AREA
-  ACCESS ROAD, TRACK AND BUILDING TO BE MAINTAINED DURING CONSTRUCTION
-  EXISTING BUILDING TO BE DEMOLISHED
-  FINISHED ROAD SURFACE
-  CYCLE TRACK SURFACE
-  FINISHED FOOTPATH

GENERAL CONSTRUCTION SEQUENCE – PLAN – STAGE 5
(FINAL LAYOUT)
SCALE 1:400

CONSTRUCTION SEQUENCE:

1. COMPLETE PROVISIONAL LIAS TRACKS AND LANDSCAPE ALL RELATED AREAS.

NOTES:

1. LAYOUT, LIMITS AND LOCATION OF SHOWN PROPOSED ROADS AND STRUCTURES ARE BASED ON A PRELIMINARY LAYOUT AND ARE THEREFORE SUBJECT TO ADJUSTMENTS. ACCESS BETWEEN ST. PATRICK'S ROWING CLUB HOUSE AND JETTY ARE TO BE MAINTAINED DURING THE CONSTRUCTION PERIOD.
2. THE CONTRACTOR SHALL SUBMIT METHOD STATEMENTS, CALCULATIONS AND DRAWINGS TO THE ENGINEER FOR APPROVAL IN ORDER TO DEMONSTRATE THAT THE CONSTRUCTION METHOD WILL HAVE NO ADVERSE AFFECT ON THE PERMANENT WORKS.

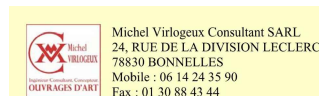

No.	Revision	Date	By	Chk'd	App'd
PO1	FOR ACCEPTANCE	22.09.20	DQ	JK	TD
PO2	ISSUED FOR REVIEW	26.01.21	OB	JK	TD



Arena House, Arena Road, Sandycroft, Dublin 18, Ireland
t +353 (0) 1 294 0800
f +353 (0) 1 294 0820
www.rod.ie

Project Title		DODDER PUBLIC TRANSPORTATION OPENING BRIDGE					
Drawing Title		SCHEME CONSTRUCTION SEQUENCE SHEET 6					
Project	Originator	Volume	Location	Type	Role	Number	
DPTB	ROD	SBR	SWE	DRG	CV	210406	
Scale (A1)	AS SHOWN	Date:	Sept. 2020	Job No:	17143	Rev:	P02

APPENDIX 3

RELEVANT EXTRACTS FROM GROUND INVESTIGATION REPORT

IGSL Ltd

**Dodder Public
Transportation Opening
Bridge**

**Geotechnical Interpretative
Report**

Project No. 21105

June 2020



**M7 Business Park
Naas
Co. Kildare
Ireland**

**T: +353 (45) 846176
E: info@igsl.ie
W: www.igsl.ie**

DOCUMENT ISSUE REGISTER

Distribution	Report Status	Rev.	Date of Issue	Author 1	Author 2
Roughan & O'Donovan	PDF by email	0	17.12.19	J. Lawler BSc MSc PGeo EurGeol FGS	P. Quigley BEng CEng MICE MIEI FGS RoGEP Adviser
Roughan & O'Donovan	PDF by email	1	12.06.20	J. Lawler BSc MSc PGeo EurGeol FGS	P. Quigley BEng CEng MICE MIEI FGS RoGEP Adviser

TABLE OF CONTENTS

Foreword

1. Introduction

2. Project Outline & Objectives

3. Fieldworks

3.1 Overwater

3.1.1 General

3.1.2 Cable Percussion Boreholes

3.1.3 Rotary Core Drillholes

3.1.4 Environmental Sampling – Dredge Samples

3.1.5 Geophysical Surveying

3.1.6 Setting Out and Surveying

3.2 Land

3.2.1 General

3.2.2 Cable Percussion Boreholes

3.2.3 Rotary Core Drillholes

3.2.4 Trial Pitting

3.2.5 Slit Trenching

3.2.6 GNI-attended Observation Pit

3.2.7 Dynamic Probing at Britain Quay

3.2.8 Geophysical Surveying

3.2.9 Utility & Precision Surveying

3.2.10 Window Sampling / Driven Sampling (Environmental)

3.2.11 Groundwater Monitoring

3.2.12 Setting Out & Surveying

4. Laboratory Analysis

5. Desk Study

5.1 Historic Land Reclamation

5.2 Industrial Heritage

5.3 1980's – Present

5.4 Liffey Tunnels

6. Ground Conditions & Engineering Properties of Soils and Bedrock

6.1 Ground Profile

6.1.1 Overwater Ground Conditions

6.1.1.1 Western Abutment (Bascule)

6.1.1.2 Eastern Abutment

6.1.1.3 Access Underpass

6.1.1.4 Land Reclamation / St. Patrick's Rowing Club

6.1.2 Land Ground Conditions

6.1.2.1 Eastern Bank

6.1.2.2 Western Bank / Britain Quay

6.2 Made Ground

6.3 Alluvial Deposits

6.4 Fluvial / Gravel Deposits

6.5 Glacial Till

6.6 Bedrock

6.7 Groundwater

6.8 Geotechnical Parameters

7. Ground Assessment & Recommendations

7.1 General

7.2 Foundation systems

7.3 Protection of Buried Concrete

7.4 Geotechnical Hazard & Risk Management Assessment

7.5 Ground Models

7.5.1 Main Dodder Transportation Opening Bridge & Eastern Approach

7.5.2 Land Reclamation, Access Underpass & relocated St. Patrick's Rowing Club

References

FIGURES

- Figure 1A & 1B - Site Location Plan – Proposed River Dodder Opening Bridge
- Figure 2 - Jack-up barge at Location 510
- Figure 3A - Very soft black SILT being retrieved by augering at RC512A
- Figure 3B - Intact Limestone pictured in the core barrel recovered using Geobore S coring
- Figure 4 - Britain Quay Cross Section taken from Minutes of Proceedings of ICE, c. 1877/78
- Figure 5 - Excerpt from the Map of Dublin by Brooking (1728) showing 'The River Liffe' and 'Sir John Rogerson's Quay'
- Figure 6 - Manufacturing at North Wall and Sir John Rogerson's Quay, 1846 (City view) (Goodbody, 2014)
- Figure 7A - 7D - Maps / Drawings showing development of the site through the 19th and early 20th centuries
- Figure 8 - Grand Canal Docks and Sir John Rogerson's Quay, 1926 (Dublin Port and Docks Board, 1926)
- Figure 9A & 9B - View of Thorncastle Street from the North Quays during the toll bridge construction.
- Figure 10 - Construction of the R131 road on its eastern approach to the bridge (in the foreground) (Bridges of Dublin, n.d.)
- Figure 11 - View over the East Link Bridge showing the eastern end of Sir John Rogerson's Quay / Britain Quay taken from the North Wall.
- Figure 12A – 12E - Development at the River Dodder confluence with the River Liffey 1995 – Present Day.
- Figure 13 - Aerial view of the bridge site dated c. 2005.
- Figure 14 - Longitudinal Section under the River Liffey showing the tunnel Construction (From Nicholls, 1929)
- Figure 15 - Multibeam Bathymetric results showing channel scouring along Britain Quay.
- Figure 16 - Core recovery in RC512A illustrating Till to Bedrock transition
- Figure 17 - Works on land east of the River Dodder (Taken from Appendix 1)
- Figure 18A – 18C - Made Ground on southern approach pictured during bridge construction, dated 1983 (Bridges of Dublin, n.d.)
- Figure 19A & 19B - Historic location of South Quay Wall at Thorncastle Street
- Figure 20A & 20B - Made Ground / Fill Profile with underlying Silts in Slit Trench ST01
- Figure 21 - SPT data plot Vs depth for Made Ground strata in Land Boreholes
- Figure 22 - Quaternary Geology of Ireland, Sediments Map for Dublin City / South Dublin
- Figure 23A - SPT data plot Vs depth for Alluvium / Marine Beach Sands strata in Land Boreholes
- Figure 23B - SPT data plot Vs depth for Alluvium strata in Overwater
- Figure 24 - Grading Envelope for Alluvial Sediments found in Cable Percussion boreholes including undifferentiated fluvial deposits
- Figure 25 - Atterberg Limit Plot (Alluvial Sediments)
- Figure 26 - Grading Envelope for fluvio-glacial Gravel Deposits found in Cable Percussion boreholes
- Figure 27 - Atterberg Limit Plot (Glacial Deposits)
- Figure 28 - Grading Envelope (Glacial CLAY / Till)
- Figure 29 - SPT data plot Vs depth for CLAY and CLAY/SILT deposits across the site
- Figure 30 - Cored Glacial Deposits transitioning into upper Rockhead in Corehole RC511
- Figure 31 - Bedrock Geology Map for the Area

- Figure 32 - Core Recovery in RC504
- Figure 33 - $I_s(50)$ strengths obtained from diametrial Point Load Strength Index testing
- Figure 34 - UCS strengths (MPa) obtained from core testing
- Figure 35A & 35B - Made Ground / Fill Profile in Slit Trench ST02B & ST03
- Figure 36 - Section of 2D Shear Modulus for MA04 conducted north of the South Quay Wall off Thorncastle Street (in kPa)
- Figure 37 - Jack-up drilling platform hoisted over mudflats at low tide during drilling works at RC512A

TABLES

Table 1	- Rotary drillhole standpipe installations together with response zones
Table 2	- Geological profile of the South Shaft of the Liffey Tunnel based on Nicholls (1929)
Table 3	- Geological profile of the North Shaft of the Liffey Tunnel based on Nicholls (1929)
Table 4	- Summary Details of Ground Profile at Overwater Exploratory Locations. Note rotary coring methods utilised on site were both Conventional (Conv) and by Geobor S methods (GBS).
Table 5	- Exploratory Hole Locations east of the River Dodder
Table 6	- Exploratory Hole Locations west of the River Dodder
Table 7	- Thickness of Made Ground established in drillholes, boreholes, trial pits, slit trenches and window samples
Table 8	- Summary Details of In-situ Vane Testing in Exploratory Boreholes
Table 9	- Summary Details of Triaxial Tests on Alluvial Soils
Table 10	- Summary Details of Consolidation Tests on Alluvial Soils
Table 11	- Summary of Consolidated undrained Triaxial Compression testing with pore pressure measurement on Alluvial soils in overwater boreholes
Table 12	- Thickness of medium dense / dense GRAVEL measured in boreholes and drillholes across the site
Table 13	- Thickness of glacial tills as recorded in cable percussion boreholes and rotary drillholes at each of Britain Quay, Overwater Section and East of R. Dodder areas.
Table 14	- Summary Details of Triaxial Multistage Tests on Glacial Till Soils recovered in Geobore S
Table 15	- Summary Details of Triaxial Tests on Geobore S - cored Glacial Tills
Table 16	- Summary Details of Consolidation Tests on over-consolidated Glacial Soils
Table 17	- Summary Detail of Corehole Lithologies
Table 18	- Unconfined Compressive Strength [UCS] test results from Land-based coreholes
Table 19	- Unconfined Compressive Strength [UCS] test results from Overwater coreholes
Table 20	- Water ingress in cable percussion borehole and rotary core drillhole locations
Table 21	- Derived Geotechnical Parameters
Table 22	- Sulphate (2:1 Water Soluble) as SO ₄ Exceedances Over BRE DS-1 category as per Table C1 in Concrete in aggressive ground (2005)
Table 23	- Geotechnical Hazard (Risk Factors) Assessment for River Dodder Crossing

APPENDICES

- Appendix 1 - Exploratory Hole Site Plan
- Appendix 2 - Stratigraphic Cross-sections / Ground Models
- I. South Alignment W-E
 - II. North Alignment W-E
 - III. Possible Gravel Channel
 - IV. North Shore & St Patrick's Rowing Club
 - V. St Patrick's towards Access Underpass
- Appendix 3 - Values pertaining to Concrete Aggressivity - Soil
[pH, Sulphate & Chloride contents]

FOREWORD

The following conditions and notes on the geotechnical site investigation procedures should be read in conjunction with this report.

Standards

The ground investigation works for this project (**Dodder Public Transportation Opening Bridge – Ground Investigation**) was carried out by IGSL in accordance with Eurocode 7 - Part 2: Ground Investigation & Testing (EN 1997-2:2007). This has been used together with complementary documents such as BS 5930 (2015) and BS 1377 (Parts 1 to 9) and the following European Norms:

- EN 1997-2 Eurocode 7: 2007 – Geotechnical Design – Part 2: Ground Investigation & Testing
- EN ISO 22475-1:2006 Geotechnical Investigation and Sampling – Sampling Methods & Groundwater Measurements
- EN ISO 14688-1:2017 Geotechnical Investigation and Testing – Identification and Classification of Soil, Part 1: Identification and Description
- EN ISO 14688-2:2017 Geotechnical Investigation and Testing – Identification and Classification of Soil, Part 2: Principles for a classification
- EN ISO 14689-1:2017 Geotechnical Investigation and Testing – Identification, description & classification of rock

Reporting

No responsibility can be held by IGSL Ltd for ground conditions between exploratory hole locations. The engineering logs provide ground profiles and configuration of strata relevant to the investigation depths achieved and caution should be taken when extrapolating between exploratory points. No liability is accepted for ground conditions extraneous to the investigation points. Unless specifically stated,

This report has been prepared for Dublin City Council and Roughan & O'Donovan Consulting Engineers and the information should not be used without the prior written permission of either party. IGSL Ltd accepts no responsibility or liability for this document being used other than for the purposes for which it was intended.

1. INTRODUCTION

At the instruction of Roughan & O'Donovan [ROD] Consulting Engineers on behalf of their client, Dublin City Council, IGSL Limited has undertaken a programme of both land-based and overwater geotechnical site investigation works to enable the preliminary planning and design of the proposed River Dodder Public Transportation Opening Bridge (Figure 1A). The ground investigation scope was designed to inform the construction of approach roads associated with the bridge; the construction of a new control building for the bascule bridge; the provision of a new club house and facilities for St Patrick's Boat Club; and the reclamation of land to the west of Tom Clarke Bridge (formerly the East-Link Toll Bridge). The overwater works were completed across the River Dodder at its confluence with the River Liffey. A modular jack up barge facilitated the construction of the overwater element of the works (Figure 2).

Figure 1A & 1B – Site Location Plan – Proposed River Dodder Opening Bridge



Fig 1A reproduced from drawing 'Outline Scheme Proposals Sheet 1' retrieved from Consultation. Dublin City website <https://consultation.dublincity.ie>

Fig 1B reproduced from Google Maps 2018

Land-based exploratory works were located west of the proposed bridge at Britain Quay / Sir John Rogerson's Quay and east of the bridge between York Road / Thorncastle Street and the R131 East Link Road / Tom Clarke Bridge. Slit trenching works were positioned at each bridge approach. This included road crossings on the R131 East Link Road, Thorncastle Street and Britain Quay.

The mounded grass area on the eastern bank houses the access shaft to the Liffey Services Tunnel. The Liffey Tunnel and a Gas Networks Ireland [GNI] 40-bar high pressure gas pipeline extend northwest and north from the shaft under the River Liffey towards North Wall Quay. In

addition to these recent tunnelling projects, the DCC Liffey Tunnel (constructed in the late 1920's) runs across the river under Tom Clarke Bridge to the North Quay. Throughout the GI works, consultation was maintained with the various stakeholders concerning their buried infrastructure. Murphy Surveys were contracted to undertake GPR surveying on the aforementioned infrastructure ahead of excavation being permitted by the service owners. A slit trench was also undertaken on North Wall Quay to pinpoint the location of the existing GNI pipeline.

The geotechnical investigations were supervised by an IGSL geotechnical engineer. The fieldworks included a combination of overwater and land-based boreholes / coreholes (cable percussion boreholes with employment of both rotary conventional and Geobore-S coring methods). As mentioned previously, the overwater holes were undertaken from a jack-up barge. Given the shallow intertidal mudflats at the mouth of the Dodder, the jack-up barge could only be moved at or near high tide. For this reason, shallow-draft lightweight power boats were used to manoeuvre the barge throughout the project. The barge was positioned using GPS systems. The drillholes across the bridge line extended to depths of between 13.50m below river bed (-15.04m OD) and 31.15m below river bed (-33.78m OD). Coreholes on land achieved depths of between 2.10m (1.88m OD) and 35.70m (-31.98m OD).

The field investigations were executed in accordance with BS 5930, Code of Practice for Site Investigations (2015) and EN 1997-2 Eurocode 7 Part 2 Ground Investigation & Testing. Given the brownfield nature of the site coupled with its Yellow categorisation (British Drilling Association 'Guidance for Safe Intrusive Activities on Contaminated or Potentially Contaminated Land' (2008)) the investigation was carried out in accordance with BS 10175:2001, Investigation of Potentially Contaminated Sites: Code of Practice and the EPA Landfill Manual: Investigations for Landfill. Excavations and bores in the shallow land and marine soils were additionally supervised by an on-site archaeologist provided by Shanarc Archaeology. Laboratory testing was performed on a range of bulk disturbed and undisturbed samples (U100 & piston) as agreed with ROD Consulting Engineers. Environmental laboratory testing was conducted by RPS Mountainheath (UK) on sediment dredge samples and by Chemtest Laboratories in the case of contaminant assessment for land and riverbed samples.

This report presents the findings from the geotechnical and supplementary geophysical and bathymetric investigations and includes an evaluation of the field and laboratory test data. An interpretation of the exploratory boreholes and engineering properties of the superficial deposits and bedrock are presented. A ground assessment is presented in Section 7 and includes a discussion on the likely foundations for the proposed structure, concrete and steel protection and a geotechnical risk assessment. This Geotechnical Interpretative Report has been completed in accordance with EN1997-2 Section 6 which is related to the planning and reporting of ground investigations.

A separate Contamination Assessment Report [CAR] was prepared in accordance with the EPA document 'Environmental Risk Assessment for Unregulated Waste Disposal Sites (2007)'. This was undertaken by O'Callaghan Moran & Associates. Waste classification was also undertaken by O'Callaghan Moran & Associates. This classification process is required for waste soils likely to necessitate removal from the site as part of the proposed redevelopment works. Waste classification determines whether a waste can be sent for either recovery or disposal. The HazWasteOnline™ Classification Engine, developed in the UK by One Touch Data Ltd, was used in this determination.

2. PROJECT OUTLINE & OBJECTIVES

The project can be separated into two distinct parts; the overwater works and the land-based works. The following items detail the works undertaken for each:

Overwater Works:

- i. 11 no. cable percussion boreholes (prefixed BH-). In the case of BH518, a conventionally cored rotary drillhole, RC518, was formed through the cable percussion moonpool. In all other cases the rotary corehole (prefixed RC-) was drilled through a separate, dedicated moonpool on deck. Geobore S coring was used at nine of the corehole locations. Conventional air/mist coring was performed at three locations (RC504, RC506 & RC518).

In the case of RC512, early termination saw a second setup at RC512A. This followed the recovery of what was thought to be steel shavings in the flush returns of RC512 at 13.50m below river bed. The potential for the presence of buried tunnel infrastructure to be in place at this location and the consequence of striking same was enough to relocate the jack-up barge and re-drill. There was no cable percussion borehole formed at location 512A.
- ii. Five grab samples were taken for specialist dredge testing. The samples were extracted from the first 1m of very soft sediment.
- iii. Geophysical surveys were conducted by both Hydrographic Surveys and Minerex Geophysics. A bathymetric survey of the river bed was produced by Hydrographic Surveys. The resolution on the sub bottom profiling, the marine seismic refraction and the 1D MASW survey was limited by the thick accumulation of soft sediment overlying the deeper overburden and bedrock.

Land Works:

- i. 7 no. cable percussion boreholes were constructed on both the eastern and western banks of the Dodder. They extended to a maximum depth of 16.0m below ground level. Rotary follow-on drilling was conducted at six of these locations. Of the seven borehole locations, two of the locations were re-setups both having first encountered shallow obstruction in the originally bored hole, BH515 & BH516.
- ii. Given the potential for buried services to be present at each of the terrestrial locations, cable percussion holes and rotary-only holes were commenced with a services inspection pit. Logs and photographs for inspection pits at BH515 and BH517 and for RC516A and RC516B are presented in Appendix 11.
- iii. 1 no. machine-excavated trial pit at TP602 extended to a depth of 0.70m below ground level. Boulder-type obstructions were found across the base of the pit.
- iv. 7 no. slit trenches were undertaken, 6 of which were located on the eastern side of the River Dodder, with the seventh located on Britain Quay, west of the River Dodder (ST01). ST03 was carried out as nightworks under a Road Opening Licence and was excavated on the R131 Regional road, south of Tom Clarke Bridge.
- v. A trial hole was excavated on the campshire of North Wall Quay to locate the exact position of the 40-bar high pressure gas main prior to its crossing the river. The visual observations allowed for greater accuracy in determining the orientation of the pipe-crossing from north to south towards the Liffey Services Tunnel shaft.

A series of four heavy dynamic probes (DP01-DP04) were constructed on Britain Quay to confirm the stepped profile of the existing Quay Wall. To supplement historic information already to hand, a trial pit was also excavated on the land side of Britain Quay (TP601).

- vi. Three window samples were undertaken at Britain Quay (WS1 – WS3) extending to depths ranging 2.50 to 2.60m bgl. The window samples were requested by OCM Environmental Consultants. Environmental samples were subsampled from the recovered window sample soils.
- vii. A single land-based 2D MASW profile was undertaken by Minerex Geophysics. The profile, MA04, allowed for a transition to be drawn between soft sediments and higher velocity till / dense gravels.
- viii. Murphy Surveys undertook a utility survey to map the location of the high pressure 40-bar gas main which is located on both the north and south banks of the River Liffey. This was performed using both GPR equipment and a Radio detection RD8000 device. A precision survey was also undertaken to map both the north and south shafts of the DCC Liffey Tunnel.

The primary objectives of the works were as follows:

- Determine the composition, consistency and strength / stiffness of the superficial soils
- Establish the rockhead elevation, weathering profile, discontinuity characteristics and strength of the bedrock
- Recover samples for geotechnical and environmental laboratory testing in accordance with the requirements of the Employer's Representative
- Assess the ground conditions and develop geotechnical parameters for design

The locations of the investigatory boreholes are enclosed in Appendix 1. Geological / geotechnical cross-sections / ground models have been prepared using the borehole and rotary core drillhole findings. The sections are presented in Appendix 2.

3. FIELDWORKS

3.1 OVERWATER

3.1.1 General

The overwater geotechnical investigation was carried out during the months of July, August and September 2018 and comprised the following:

- Cable Percussion Boreholes (11 no.*)
- Rotary Core Drillholes (12 no.*)
- Geophysical Surveying
- Associated sampling & in-situ testing
- Setting out & surveying

*11 no. cable percussion holes were conducted through the jack-up. Both cable percussion and rotary works were formed at separate, dedicated moonpools. However, at BH/RC518 one moonpool was used for both drill strings. At RC512A, no cable percussion boring was undertaken.

The jack-up barge [Fastnet Jack 1] was supplied by Fastnet Shipping Limited of Bilberry Docks, Waterford. It was equipped with a Dando 3000 cable percussion boring rig and Knebel top drive rotary rig (Figure 2). Two moon pools were located at opposite corners of the working deck approximately 7m apart. They facilitated lowering of the respective steel casings into the riverbed. Given the intertidal aspect of the work area, an oil barrier / boom was not lowered into the river during works. Instead the oil boom was present on the barge ready for deployment in the case of an oil spillage. A geotextile screen was placed beneath the rigs to collect and filter the water produced during drilling.

Figure 2 – Jack-up barge at Location 510



Once the location of the borehole was set out, being positioned central to the jack-up, installation of casings commenced through both the cable percussion and rotary moonpools. In the case of cable percussion boring, once the 8" steel casing reached the riverbed, sampling and testing commenced

with conventional cable tool equipment and advanced until refusal occurred. For the Knebel rotary rig, similar 8" casing was lowered to the riverbed and then rotated downwards through the soft riverbed soils to refusal in the stiff upper glacial till. Solid stem augering returned the soft sediment to deck (Figure 3A). Once cleared of soft sediment, from this point Geobore S casing was lowered inside the casing with re-circulated flush deployed to facilitate core recovery in the glacial till. Geobore S triple-tube coring system in all cases (with the exception of RC512 which was terminated in the Clay) was advanced into the underlying bedrock (Figure 3B). As noted previously, the drillholes at the proposed bridge extended to depths of between 13.50m below river bed (-15.04m OD) and 31.15m below river bed (-33.78m OD).

Figure 3 – Fig 3A Very soft black SILT being retrieved by augering at RC512A; **Fig 3B** Intact Limestone pictured in the core barrel recovered using Geobore S coring



3.1.2 Cable Percussion Boreholes

The cable percussion boreholes (200mm diameter) were sunk using a Dando 3000 rig and employed conventional cable tool boring methods as outlined in the Foreword. Representative bulk disturbed samples were taken at approximately 1.0m intervals or change of stratum and sealed in polyethylene bags. Tub samples were also recovered between each bulk sample. Piston and U100 samples were attempted in the very soft and soft upper soils. Recovery was good measuring 90 to 100% in most samples.

Standard Penetration Tests (SPT's) were performed in the boreholes in accordance with Section 3.3, Part 9 of BS 1377 (1990). The SPT measures the number of blows required by a 63kg hammer falling through a drop height of 760mm to drive a cone or a split spoon a distance of 300mm through the soil. Prior to the commencement of the test, the cone or split spoon is driven an initial distance of 150mm into the soil and the number of blows for this penetration depth are recorded as the "seating blows". The subsequent blowcounts for each 75mm increment (300mm) of penetration are recorded and summated to give the 'N-Value' as reported on the borehole log. The seating and test blow counts are reported in brackets with the N-Value recorded accordingly, e.g., BH508 at 9.0m where 'N=14 (1, 1, 2, 2, 4, 6)'.

In-situ shear vane tests were conducted in the sediment in a number of the boreholes. The testing was undertaken largely in soils where SPT testing derived self-weight test drives indicative of very soft strata. Details of the soils (strata) encountered, SPT N-Values, vane results, samples recovered and chiselling durations are presented on the boring records in Appendix 1 of the factual report.

3.1.3 Rotary Core Drillholes

At all but one drillhole location, rotary drilling was carried out using a Unimog-mounted Knebel rotary rig. At RC518 a Comacchio 205 tracked rig was used. For the overwater holes, a combination of conventional and Geobore S coring methods were employed. For nine of the twelve drillholes, the Knebel drilling unit employed triple-tube Geobore S coring techniques producing 102mm diameter core samples. Recirculated water flush was used to promote sample recovery throughout coring. For RC504, RC506 and RC518, conventional air/mist coring was performed producing 79mm diameter cores.

The core samples were placed in 2m and 3m capacity timber boxes. Photographs of the cores were taken using a digital camera prior to logging on site by a senior engineering geologist. The boxes were then transported to IGSL's laboratory in Naas for laboratory testing. The core photographs are presented in Appendix 3 of the factual report.

The core log records include engineering geological descriptions of the cores, details of discontinuities and mechanical indices (TCR, SCR and RQD's) for each core run. It is noted that core comprised of overburden deposits do not form part of the SCR and RQD percentage values. Comments on casing details are included on the rotary records. The rotary drillhole records are presented in Appendix 3 of the factual report and reference should be made to the Foreword which provides details on the logging of the cores.

3.1.4 Environmental Sampling – Dredge Samples

Environmental samples were recovered from shallow grab samples. Extracted soils were placed in the appropriate vessels (plastic tubs & amber glass jars) which were then placed in cooled storage containers. A Chain of Custody form was completed for each batch of samples, listing the sample numbers, depths, types of vessels and the date of sampling. This was then signed by the sampling engineer and placed in the storage containers for dispatch to the environmental laboratory.

The containers and relevant Chains of Custody were transported by courier to the environmental laboratory, where they were placed in an appropriate sample storage facility. NIEA dredge sample analyses were undertaken in accordance with laboratory test schedules provided by IGSL Limited

and approved by ROD Consulting Engineers. In addition, Rilta sample analyses were also conducted on a range of samples recovered from cable percussion boring. The results of the analyses are presented in Appendix 16 (Rilta analysis) and 17 (NIEA Dredge analysis) of the factual report.

3.1.5 Geophysical Surveying

Hydrographic Surveys Limited undertook a bathymetric and geophysical survey consisting of a multibeam echosounder and a sub bottom profiling survey at the site. The survey objectives were to establish sea bed levels via the multibeam surveying technique and determine any sub bottom reflectors using the sub bottom profiling technique. The fieldworks were undertaken in mid-July 2018 ahead of mobilisation of the jack-up barge. Resolution of deep-seated reflectors proved difficult due to the thick drape of soft marine sediment across the site. A lack of signal penetration beyond the upper silt resulted in the data quality being insufficient to resolve depth to bedrock. Hydrographic Surveys findings are presented in Appendix 5 of the factual report.

Minerex Geophysics Limited carried out a geophysical survey consisting of marine seismic refraction and marine 1D MASW. Land-based 2D MASW was also undertaken. The key objectives of the survey were to determine the depth to rock and the overburden thickness and estimate the strength/stiffness of the overburden (superficial deposits) and rock quality. Unfortunately, as with the sub bottom profiling, the seismic energy did not penetrate the low velocity, very soft river bed sediments. Rather, the accumulation of very soft silt and mud-type sediments on the river bed served only to attenuate the seismic energy. It was therefore not possible to resolve refractions or surface waves from deeper layers like boulder clay or rock. The lack of seismic penetration is typical for these 'mud banks'. Gaseous organogenic sediments are thought present under the river, especially in the summer time, and this gas stops seismic energy from penetrating the ground. The findings of the Minerex geophysical survey are incorporated in Appendix 5 of the factual report.

3.1.6 Setting Out & Surveying

For the purpose of this contract, the exploratory locations were surveyed to Irish Transverse Mercator with ground levels (z) established to Malin Head. Setting out and surveying was undertaken by an IGSL engineer and the ground levels (m OD) and co-ordinates are shown on the engineering logs. The co-ordinates and elevations are presented on the field records with as-built drawings presented in Appendix 1.

3.2 LAND

3.2.1 General

The land-based geotechnical investigations were carried out in two phases. The first phase represented all of the works east of the River Dodder. These were carried out during the period October to December 2018 (with the exception of slit trench ST03 which was carried out in January 2019 under a Dublin City Council Road Opening Licence). The second phase of works was undertaken during August 2019 comprising all of the works on the western side of the Dodder. In their entirety the land works comprised the following:

- Cable Percussion Boreholes (7 no.ⁱ)
- Rotary Core Drillholes (6 no.)
- Trial Pits (2 no.)
- Slit Trenches (7 no.)
- GNI-attended Observation Pit (1 no.)
- Dynamic Probing (4 no.)
- Borehole / Corehole Inspection Pits
- Geophysical Surveying
- Utility and Precision Surveying
- Associated sampling & in-situ testing
- Setting out & surveying

ⁱ Two of the borehole locations were re-setups after both first encountered shallow obstruction (BH515 & BH516)

For the purposes of informing the Contamination Assessment Report, window sample locations were selected by the Environmental Scientist. The locations were chosen based on the findings of the reported cable percussive boreholes / slit trenches and based on the findings of the Tier 1 Site Assessment as per the EPA Code of Practice: Environmental Risk Assessment for Unregulated Waste Disposal Sites.

- Window Sampling (3 no.)
- Setting out & surveying

3.2.2 Cable Percussion Boreholes

The cable percussion boreholes (200mm diameter) were sunk using both Dando 2000 and Dando 3000 rigs and employed conventional cable tool boring methods as outlined in the Foreword. At each cable percussion hole, a 1.25m deep hand-dug service inspection pit was first excavated (Appendix 11). Once the area was proven free of buried services, cable percussion boring commenced. Representative bulk disturbed samples were taken at approximately 1.0m intervals or change of stratum and sealed in polyethylene bags. Environmental glass jar samples were taken at similar intervals. Tub samples were also recovered between each bulk sample. Thin-walled piston samples were attempted where soft and very soft soils were encountered.

Standard Penetration Tests (SPT's) were performed in the boreholes in accordance with Section 3.3, Part 9 of BS 1377 (1990). The SPT measures the number of blows required by a 63kg hammer falling through a drop height of 760mm to drive a cone or a split spoon a distance of 300mm through the soil. Prior to the commencement of the test, the cone or split spoon is driven an initial distance of 150mm into the soil and the number of blows for this penetration depth are recorded as the "seating blows". The subsequent blowcounts for each 75mm increment (300mm) of penetration are recorded and summated to give the 'N-Value' as reported on the borehole log. The seating and test blow counts are reported in brackets with the N-Value recorded accordingly, e.g., BH501 at 3.0m where 'N=15 (1, 2, 3, 4, 5, 3)'.

Rotary follow-on drilling was conducted at six of the seven bore locations. Details of the soils (strata) encountered, SPT N-Values, samples recovered and chiselling durations are presented on the boring records in Appendix 2 of the factual report.

3.2.3 Rotary Core Drillholes

In the case of the land-based holes, conventional coring methods were employed at six locations producing 78mm diameter cores. It is noted that Standard Penetration Tests were also performed in the land-based drillholes in both overburden and in generally shallow, highly weathered bedrock.

In the case of RC516, the core log shows that concrete was encountered in the rotary hole at 1.90m bgl. For this reason, in light of the congested nature of services in the area, an alternative location was considered for the rotary hole. Hence inspection pits RC516A and RC516B were constructed. Logs and photographs for these pits are presented in the factual report in Appendix 11. Once IPRC516A was proven free of buried services, rotary core drilling commenced.

The core samples were placed in 3m capacity timber boxes and transported to IGSL's laboratory in Naas for logging by a senior engineering geologist. Photographs of the cores were undertaken with a digital camera prior to logging and subsequent sample selection for laboratory testing. These photographs are presented in Appendix 4 of the factual report.

Groundwater monitoring standpipes were installed in two of the coreholes (See Table 1). The standpipes consisted of 50mm diameter HDPE pipework with proprietary 1mm slots and incorporated a pea gravel filter pack and cement / bentonite grout seal. Flush headwork covers were concreted in place following well installation. The core log records include engineering geological descriptions of the cores, details of discontinuities and mechanical indices (TCR, SCR and RQD's) for each core run. The rotary drillhole records are presented in Appendix 4 of the factual report and reference should be made to the Foreword which provides details on the logging of the cores.

Table 1 - Rotary drillhole standpipe installations together with response zones

RC No.	RC Final Depth	Response Zone	Base Backfilled	Dip Records m bgl
RC501	34.50	13.0-15.0	15.0-34.50	3.70 (30-08-19)
RC516A	35.40	5.80-8.0	8.0-35.40	-

3.2.4 Trial Pitting

Two trial pits were undertaken on site - one on the western bank of the River Dodder and one on the eastern side. Trial pitting was performed using a rubber-tracked excavator with hand digging deployed during shallow excavation as the presence of services could not be completely discounted. Trial pit TP601 was undertaken on 19th September 2019 with TP602 on 24th October, 2018. The trial pits were each logged and sampled by an IGSL geotechnical engineer in accordance with BS 5930 (1999+A2:2010).

Bulk samples (typically 20 to 30kg in weight) were placed in a heavy-duty polyethylene bags and sealed before being transported to Naas, County Kildare for laboratory testing. Environmental samples were also recovered. Trial pit TP601 was excavated down the side of the existing Britain Quay wall. TP602, positioned on a grassed area east of the River Dodder, encountered shallow obstructions in the form of buried boulder-type material. Both were backfilled with as-dug arisings and reinstated to the satisfaction of IGSL's site engineer. The trial pit logs are presented in Appendix 7 of the factual report and include descriptions of the soil encountered, groundwater conditions and stability of the pit sidewalls.

3.2.5 Slit Trenching

Slit trenches were excavated at seven locations as specified in the ROD scheduling document (Schedule 2: Exploratory Holes and Testing for Contract). Trenches were performed using a rubber tracked excavator and dug to a maximum depth of 2.50m bgl. As with trial pitting, bulk disturbed samples (typically 30 to 40 kg) were taken as trenching progressed. The samples were placed in heavy-duty polyethylene bags and sealed before being transported to Naas for laboratory testing. When on grassed areas, the trenches were backfilled with as-dug arisings. Specialist contractors were tasked with the more sensitive reinstatement of the grassed area at Capital Dock (ST01). In the case of ST03, the slit trench was backfilled in accordance with the Department of the Environment "Guidelines for the Opening, Backfilling and Reinstatement of Trenches in Public Roads".

A detailed record of the depth, diameter and type of each service encountered within the trench is detailed in Appendix 8 of the factual report. The soil profile provided on the slit trench logs describes the majority of the soils across the transverse trench. The location of trench extremities (X and Y) has been surveyed to ITM using GPS techniques.

3.2.6 GNI-attended Observation Pit

An observation pit was excavated on the campshire of North Wall Quay to locate the position of the 40-bar high pressure gas main prior to its crossing the river. This was undertaken by a three-man crew supplied by Richard Nolan Civil Engineering. The crew, under the supervision of both an IGSL and a GNI representative, used machine-assisted hand-digging to locate the steel pipe. The visual observations made allowed for greater accuracy in determining the orientation of the pipe-crossing from north to south across the Liffey towards the Liffey Services Tunnel shaft. The excavation works were set out using an existing Murphy Surveys utility survey. The findings of the dig are presented in Appendix 9 of the factual report.

3.2.7 Dynamic Probing at Britain Quay

In-situ "Heavy" dynamic probing (DPH) was performed at four locations using a Dando Terrier crawler rig. The Terrier unit meets the requirements of BS 1377, Part 9 (1990) and IS EN 1997-2:2007. The probe holes were constructed on the landside of Britain Quay wall to assess the presence of a stepped profile as depicted in scaled drawings featured in the "Minutes of Proceedings of The Institute of Civil Engineers, Vol. LI. Session 1877_78 Part 1" (refer to Figure 4).

Figure 4 – Britain Quay Cross Section taken from Minutes of Proceedings of ICE, c. 1877/78

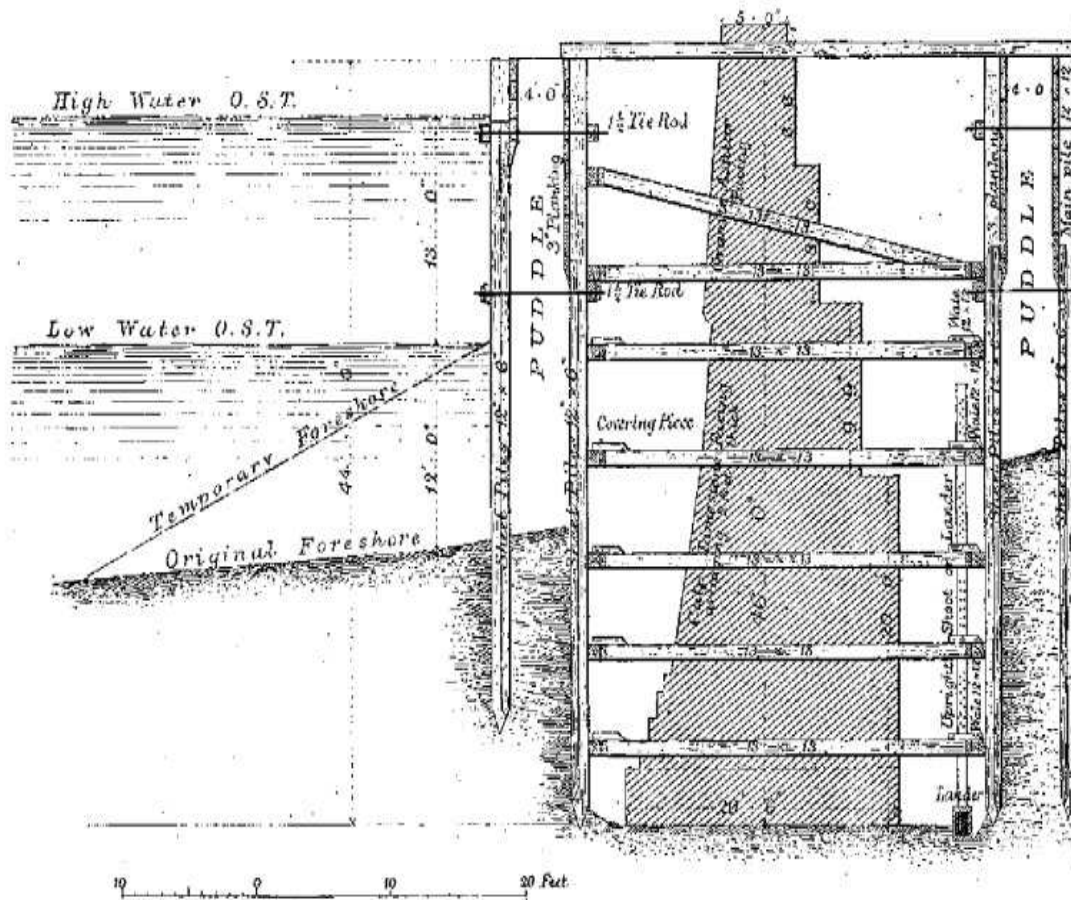

Minutes of Proceedings of The Institution of Civil Engineers. Vol. LI. Session 1877-78. Part 1.

Ahead of the probes being undertaken, a trial excavation (TP601) was first excavated to allow for visual inspection of the quay wall and for the recovery of environmental samples. The pit was excavated using an 8t tracked excavator. The pit record is presented separately in Appendix 7 of the factual report along with photographs taken on the day.

The probing rig utilized a 50kg drop weight and 500mm drop height with a 60° cone. In accordance with the standards, the number of blows required to drive the cone each 100mm increment into the sub-soil was recorded. Probing is generally terminated when blow counts, N_{100} values, exceed 25, in order to avoid damage to equipment. The probe records are presented in the factual report in Appendix 10 and include blow-counts in both numerical and graphical format.

3.2.8 Geophysical Surveying

Although the main scope of Minerex Geophysics work was marine-based, a single land-based 2D MASW profile was taken (MA04). The objective of the profile was to obtain a profile of shear wave velocity versus depth and to calculate the small strain shear modulus G_{max} from the shear wave velocities. Shear wave velocities between 150 and 600 m/s were obtained allowing a transition to be marked between relatively soft or loose sediments to higher velocity horizons indicative of stiff glacial till / dense gravels. The findings of the Minerex land-based geophysical survey are incorporated in their report in Appendix 6 of the factual report.

3.2.9 Utility & Precision Surveying

Murphy Surveys Limited conducted a Ground Penetrating Radar [GPR] survey both north and south of the River Liffey. They were tasked with plotting the line of the high pressure 40-bar gas main which exists on both banks before crossing the Liffey. Using both GPR and a Radio detection RD8000 receiver and transmitter they surveyed the campshire on North Wall Quay and the approach to the Liffey Services Tunnel shaft on the south bank near St Patrick's Boat Club. Murphy Surveys also undertook a precision / topographic survey of the DCC Liffey Tunnel shafts both off Thorncastle Street and at North Wall Quay. Their report is incorporated in the factual report in Appendix 12.

3.2.10 Window Sampling / Driven Sampling (Environmental)

Window sampling was carried out at three locations using a Dando Terrier rig. The sampling was scheduled by an Environmental Scientist following review of the intrusive investigation logs available in addition to a Tier 1 Site Assessment as per the EPA Code of Practice: Environmental Risk Assessment for Unregulated Waste Disposal Sites. The window samples were recovered at three locations on Britain Quay / Sir John Rogerson's Quay.

The Terrier rig uses a 63.5kg weight to drive the window sampler and the material is retrieved in a semi-rigid plastic core liner. The window sample records are presented in Appendix 13 of the factual report and include descriptions of the soils encountered and the total recovery per run.

3.2.11 Groundwater Monitoring

Groundwater monitoring was undertaken following the fieldworks period. Groundwater levels were measured using an electric dipmeter in the case of BH501. For BH516 on the eastern bank of the Dodder, a data logger was placed in the well to assess hourly fluctuations in water level over the course of a month from early February to early March 2019. The levels recorded are reported in Appendix 14 of the factual report.

3.2.12 Setting Out & Surveying

For the purpose of this contract, the exploratory locations were surveyed to Irish Transverse Mercator with ground levels (z) established to Malin Head. Setting out and surveying was undertaken by an IGSL engineer and the ground levels (m OD) and co-ordinates are shown on the engineering logs. The co-ordinates and elevations are presented on the field records and with as-built drawings presented in Appendix 20 of the factual report.

4. LABORATORY ANALYSIS

Geotechnical laboratory testing was performed at IGSL's INAB-accredited laboratory in accordance with the methods set out in BS1377; British Standard Methods of Test for Soils for Civil Engineering Purposes; British Standards Institute:1990. Soils testing included particle size grading, moisture content and Atterberg Limits (Liquid / Plastic Limits) among others. Geotechnical classification testing was not undertaken on soil samples from BH515A due to the presence, noted in the driller's logs, of possible "asbestos pipe fragments". The geotechnical results are presented in Appendix 15 of the factual report.

Chemical analysis comprising pH and sulphate (SO₄) in addition to chloride, organic matter and loss on ignition testing was performed on nominated soil samples. This was undertaken by Chemtest Laboratories (UKAS accredited). Soil samples from BH517 were dispatched to Nicholls Colton Laboratories (UKAS accredited) to determine total sulphur, water soluble sulphate and oxidisable sulphide (in lime with TRL 447 methods), pH, organic matter and chlorides. The results are presented in Appendix 16 of the factual report.

Numerous soil samples from trial pits, boreholes (both land-based and overwater holes) and window samples were selected for Waste Acceptance Criteria (WAC) analysis to the *Rilta* Suite. The findings are used to assess the geo-environmental characteristics of the material with regard to disposal to an inert landfill. The environmental test results are also enclosed in the Chemtest reports enclosed in Appendix 16 of the factual report.

Environmental analysis was also conducted on four riverbed sediment samples to classify and assess their suitability for disposal. The testing was undertaken by UKAS-accredited RPS Mountainheath Laboratories. The laboratory test results are presented in Appendix 17 of the factual report.

Geotechnical laboratory testing was carried out on selected rock cores in accordance with ISRM. Point load strength index (PLSI) and unconfined compressive strength (UCS) tests formed the bulk of the geotechnical laboratory test records and are contained in Appendix 18 of the factual report along with direct shear analysis and deformability of rock in uniaxial compression reports. Chemical analysis tests (i.e. sulfur, sulfate & derivation of equivalent pyrite contents) were undertaken by Nicholls Colton (UKAS accredited) on selected rock core samples. The results are enclosed in the aforementioned factual report in Appendix 19.

5. DESK STUDY

5.1 Historic Land Reclamation

The location of the site at the confluence of the River Dodder and River Liffey makes it a significant feature and one easily identifiable on historic maps. The sprawling development of Dublin City looked to the east in the late 17th / early 18th centuries. Up until that point the area east of Hawkins Street was referred to as slobland. By 1700 William Mercer had been granted permission to reclaim and infill slobland beyond Hawkins Street to Mercers Dock (now Georges Quay) (Lennon, 2008). In 1707 the Corporation for Preserving and Improving the Port of Dublin was established, later known as the Ballast Office. The city authorities reclaimed an area further east which became known as City Quays. Beyond City Quays lay a 133-acre fee-farm estate comprising sand-swept marshland from Lazy Hill / Lazar Hill (Townsend Street) to Ringsend. Sir John Rogerson leased this land from the City Corporation. At this time, there was also a narrow strip of land just east of the Dodder, bounded by the spit of Ringsend. The following is an abstract from the Irish Historic Town Atlas (Lennon, 2008) which describes the consequence of river dredging on the southern banks of the Liffey which began the reclamation c. 1710.

“By the late 1720’s, he (Sir John Rogerson) had constructed a wall and quay that stretched to the mouth of the Dodder and backfilled the strand with gravel, sand and stones. It was the largest and most significant privately funded development in the embankment of the Liffey at Dublin. On the reclaimed area, a system of gridded streets was established and the city planned the development of fifty-one plots that became known as the South Lotts.”

(Lennon, 2008)

Figure 5 – Excerpt from the Map of Dublin by Brooking (1728) showing ‘The River Liffe’ and ‘Sir John Rogerson’s Key’



The existing South Wall to the east of the Dodder confluence came into service in 1793. The Grand Canal Dock was opened in 1796 attracting warehouses and manufacturing sites around it. It is thought that the Britain Quay wall section was reconstructed when the entry lock system for the Grand Canal Docks was built in 1795 (Bunbury, 2008).

5.2 Industrial Heritage

The establishment of the Alliance Gas Company in 1835 at Sir John Rogerson's Quay confirmed the concentration of Dublin's gas production in a restricted area, but more importantly close to the port facilities for the importation of coal (Goodbody, 2014). Between 1870 and 1888, the Port engineer Bindon Blood Stoney and contractors such as William J. Doherty rebuilt nearly 4,000ft of quay wall between Creighton Street and (Great) Britain Quay, as well as deepening the river channel by 23ft (Bunbury, 2008). The lands directly south of the quay were then made available for warehousing and industry. They were soon smothered in chemical works, coke furnaces, abattoirs, tar-pits, timber yards, foundries and gasworks (Figure 6).

Figure 6 - Manufacturing at North Wall and Sir John Rogerson's Quay, 1846 (City view)
(Goodbody, 2014)



Figure 7 tracks the development of the site through the 19th and early 20th centuries. At the turn of the twentieth century at Sir John Rogerson's Quay a Chemical Works labelled as "*Chemical Manure & Oilcake Mills*" is present on the OSI drawing. Here it is likely that coal-burning by-products such as chemical manure, guano and sulphuric acid were manufactured. A cornstore was located on (Great) Britain Quay taking the form of a triangular hatched area (Bunbury, 2008). Contemporaneously, a Bottle Works is present off Thorncastle Street. The Grand Canal Docks area, namely Charlotte Quay, was the site of glass bottle manufacture from 1787. The Irish Glass Bottle Company was established in Ringsend in 1871. Sited at the corner of South Docks Road and Ringsend Road, the company made black bottles for porter with sand from Dublin Bay and lime and clay from Clontarf. These were mixed with salt rock and soda and melted in a huge tank furnace (Dublin City, 2010). It is unclear as to the extent of "*Bottle Works*" at Thorncastle Street.

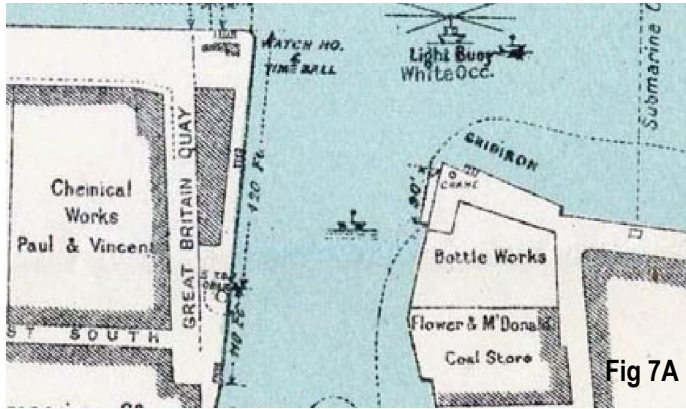

Fig 7A

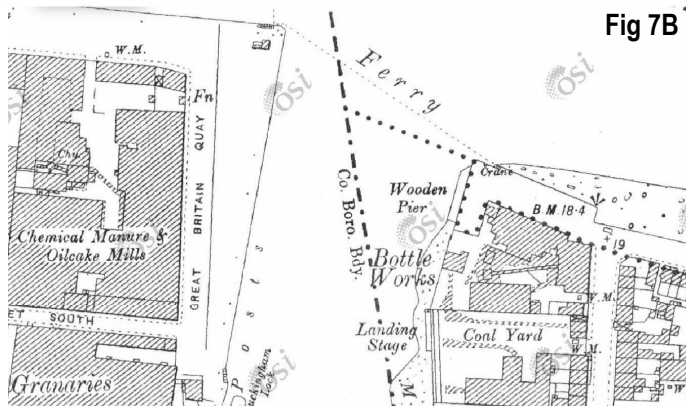

Fig 7B



Fig 7C

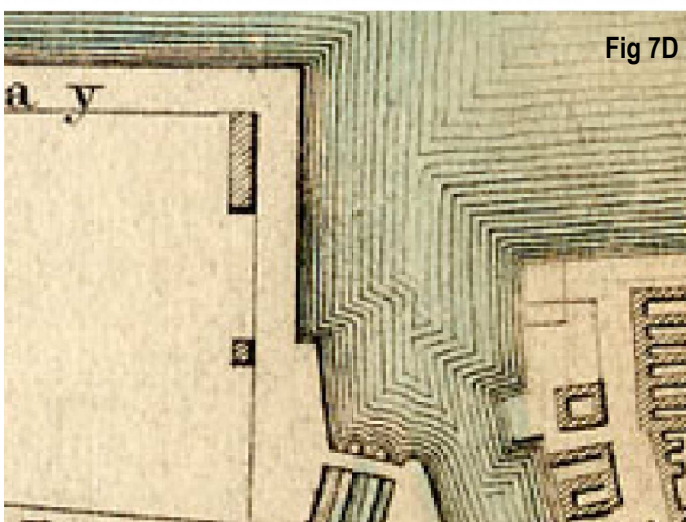

Fig 7D

Figure 7A, 7B, 7C & 7D –
 Figure 7A - a 1926 drawing of the Grand Canal Docks featured in *The Port of Dublin, Official Handbook* (Dublin City, n.d. A). The drawing shows the existence of a Chemical Works on the west bank of Sir John Rogerson’s Quay. A bottle works and coal store are present on the eastern side of the Dodder / Liffey confluence. Submarine cables are noted crossing the south bank of the Liffey close to where the future Liffey Tunnel would be built (1926 – 1929).

Figure 7B - Historical 25” drawing dated c.1888 – 1913 confirming the presence of “Bottle Works” and “Coal Yard”. The Chemical Works on Sir John Rogerson’s Quay is remarked as “Chemical Manure & Oilcake Mills”. The line of Britain Quay, as we know it, is present.

Figure 7C - Historical 6” drawing dated c.1829 – 1842 outlining the presence of Great Britain Quay and the shipping channels serving the Grand Canal Docks and the Dodder. Britain Quay had not yet been constructed.

Figure 7D – an 1833 drawing of the Grand Canal Docks from the Map Collection held in the Reading Room, Dublin City Library & Archive (Dublin City, n.d. A). Limited development exists on the western side of Great Britain Quay.

The breadth of industry between Hanover Quay and Sir John Rogerson’s Quay is evident in the aerial photograph (Figure 8) taken from The Official Handbook to the Port of Dublin (Dublin Port and Docks Board, 1926). An end to gas work furnaces was signaled by the rollout of electrification in the 1950’s and the eventual supply of natural gas to Dublin following the discovery of the Kinsale Gas Field in the early 1980’s (Bunbury, 2008).



Figure 8 - Grand Canal Docks and Sir John Rogerson’s Quay, 1926 (Dublin Port and Docks Board, 1926)

5.3 1980’s – Present

The installation of the opening span of the East Link Toll Bridge (now Tom Clarke Bridge) was completed in 1984. In a number of the photographs taken at the time, Thorncastle Street features as a backdrop. A collection of warehouses sit on the footprint of the now multistorey Portview apartments. The sheds may be those which feature in Figure 9E. The Quay wall can be seen in situ with some mounding of soil to the left foreground of the photograph. It is likely that its placement and that of the later cover of rock armour (present in Fig 9B) date from the development of the East Link Bridge (Figures 9A & 9B).



Figure 9A & 9B – View of Thorncastle Street from the North Quays during the toll bridge construction.

Figure 9A - Photo dating from 1984 taken during placement of the bridge’s opening span. (Bridges of Dublin, n.d.)



Figure 9B – Photo post the bridges opening in October 1984. Note the rock armour in place on the south banks of the river (Bridges of Dublin, n.d.)

Photographs featured on the Bridges of Dublin website (Bridges of Dublin, n.d.) document the development of the East Link Toll Bridge in the months before the bridge's official opening in October 1984. Figure 10 shows the development of the R131 approach road formed on the river side of the South Wall. In addition, a photograph looking SW across the bridge shows the grain silos located on Britain Quay (Figure 11). They can also be seen in Figure 12E (dated 1995) as circular structures near the Grand Canal Locks. The South Hailing Station (built 1907) can be seen sited on the corner of the main Liffey waterway and the entrance to Grand Canal Docks. This pink-coloured building was dismantled in 2007 (Archiseek, n.d.).

Figure 10 - Construction of the R131 road on its eastern approach to the bridge (in the foreground) (Bridges of Dublin, n.d.)



Figure 11 - View over the East Link Bridge showing the eastern end of Sir John Rogerson's Quay / Britain Quay taken from the North Wall. Pink-coloured Hailing Station appears in right foreground of photograph. (Bridges of Dublin, n.d.)





Figure 12A – 12E – Development at the River Dodder confluence with the River Liffey 1995 – Present Day.

Figure 12A - Google Maps 2017 satellite imagery showing development of Capital Docks on Britain Quay.

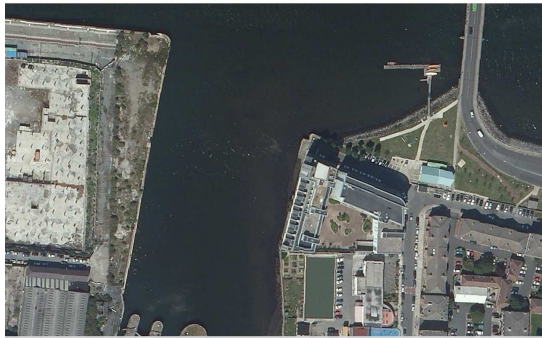

Figure 12B - Digital Globe Precision Aerial imagery (dated July 2011 – October 2013) showing derelict site on Britain Quay.



Figure 12C - Aerial Basemap 2005 orthophotography illustrating the derelict nature of Britain Quay and Sir John Rogerson’s Quay. Development of 7-storey tall Portview Apartments and adjoining 5- & 6-storey tall office units is complete. Works for the shaft of the Liffey Services Tunnel are apparent.



Figure 12D – Aerial Basemap 2000 orthophotography picturing the demolition of the existing warehousing at Thorncastle Street. A temporary site compound appears on the former green area at St Patrick’s Boat Club. Clearance work has removed all preexisting infrastructure at Britain Quay.



Figure 12E – OSI aerial orthophotograph (1995) shows what appears to be stockpiled rubble at Sir John Rogerson’s Quay. Rubble and silos exist at Britain Quay. A series of warehouses / sheds occupy the site south of Thorncastle Street east of the Dodder. Fig 12B – 12E reproduced from OSI website

(www.osi.ie)
 Ordnance Survey Ireland Licence No. EN 0070019
 © Ordnance Survey Ireland / Government of Ireland

5.4 Liffey Tunnels

Two subterranean tunnels containing multiple services and a third with a single high-pressure gas main cross the River Liffey in proximity to Thorncastle Street. They extend from the south bank of the river towards the North Wall.

Sited on the grassy embankment south of Tom Clarke Bridge (formerly the East Link Toll Bridge), the Liffey Services Tunnel was bored through a drive shaft from a level of approx. -14m OD. The tunnel was constructed using the pipe jacking method with a slurry shield Tunnel Boring Machine (Atkins, n.d.). The 260m long, 3m external diameter tunnel was received at a secant piled reception shaft located on North Wall Quay. The floor of the reception shaft measured approx. -17m OD (Atkins, 2002). Through the same southern shaft, the installation of a high-pressure gas pipeline was also facilitated. This was directed across the Liffey to a separate reception shaft at North Wall Quay. In this case, the direction of pipe jacking was almost parallel to Tom Clarke Bridge. 1.50m diameter jacking pipes were used in the installation of the gas pipeline tunnel. The crown of the pipeline measures approximately -13.2m OD (Bord Gais Eireann, 2000). The services tunnel construction period was from September 2006 until October 2008. The works area can be seen in Figure 13, an aerial image dated c.2005 taken from the Bridges of Dublin website (n.d.). Similar surface works can be seen in the aerial orthophotograph dated c. 2005 (Figure 12C).

Figure 13 – Aerial view of the bridge site dated c. 2005. Perimeter hoarding is present south of Tom Clarke Bridge at the location of the proposed tunnel shaft. (Bridges of Dublin, n.d.)



Table 2 – Geological profile of the South Shaft of the Liffey Tunnel based on Nicholls (1929)

SOUTH SHAFT		
Feet bgl	Metres bgl	Description
'First few feet'	'-	Made Ground
MG – 26ft	MG – 7.9m	SAND – becoming firm and grey
26 – 40ft	7.90 – 12.2m	Wet grey sticky CLAY [akin to Puddle CLAY]
40 – 55ft	12.20 – 16.8m	Very hard, gluey when wet, Boulder CLAY (Lumps of this clay when dried on the surface became nearly as hard as stone)
55 – 69ft	16.80 – 21m	Thin beds of grey SAND which merged into a thick bed of GRAVEL with some clay through it
69 – 76ft	21.0 – 23.2m	Hard CLAY with large uneven boulders
76 - 107	23.20 – 32.6m	Black LIMESTONE with shaley beds - the beds of soild rock being from 3ft to 4ft thick divided by 6 inches of shaley rock. Bed dip was 15degrees SE to NW. Rarely some shaley beds were noted to be 2ft in thickness.

Table 3 – Geological profile of the North Shaft of the Liffey Tunnel based on Nicholls (1929)

NORTH SHAFT		
Feet bgl	Metres bgl	Description
0 – 9ft	0 - 2.74m	Made Ground
9 – 18ft	2.74 – 5.49m	Fine SAND & GRAVEL
18 – 41ft	5.49 – 12.5m	Deep bed of coarse GRAVEL (full of water)
41 – 47ft	12.5 – 14.33m	CLAY (difficult to log as method used was 'Grabbing')
47 – 52ft	14.33 – 15.85m	GRAVEL (difficult to log as method used was 'Grabbing')
52 – 55ft	15.85 – 16.76m	CLAY (difficult to log as method used was 'Grabbing')
55 – 56ft	16.76 – 17.07m	Narrow bed of SAND
56 – 89ft	17.07 – 27.12m	Very hard, gluey when wet, Boulder CLAY (Lumps of this clay when dried on the surface became nearly as hard as stone) – Rare 'belts' of SAND Boulders were met in the CLAY immediately above rockhead
89 – 112ft	27.12 – 34.14m	Black LIMESTONE with shaley beds

6. GROUND CONDITIONS & ENGINEERING PROPERTIES OF SOILS AND BEDROCK

6.1 Ground Profile

For the purposes of this report, the over-water investigatory findings are presented and discussed separately to the land-based findings. A summary of the soil and rock profile for the over-water exploratory holes is shown in Table 4.

6.1.1 Overwater Ground Conditions

The geotechnical investigations conducted have revealed the ground conditions in the environs of the confluence of the River Dodder and River Liffey to consist of the following:

6.1.1.1 WESTERN ABUTMENT (BASCULE)

(503, 504, 505 & 506)

- In the area of the main Bascule pier, the level at which the river bed was met in the four boreholes varied from -4.32m OD to -1.65m OD. This represents a variation of 2.67m in river bed level. The bathymetric survey performed by Hydrographic Surveys noted the existence of a scoured channel along Britain Quay presumably where the River Dodder flushes away the low density river bed silts (Figure 15).
- Very soft black organic SILT was sampled across all overwater holes. Initially in the first 0.50m to 1.0m, the silt was recovered with the consistency of slurry. A putrid odour often accompanied the soils with abundant leaves, occasional organic roots, rootlets, rare nylon cloth and discarded plastic wrappers. In places, a hydrocarbon odour was recorded by the logging engineer. Wood fragments were noted at a depth of 5.0m brb [below river bed] in BH504.
- Variation from the very soft black organic SILT was noted in BH503 with pockets of light brown sand towards its stratigraphic base. These were logged at -9.32m OD (5.0m below river bed). Elsewhere, rare plastics were observed to -10.70m OD in BH504 (6.0-7.0m brb). An increasingly sandy fraction was noted entering the SILT in both BH505 and BH506. A hydrocarbon odour, occasionally remarked as 'strong' was noted in BH506 in the SILT near the soft SILT / TILL boundary.
- Very stiff glacial till was recorded in all of the Bascule pier boreholes. It was measured entering the stratigraphy from -10.95m OD to -11.12m OD (6.80m brb and 9.30m brb). Given its consistency, little penetration was possible with cable percussion boring despite use of the chisel. SPT testing repeatedly refused in the glacial till.
- Geobor S coring was completed at locations 503 and 505 with conventional coring undertaken at 504 and 506. The Geobor S coring produced 102mm diameter cores of very stiff CLAY overburden. In RC503, GRAVEL and sandy GRAVEL bands punctuated the clay sequence from 11.80m brb (-14.37m OD) to 13.30m brb (-15.87m OD). In RC505, a 300mm thick band of subrounded GRAVEL was logged in the very stiff CLAY from 13.60m brb (-15.20m OD) to 13.90m brb (-15.50m OD). Symmetrix openhole drilling through the overburden soils at both RC504 and RC506 did not record gravel or sand lenses. The method of drilling may not be conducive to documenting this stratigraphic detail.
- Of the four coreholes, both RC503 and RC504 reported a transition to rockhead with GRAVEL- and COBBLE-sized fragments of limestone within a firm and stiff grey brown CLAY matrix. Elsewhere, in RC505 and RC506, overburden passed to underlying rock without there being evidence of a weathered horizon. Rockhead was reported in Geobore S coring at near identical levels ranging -16.72m OD (14.15m brb) to -16.70m OD (15.10m brb) in RC503 and RC505. In conventional coreholes, RC504 recorded weathered rockhead from -17.98m OD (15.35m brb) with RC506 reporting rockhead at -18.17m OD

(16.20m brb). This represents more than a 1.0m difference in rock levels across the four pier locations. What it may also highlight is the limitation in using the combined symmetrix / conventional coring method when compared with Geobore S coring. Geobore S coring allows the logging engineer to pinpoint the transition from overburden to rockhead as the transition is generally recovered in a core run. With conventional coring however, the core barrel is used only when the driller assumes the ground is sufficiently competent to core. Openhole Symmetrix drilling may not accurately indicate the transition from very stiff overburden to rock.

Figure 15 – Multibeam Bathymetric results showing channel scouring along Britain Quay. Soundings reduced to OD (Malin). Superimposed numbering reflects the contouring from -6m OD to -1m OD. (From Hydrographic Surveys, 2018)

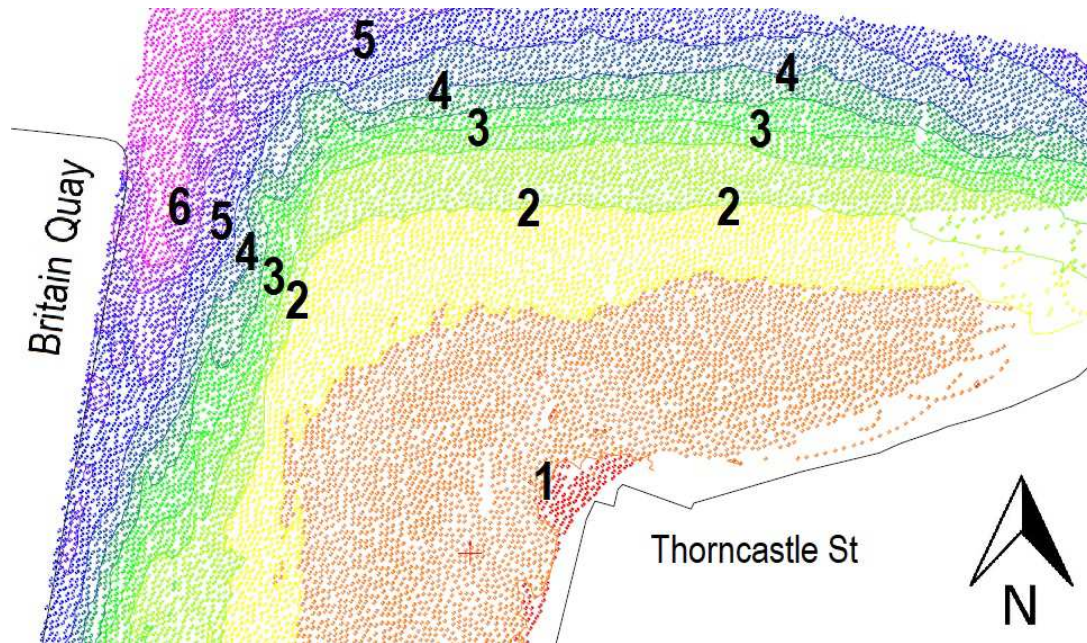

6.1.1.2 EASTERN ABUTMENT

(507, 508, 518)

- At the central abutment, river bed elevations measured between -1.18m OD to -1.47m OD at locations BH507, BH508 and BH/RC518. Location 518 was carried out in the event of the proposed bridge being re-orientated to align with Thorncastle Street. Both cable percussion and conventional rotary coring was undertaken sequentially at the same moonpool at BH/RC518. Otherwise separate moon pools were used with Geobore S coring employed at RC507 and RC508.
- As across all overwater holes, the overburden initially comprised very soft black organic SILT with frequent decaying plant debris, occasional fibres, hair, wood fragments, plastic and fabric. At 4.0m brb in BH507 (-5.46m OD), the silt became sandier, becoming very sandy from 6.0m brb (-7.46m OD). To a depth of 8.40m brb (-9.86m OD) in BH507, decaying plant debris, occasional fibres, hair, wood fragments, plastic and fabric continued to be found in the silt.
- In both 508 and 518, in contrast to the western abutment holes, at depth in the black SILT there was an absence of extraneous material such as plant debris / leaves, plastics, tin, rubber, timber and fabric. This may reflect the distance from active shipping channels or simply from Britain Quay / Grand Canal Locks where introduction of such material was

more likely. It could also suggest a historically shallower dredge depth in the area. The deepest foreign material found in 508 was at 2.0m brb (-3.18m OD) and, in BH518, was 5.50m brb (-6.97m OD).

- In BH508 and to a lesser extent in BH518, strata of GRAVEL were intercepted between the upper organic SILT and the lower glacial till. The existence of granular material here hints to the possible presence of small scale, braided higher energy channel deposits at the mouth of the Dodder. These were not found in the boreholes at the main abutment. It could be suggested that deep dredging may have removed such gravelly channels, with recent silts infilling the void. In BH508, beneath the black SILT, a 2.60m thick interval of loose clayey/silty very sandy GRAVEL, soft SILT and medium dense silty/clayey slightly sandy GRAVEL was found from 7.50m brb (-8.68m OD) to 10.10m brb (-11.28m OD). Elsewhere in BH518 a dense silty sandy GRAVEL was intercepted from 9.0m brb (-10.47m OD) to 9.70m brb (-11.17m OD).
- Very stiff glacial till was recorded at similar depths in both BH508 and BH518. The clay was logged at 10.10m brb (-11.28m OD) and 9.70m brb (-11.17m OD). These depths compare very well with the glacial till intercepted at the western abutment (-10.95m OD to -11.12m OD). The glacial till in BH507 was intercepted at 8.40m brb (-9.86m OD).
- Geobore S coring was used in both RC507 and RC508. Very stiff CLAY was noted to 15.60m brb (-17.27m OD) in the case of RC507. At this point a 'Possible Highly Weathered Rockhead' consisting of stiff grey black very gravelly CLAY with occasional cobbles of limestone was intercepted. Limestone rock was cored from 16.45m brb (-18.12m OD). A similar trend was reported in RC508 where possible weathered rockhead was reported at 15.80m (-17.10m OD) with limestone logged from 16.30m brb (-17.60m OD).
- Conventional coring in RC518 saw Symmetrix Openhole drilling through the base of the 8" cable percussion hole (10.50m brb). The hole proved CLAY to a depth of 13.20m (-14.67m OD). At this point a greyish brown clayey sandy GRAVEL was intercepted to 14.80m brb (-16.27m OD). The driller reported that this clayey sandy GRAVEL extended to weak Limestone rockhead at 14.80m (-16.27m OD), becoming strong to medium strong at 15.70m brb (-17.17m OD).

ACCESS UNDERPASS / LAND RECLAMATION / ST. PATRICK'S ROWING CLUB

(509, 510, 511, 512, 512A)

6.1.1.3 ACCESS UNDERPASS – 509 & 510

- The two locations closest to the South Wall are 509 and 510. They both align approximately on the underpass leading to the proposed St. Patrick's Boat Club. At the cable percussion exploratory hole locations, the river bed was measured at -1.14m OD and -1.28m OD. Geobore S coreholes were formed at both RC509 and RC510.
- Very soft black slightly sandy organic SILT was found at both holes. At BH509, to a depth of 1.0m brb (-2.14m OD), occasional plant debris (leaves), wood fragments, metal, paper and plastic were observed. There was also a weak hydrocarbon odour noted at this depth. At BH510, cloth fabric was found to a depth of 3.0m (-4.28m OD).
- In both BH509 and BH510, a strong hydrocarbon odour was recorded in the black slightly sandy SILT from 2.50m and 3.0m brb. The black SILT extended to 4.20m brb (-5.34m OD) in BH509 and to 6.0m brb (-7.28m OD). An oily lustre accompanied the odour in BH510.
- A medium dense slightly silty cobbly GRAVEL was intercepted in BH509 from 4.20m to 5.30m whereupon the glacial till was encountered. No gravel lenses were encountered in BH510. The till is noted at its highest elevation across the site in BH509 and BH510 at depths of 5.30m (-6.44m OD) and 6.0m brb (-7.28m OD).
- Geobore S coring revealed the continuation of very stiff CLAY to bedrock. Shy of rockhead, in both RC509 and RC510 there existed "Possible Highly Weathered Rockhead recovered as Stiff grey/black very gravelly CLAY with occasional cobble-sized fragments of limestone". Bedrock was cored from 17.35m brb (-18.59m OD) in RC509 and from 17.85m brb (-19.10m OD) in RC510.

6.1.1.4 LAND RECLAMATION / ST. PATRICK'S ROWING CLUB - 511, 512 & 512A

- BH511 sits on the western extremity of the proposed reclamation area. From river bed level (-1.84m OD) cable percussion boring intercepted a very soft black organic SILT containing frequent decaying plant debris / leaves, occasional wood fragments, fabric and plastic. A putrid odour was noted. This upper layer persisted to 1.50m (-3.34m OD) in BH511. A similar layer was reported in BH512 to 1.0m (-2.52m OD).
- Soft and very soft black slightly sandy SILT occasionally presenting a weak hydrocarbon odour was reported at depth in both holes. Ahead of very stiff till in BH512, a thin lense of medium dense clayey GRAVEL was met from 9.0 to 9.50m brb (-10.52 to -11.02m OD). Otherwise the silt continued to the underlying clay till. Solid stem augering at RC512A allowed the transition from soft SILT to stiff CLAY to be made.
- Glacial till was logged at elevations of -9.84m OD (8.0m brb) in BH511 and at -11.02m OD (9.50m brb) in BH512. RC512A reported stiff to very stiff CLAY at -10.14m OD (8.60m brb).
- Geobore S drilling in RC511 proved very stiff dark grey silty gravelly sandy CLAY to 16.44m brb (-18.19m OD). A thin band of possible weathered rockhead passed to fresh rockhead from 16.68m brb (-18.43m OD).
- RC512 was not extended beyond 13.50m brb (-15.04m OD). An 'unidentified obstruction' was supported by the presence of possible steel tracings recovered in the flush returns.

The possibility of there being tunnel infrastructure in the area led to the hole being terminated and relocated to the nearby RC512A.

- RC512A was Geobore S cored to a depth of 26.40m brb (-28.34m OD). The glacial till was reported from the base of the very soft black SILT at 8.30m brb (-10.24m OD). The clay became increasingly gravelly from 12.15m brb (-14.09m OD). The loss of core returns from 13.0m brb (-14.94m OD) to 14.65m brb (-16.59m OD) signaled the presence of granular non-cohesive deposits. CLAY returned completing the stratigraphy to eventual weathered rockhead at 15.40m brb (-17.34m OD). Fresh rockhead was reported from 15.80m brb (-17.74m OD).

Figure 16 – Core recovery in RC512A illustrating Till to Bedrock transition. Shown is the complete core run from 14.50-16.0m brb and part of the run from 16.0-18.50m brb. Weathered rockhead was reported from 15.40m brb with fresh core from 15.80m brb. Some gravel from the run 13.0-14.50m is apparent in the top of the 14.50-16.0m run.



BH504 / RC504 (drilled from jackup platform)	8.70m (-12.40m OD)	CP	Very soft black organic SILT with frequent leaves, rootlets & wooden twigs. Wooden fragments, cloth and plastic noted at 5.0m (-8.70m OD). Rare plastic noted in very soft black organic SILT from 6.0m to 7.0m. Hydrocarbon odour from 6.80m in dark grey black Silt. Glacial till from 7.40m (-11.10m OD).
		R (Conv)	Stiff to very stiff dark grey silty gravelly CLAY (Symmetrix openholing) from 8.45-15.35m brb. Driller reports weak, highly fractured rockhead at 15.35m with coring commencing at 16.45m (-19.08m OD). Due to non-intact nature, Symmetrix openholing again used from 18.75-19.55m (-22.18m OD) whereupon rock coring was recommenced in competent bedrock.
BH505 / RC505 (drilled from jackup platform)	10.50m (-12.15m OD)	CP	Very soft black slightly organic SILT with occasional decaying plant debris to 3.0m brb (-4.65m OD). Hydrocarbon odour noted. Very soft black slightly sandy SILT persists to 9.30m (-10.95m OD). Variable hydrocarbon odour, generally slight noted as strong from 7.50m. Glacial till from 9.30m
		R (GBS)	Geobore S coring from 9.10m (-10.70m OD) in stiff dark grey /black gravelly SILT becoming very stiff dark brown slightly sandy gravelly CLAY from 9.90 to 15.10m. 300mm thick lense of rounded GRAVEL from 13.60-13.90m. Interbedded LIMESTONE and MUDSTONE from 15.10m (-16.70m OD)
BH506 / RC506 (drilled from jackup platform)	10.20m (-12.10m OD)	CP	Very soft black slightly organic SILT with occasional to frequent plant debris to 3.0m brb (-4.90m OD). Hydrocarbon odour noted. Very soft black sandy SILT persists to 9.20m (-11.10m OD). Hydrocarbon odour noted as strong from 6.50m. Glacial till from 9.20m
		R (Conv)	From river bed, Symmetrix openholing in very soft black SILT with occasional waste/rubbish onto very stiff to stiff dark grey silty gravelly CLAY from 8.70m (-10.67m OD). Intercept rockhead at 16.20m with coring from 16.50m (-18.47m OD).

BH507 / RC507 (drilled from jackup platform)	9.70m (-11.16m OD)	CP	Very soft black SILT with frequent decaying plant debris, occasional fibres, hair, wood fragments, plastic and fabric to 4.0m (-5.46m OD). Slight hydrocarbon odour noted from 3.0 to 4.0m brb. Very soft black sandy SILT continued from 4.0 to 8.40m. Samples were notably very sandy from 6.0m. Stiff to very stiff grey to black CLAY till from 8.40m (-9.86m OD).
		R (GBS)	Auger used in uppermost blanket of soft SILT and into stiff to very stiff CLAY at 8.60m brb (-10.27m OD). Geobore S coring commenced from 9.30m in stiff / very stiff grey silty gravelly sandy cobbly CLAY. Possible weathered rockhead at 15.60m with bedrock coring from 16.45m (-18.12m OD).
BH508 / RC508 (drilled from jackup platform)	11.10m (-12.28m OD)	CP	Very soft black slightly organic SILT with frequent decaying plant debris / leaves, occasional timber, fabric and plastic to 2.0m (-3.18m OD). SILT continues from 2.0m brb without the anthropogenic content. Slight hydrocarbon odour noted from 4.50 to 5.50m. SILT becoming very sandy from 6.50m and passes into a (loose) clayey/silty very sandy GRAVEL from 7.50. A lower (medium dense) GRAVEL horizon is separated from this upper Gravel by a soft light grey SILT from 8.70 to 9.50m (-10.68m OD). Over-consolidated Till noted from 10.10m (-11.28m OD).
		R (GBS)	Auger used in soft black SILT penetrating the uppermost stiff dark grey CLAY at 9.0m brb (-10.30m OD). Geobore S coring commenced from 10.60m in stiff / very stiff grey silty gravelly sandy cobbly CLAY. Possible weathered rockhead at 15.80m with bedrock coring from 16.30m (-17.60m OD).

BH509 / RC509 (drilled from jackup platform)	6.50m (-7.64m OD)	CP	Very soft black slightly sandy organic SILT with occasional plant debris (leaves), wood fragments, metal, paper and plastic. Slight hydrocarbon odour noted in this upper layer. Soft black SILT continues to 2.50m (-3.64m OD) where a higher sand content is recorded. This corresponds with strong HC odour. At 4.20m (-5.34m OD) a medium dense slightly sandy silty cobbly GRAVEL was logged to 5.30m brb. Glacial till intercepted at 5.30m (-6.44m OD).
		R (Conv)	Auger used in soft black SILT to a depth of 5.60m brb (-6.84m OD) at which point stiff grey brown becoming dark grey brown slightly sandy gravelly CLAY was intercepted. Geobore S coring commenced from 6.50m in the glacial till. Possible weathered rockhead at 15.90m passed into more competent bedrock from 17.35m (-18.59m OD).
BH510 / RC510 (drilled from jackup platform)	7.90m (-9.18m OD)	CP	Very soft black slightly organic SILT with occasional decaying plant debris, rubber, metal and plastic. Putrid odour noted. Soft black SILT with rare sand laminae and plant debris, fabric and wood to 3.0m. Occasional oily lustre noted from 3.0m to 6.0m (-7.28m OD). Glacial Till comprising stiff to very stiff dark grey to greenish grey CLAY from 6.0m.
		R (GBS)	Augering of soft black SILT to a depth of 8.0m brb (-9.25m OD) directly onto stiff to very stiff dark grey silty sandy gravelly CLAY. Geobore S coring commenced from 8.30m in these cohesive glacial deposits. Possible weathered rockhead met at 17.30m passing into more competent bedrock from 17.35m (-18.59m OD).

BH511 / RC511 (drilled from jackup platform)	9.0m (-10.84m OD)	CP	Very soft black very sandy SILT with occasional rope and plastic to 3.50m (-13.03m OD), with loose black very silty SAND to 10.50m (-20.03m OD). Sand becoming Medium dense to 12.0m (-21.53m OD). Coarse GRAVEL with cobbles to 13.70m (-23.23m OD).
		R (GBS)	Augered soft black SILT to 7.80m brb (-9.55m OD) passing to stiff to very stiff dark grey silty sandy gravelly CLAY. Geobore S coring of the CLAY commenced from 8.50m. Possible weathered rockhead met at 16.44m passing into more competent bedrock from 16.68m (-18.43m OD).
BH512 / RC512 (drilled from jackup platform)	10.50m (-12.02m OD)	CP	Very soft black slightly organic SILT with frequent decaying plant debris / leaves, occasional wood fragments, fabric and plastic. Putrid odour noted. Soft and very soft black slightly sandy SILT to 9.0m brb (-10.52m OD). Slight hydrocarbon odour from 2.0m to 4.0m. Thin bed (500mm) of medium dense clayey GRAVEL precedes very stiff black CLAY at 9.50m (-11.02m OD).
		R (GBS)	Slightly putrid very soft black SILT removed by auger to 8.40m brb (-9.94m OD) followed by Geobore S coring of an underlying thin band of soft dark grey slightly sandy SILT, also slightly putrid. Coring continued through to the underlying very stiff CLAY from 8.60m (-10.14m OD). Hole terminated prematurely at 13.50m in CLAY (-15.04m OD)
RC512A (drilled from jackup platform)	No CP	R (GBS)	Slightly putrid very soft SILT overlying soft black occasionally grey slightly sandy SILT with slight HC odour. Augering penetrated to stiff dark grey very sandy gravelly CLAY from 7.50m (-9.44m OD). Geobore S coring commenced in this very stiff CLAY from 8.30m brb, encountering sandy GRAVEL from 13.0-14.65m. CLAY then once again cored to eventual rockhead at 15.80m (-17.74m OD)

BH518 / RC518 (drilled from jackup platform – rotary coring followed on through open CP hole from 10.50m brb)	10.50m (-11.97m OD)	-----	CP	Very soft black slightly sandy SILT with frequent plant debris and a slight hydrocarbon odour from river bed to 1.0m brb (-2.47m OD). Very soft black sandy SILT persists to 3.50m. Plant debris, occasional plastic, tin and rubber noted from 3.50m to 5.50m. Very soft very sandy SILT continues from 5.50m to 9.0m (-10.47m OD). As with BH512, basal silty sandy GRAVEL ahead of Till. Gravel bears strong HC odour. Glacial Till from 9.70m (-11.17m OD).
		30.20m (-31.67m OD)	R (GBS)	Symmetrix openholing used to extend hole from 10.50m (-11.97m OD). Very stiff dark grey black sandy gravelly CLAY reported by driller from 10.50-13.20m (-14.67m OD). Further openholing proved greyish brown clayey sandy GRAVEL to 14.80m. Driller observed rockhead from 14.80m coring from 15.70m (-17.17m OD)

Key

- CP = Cable Percussion Boring
- R_(Conv) = Rotary Conventional Coring
- R_(GBS) = Geobore S Coring

The cross sections / ground models entitled 'North Alignment' and 'South Alignment' (refer to Appendix 2) illustrate the ground profile or stratigraphy from west to east across the River Dodder. The rockhead profile can be seen to be particularly uniform across the channel with a consistent thickness of glacial cover overlying the bedrock. The alluvial deposits vary in their thickness, being scoured from the record adjacent to Britain Quay (See Figure 15).

6.1.2 Land Ground Conditions

Works on land comprised the construction of both boreholes and coreholes with inspection pits, trial pits and slit trenches performed at locations across each area. Dynamic probes were conducted alongside the quay wall at Britain Quay in a bid to discern its subsurface structure, and window samples were acquired to assist with the Contamination Assessment Report [CAR] being compiled by O’Callaghan Moran & Associates. The ground conditions encountered on both the western and eastern side of the River Dodder are discussed separately in this section.

6.1.2.1 EASTERN BANK in proximity to TOM CLARKE BRIDGE & ST. PATRICK’S ROWING CLUB
 (Exploratory boreholes / coreholes 515, 515A, 516, 516A, 516B & 517 in addition to trial pit 602 and slit trenches 2, 2A, 2B, 3, 4 & 5)

- The majority of exploratory hole locations were conducted on the grassed area between Tom Clarke Bridge and Thorncastle Street. The area houses the shaft for the Liffey Services Tunnel which extends northwest, under the Liffey, towards North Wall Quay. Coupled with the service tunnel, a high-pressure gas main also leaves the same shaft headed due north for North Wall Quay. A number of slit trenches were excavated in the area, some under the direction of GNI officials, in an attempt to locate high-pressure mains servicing the tunnels.

Figure 17 - Works on land east of the River Dodder (Taken from Appendix 1)

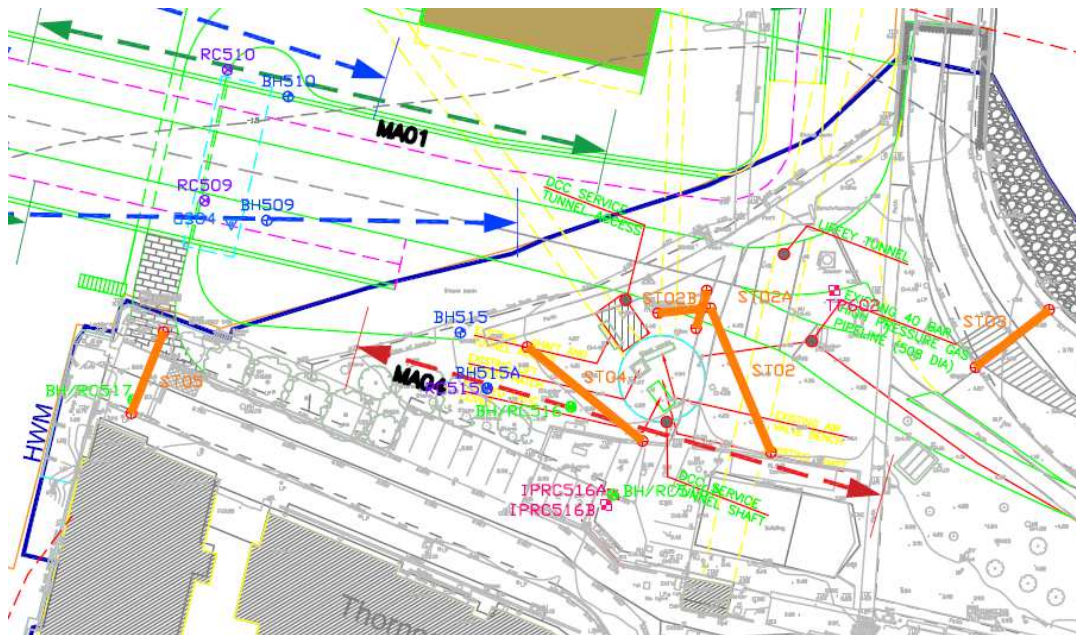

- Shallow excavations on the aforementioned grassed area showed a thin Topsoil cover, typically 0.10m, underlain by a thick accumulation of Made Ground of varying composition. The Made Ground was found to comprise a mix of soft, firm and stiff (compacted) gravelly CLAY with cobbles, boulders, brick, concrete, timber, plastic, leather, ceramics and on occasion, in BH515A, what is remarked as an ‘asbestos pipe’. This build up of differing Made Ground is thought to date from the construction of Tom Clarke Bridge, the then East Link Bridge. Photographs available online (Figures 18A, 18B & 18C) suggest construction and demolition waste was used to build up the area immediately north of the South Quay Wall to construct the bridge tie-in.

Figure 18 – Made Ground on southern approach pictured during bridge construction, dated 1983 (Bridges of Dublin, n.d.) - *Fig 18A* Made Ground comprising predominantly brown CLAY mixed with steel re-bar, limestone boulders and rare steel bar. ***Fig 18B*** View north of South abutment cofferdam from Thorncastle Street. Limestone and concrete can be seen in the clay matrix. ***Fig 18C*** View from Liffey back towards Thorncastle Street and O’Rahilly House Flats. Tipped, boulder-sized concrete rubble noted at water level in foreground.



Fig 18A



Fig 18B



Fig 18C

- Slit trench ST03 constructed on the R131 Regional Road on the southern approach to Tom Clarke Bridge reported extensive angular boulders ranging in depth from 0.30m to 1.0m bgl. This ties in well with the imported material pictured in Figure 18. Likewise, slit trenches on the grassed area generally progressed no greater than 1.0m due to boulder obstructions – the exception to this being in trenches in proximity to the recently installed GNI gas main whose crown was unearthed at 2.0m and 2.30m in both ST02 and ST02A.
- BH515, carried out near the north west-facing rock armour, met a similar fate as nearby exploratory holes. The borehole was terminated at 2.0m (1.56m OD) on a boulder obstruction. Similarly, BH516 and BH516A intercepted obstructions at 1.0m (2.98m OD) and 0.80m depth (2.42m OD) respectively. No cable percussion boreholes constructed on the grassed area met natural ground. Depths achieved ranged between 0.80 and 5.20m.
- East of the River Dodder, only one cable percussion borehole, BH517, was positioned off the main grassed area. Following an inspection pit to 1.30m bgl (1.447m OD) in which was encountered Made Ground of gravelly CLAY, brick, bone and ash, the borehole log shows Made Ground persisting to 4.30m bgl (-1.55m OD). It was described as layers of brown very clayey silty GRAVEL underlain by grey sandy gravelly SILT with occasional cobbles and finally grey brown very sandy silty GRAVEL. At 4.30m, indigenous soil comprising a very soft to soft grey very sandy slightly gravelly cobbly SILT was met underlain by a thick accumulation of very soft grey brown very sandy SILT with organic fibres. Following this, at 13.10m bgl (-10.35m OD), a thin band of medium dense grey brown sandy silty GRAVEL was intercepted ahead of very stiff (hard) sandy gravelly CLAY. The bore was terminated in this very stiff stratum at 14.50m bgl. Symmetrix openholing later proved rock beneath the CLAY at 23.10m (-20.35m OD), with weathered rock reported from 21.50m (-18.75m OD).
- BH515A, on the grassed area, extended to 5.20m bgl (-1.48m OD) terminating in black silty GRAVEL with cobbles, boulders, brick, concrete, timber, plastic, leather, ceramics & asbestos pipe fragments. Follow-on Symmetrix openhole drilling (RC515) established a base to Made Ground at 6.0m bgl (-2.28m OD). At this point loose grey silty SAND with shell fragments was proven to 10.20m bgl (-6.48m OD). A thick sequence of stiff grey silty gravelly CLAY extended from beneath the SAND to 19.70m bgl (-15.98m OD). Further Symmetrix drilling pushed the drillhole deeper through what was termed by the driller as “weak black weathered ROCK” to eventual cored bedrock from 23.10m (-19.38m OD).
- RC516 encountered an obstruction at 2.10m and given the potential for buried services in the area, it was thought that a new location should be explored. For this reason, two additional inspection pits were excavated south of the main grassed area. These were labelled IPRC516A and B and were positioned on the roadway directly west of St Patrick’s Rowing Club. Shallow obstruction was again met in IPRC516B and so the rotary corehole was constructed through IPRC516A.
- RC516A confirmed Made Ground to a depth of 6.20m bgl (-2.98m OD). Possible granite quay wall was drilled through from 5.10m to 6.20m (See Fig 19A). Immediately beneath the granite, RC516A intercepted natural loose grey/brown silty gravelly SAND with fragments of shell from 6.20m to 7.30m (-4.08m OD). This in turn passed to loose grey/brown silty SAND with fragments of shell to a depth of 10.80m (-7.58m OD). Further Symmetrix openhole drilling proved firstly firm grey silty sandy gravelly CLAY and then very stiff dark grey black silty gravelly cobbly CLAY. The CLAY was remarked as becoming increasingly gravelly at 18.70m (-15.48m OD) eventually passing into what was described as the driller as returns of “weak black weathered ROCK” from 21.40m (-18.18m OD). Rock was cored from 24.50m (-21.28m OD). The levels tally well with the observations made during the excavation of the nearby Liffey Tunnel Southern Shaft (listed in Table 1) (See Fig 19B).

Figure 19A & 19B – Historic location of South Quay Wall at Thorncastle Street Fig 19A RC516A location superimposed on 1888 - 1913 Ordnance Survey Ireland 25 inch survey. **Fig 19B** Location of Southern Shaft of Liffey Tunnel as shown in Corporation of Dublin ‘Liffey Tunnel and Shafts - Site Plan’.

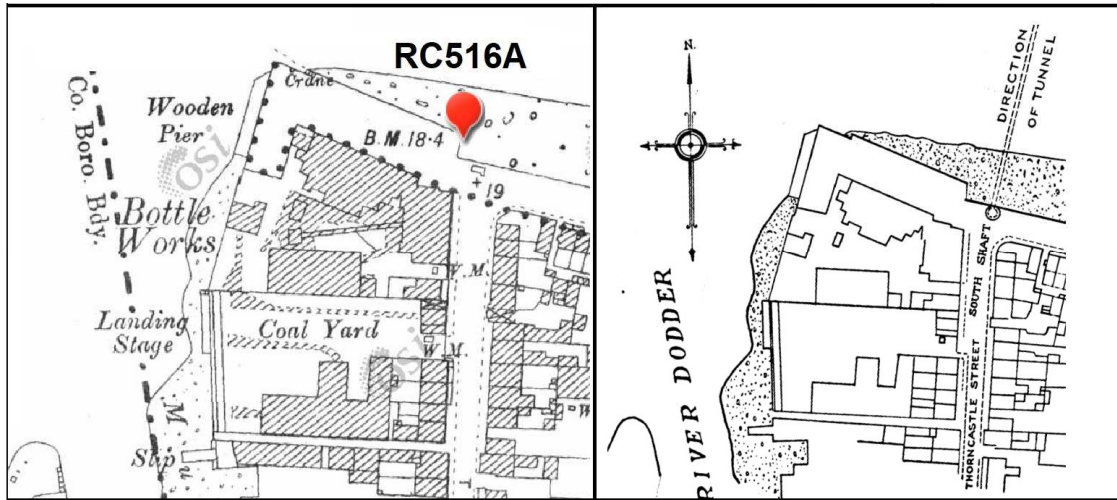

Fig 19A reproduced from OSI website (www.osi.ie)
 Ordnance Survey Ireland Licence No. EN 0070019
 © Ordnance Survey Ireland / Government of Ireland
 Fig 19B reproduced from Corporation of Dublin (n.d.)

Table 5 - Exploratory Hole Locations east of the River Dodder

Trial Pits	Slit Trench	Inspection Pits	Cable Percussion Boreholes	Rotary Coreholes
TP602	ST02	IPBH515	BH515	RC515
	ST02A	IPBH517	BH515A	RC516
	ST02B	IPRC516A	BH516	RC516A
	ST03	IPRC516B	BH516A	RC517
	ST04		BH517	
	ST05			

6.1.2.2 WESTERN BANK / BRITAIN QUAY

(Exploratory bore / coreholes 501 & 502, trial pit 601, slit trench 1 and DP 601-604 and WS01, WS02 and WS03)

- The exploratory holes conducted on Britain Quay (west of the River Dodder) were carried out in a later phase of works, separate to the main tranche of SI works. This was due to access issues resulting from contemporaneous construction works at Capital Dock and the positioning of Sisk contractor cabins over the location of the proposed exploratory holes. At the time of investigation (August 2019), with the containers having been removed and area reinstated, the quayside was found to be landscaped with a thin cover of Topsoil (0.10 to 0.20m thick). This cover was observed at all test locations. A thin layer of what is assumed

to be horticultural SAND was found beneath the Topsoil and this was recorded in both window sample holes, the ST01 log and the log for TP601.

- FILL extended beneath the placed Sand with imported angular GRAVEL (possible cl.804 type material) noted in WS1, WS2 and WS3 to a depth of 0.80m bgl. In ST01, from 0.45m to 0.60m, similar granular fill was logged. It was recorded that a layer of geotextile membrane was present directly beneath the gravel. It is assumed the geotextile was placed as a separator layer during the most recent works at Capital Dock.
- Beneath the geotextile, MADE GROUND logged in both pits and bores was described variably as grey silty sandy gravelly CLAY with red brick and concrete fragments (BH501), fine to medium grey black and grey silty SAND (ST01, WS1 & WS2) and grey silty sandy GRAVEL (BH02). ST01 terminated at 1.80m (approx. 1.60m OD) in what was described as firm grey black sandy SILT. Window samples extended to 3.0m depth (equivalent of 0.53, 0.64 and 0.70m OD) each reporting soft to firm grey black sandy organic SILT (MADE GROUND) to their respective bases.
- In the southernmost of the two deep bores on Britain Quay, BH501 intercepted loose to medium dense grey sandy silty cobbly GRAVEL from 4.0m (-0.68m OD). This was labelled as "Possible MADE GROUND". It was underlain by a firm grey sandy gravelly silty cobbly CLAY. Although not remarked as such in the log, this may also be Made Ground. At its base, at a depth of 9.0m (-5.68m OD), a very soft grey slightly sandy SILT was encountered. This is typical of the type of stratum found in the river bed in each of the overwater holes. Similar to the findings in the overwater holes, it is underlain by a medium dense grey sandy clayey very cobbly GRAVEL (at 13.0m or -9.68m OD) and in turn by a very stiff / hard grey sandy gravelly CLAY (at 15.0m or -11.68m OD).
- Symmetrix openholing performed by the rotary coring rig further penetrated the uniformly very stiff CLAY deposits found at the base of BH01 from a depth of 16.0m to 22.50m bgl (-19.18m OD). At this point, conventional coring was undertaken recovering strong and medium strong dark grey black muddy Limestone and interbedded weak Mudstone typical of the Dublin Calp Formation.
- Positioned almost 13m north of BH501 on Britain Quay, the boring log for BH502 reports Made Ground extending to a depth of 8.0m bgl (-4.56m OD). This consists of grey sandy GRAVEL with lenses of grey silt from 4.0m bgl. A loose grey silty SAND was intercepted beyond 8m. This may signify formerly dredged material (Made Ground) or could represent the indigenous strand deposits prior to reclamation. The sand persists for 2m where it is underlain by a very soft grey SILT similar to that found in the mouth of the River Dodder. Due to recurring 'blowing sands', the borehole was terminated at 13.0m depth bgl (-9.56m OD).
- Following termination of BH02 in what were termed 'blowing sands', Symmetrix openholing from 13.0m confirmed the base of the sand at 13.50m bgl (-10.06m OD). Sandy GRAVEL was then recorded from drilling returns. This persisted to 19.50m (-16.06m OD). A probable highly weathered Rock with clay layers, recovered as 'clayey sandy GRAVEL', was cored from 19.50m. Bedrock cores were recovered from 21.0m bgl (-17.56m OD). This depth to rock marries well with levels found in nearby overwater holes RC503 and RC504 (-17.34m OD & -17.98m OD)

Table 6 - Exploratory Hole Locations located west of the River Dodder

Trial Pits	Slit Trench	Window Samples	Dynamic Probedholes	Cable Percussion / Rotary Coreholes
TP601	ST01	WS1	DP601	BH/RC501
		WS2	DP602	BH/RC502
		WS3	DP603	
			DP604	

Figure 20 – Made Ground / Fill Profile with underlying Silts in Slit Trench ST01 - Fig 20A Made Ground comprising Topsoil over Sand and granular FILL onto geotextile membrane at 0.60m. Fine to medium grey black silty SAND logged from 0.60m to 1.0m bgl. **Fig 20B** Firm grey black sandy SILT in base of trench from 1.0 to 1.80m. Possible former window sample hole in trench base.



Fig 20A



Fig 20B

6.2 Made Ground

The stratigraphy proven on the western bank of the River Dodder attests to the centuries-old quay wall development allied with the former 19th and early to mid-20th century workings on Britain Quay and Sir John Rogerson’s Quay. To this effect, significant thicknesses of Made Ground are found on the west bank of the Dodder extending from behind the quay walls.

On the eastern banks of the Dodder, the old South Quay wall is generally masked behind the relatively recent Made Ground infill which was used to form the approach road to the East Link Bridge built in the early 1980’s. It is assumed from photographs taken during the construction that the material used to reclaim the southern shore was a mixture of construction and demolition waste (See Figure 18).

Table 7 - Thickness of Made Ground established in drillholes, boreholes, trial pits, slit trenches and window samples. Bold font denotes actual base of Made Ground.

BH / RC / WS / TP No.	Made Ground Thickness (m)	Possible Base of Made Ground m bgl (m OD)
Britain Quay (West of R. Dodder)		
BH/RC501	9.0	9.0 (-5.68)
BH/RC502	8.0	8.0 (-4.56)
WS1	3.0 ⁱⁱ	3.0 ⁱⁱ (0.53)
WS2	3.0 ⁱⁱ	3.0 ⁱⁱ (0.70)
WS3	3.0 ⁱⁱ	3.0 ⁱⁱ (0.64)
ST01	1.80 ⁱⁱ	1.80 ⁱⁱ (1.60)
TP601	2.40 ⁱⁱ	2.40 ⁱⁱ (0.85)
Eastern Bank – North of Old South Quay Wall (East of R. Dodder)		
BH515	2.0 ⁱ	2.0 ⁱ (1.56)
BH515A/RC515	6.0	6.0 (-2.28)
BH516	1.0 ⁱ	1.0 ⁱ (2.98)
BH516A	0.80 ⁱ	0.80 ⁱ (2.42)
RC516	2.10 ⁱ	2.10 ⁱ (1.88)
ST02	2.20 ⁱⁱ	2.20 ⁱⁱ (2.0)
ST02A	2.50 ⁱⁱ	2.50 ⁱⁱ (2.0)
ST02B	1.20 ⁱⁱ	1.20 ⁱⁱ (3.20)
ST03	1.0 ⁱⁱ	1.0 ⁱⁱ (3.0)
ST04	1.30 ⁱⁱ	1.30 ⁱⁱ (2.60)
TP602	0.70 ⁱⁱ	0.70 ⁱⁱ (3.62)
Eastern Bank – South of Old South Quay Wall (East of R. Dodder)		
BH517	4.30	4.30 (-1.55)
RC517	3.50	3.50 (-0.75)
ST05	1.30 ⁱⁱ	1.30 ⁱⁱ (1.40)
RC516A	6.20	6.20 (-2.98)
IPRC516B	0.26 ⁱⁱ	0.26 ⁱⁱ (2.93)

ⁱ = Exploratory hole terminated on obstruction

ⁱⁱ = Extent of dig in trenching / sample drive in window sampling

Made Ground on the western side of the R. Dodder at Britain Quay typically comprises loose / medium dense grey sands, gravels and clay/silt. Both BH501 and BH502 indicate the presence of 8.0 to 9.0m of Made Ground (-5.68 to -4.56m OD). The makeup of the material could be assumed to be largely that of a dredged material. Only in the uppermost strata (0 - 4.0m in BH501) is foreign debris such as red brick and concrete noted. For the most part, such anthropogenically-derived material is largely absent. The silt from c. 1.0m depth is noted as organic in each of WS1, WS2 and

WS3. The SPT values obtained from in-situ testing in the Made Ground highlight the loose / soft nature of the Made Ground (Figure 21).

Figure 21 – SPT data plot Vs depth for Made Ground strata in Land Boreholes

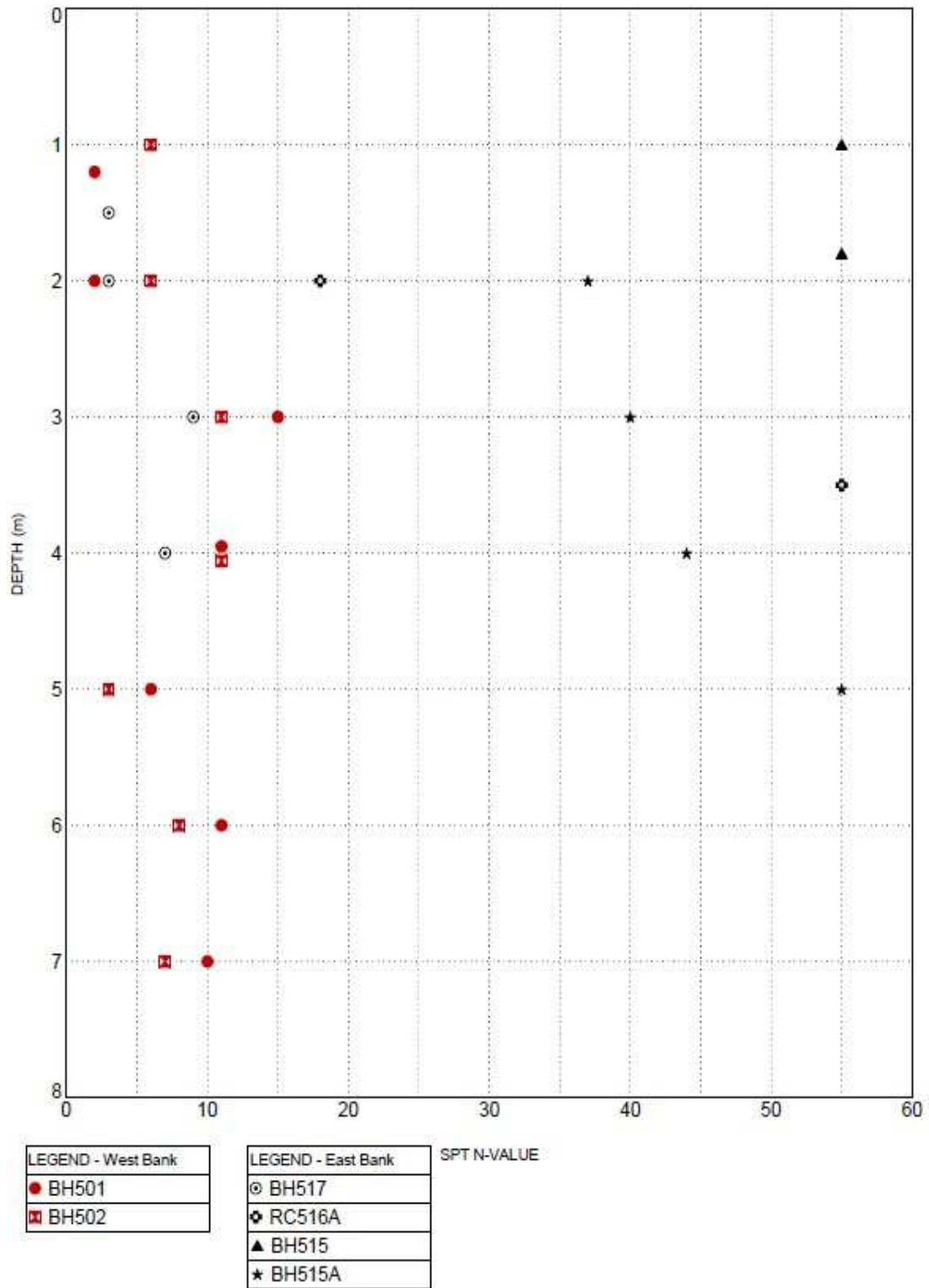

On the eastern side of the River Dodder, the thickness of Made Ground was only observed in one exploratory hole (RC515.). Such was the boulder or clast dominant extent of Made Ground, the

thickness of Made Ground could not be assessed in other holes. In RC515, the base of Made Ground material was measured at 6.0m depth. The Made Ground consisted of a mix of grey brown gravelly CLAY and silty GRAVEL with cobbles, boulders, brick, concrete, timber, plastic, leather, ceramics & rare asbestos pipe fragments. Boulders, both concrete and limestone, were noted in many excavated trenches, and are thought to be accountable for the high SPT N-value blow counts and number of shallow SPT refusals in cable percussion boreholes (Figure 21).

6.3 Alluvial Deposits

Underlying a cover of Made Ground are very soft to soft alluvial and marine sediments. These were found on both eastern and western river banks and most especially as thick accumulations in the overwater holes. The very soft silts, occasionally organic can act as a marker horizon across the mouth of the R. Dodder signaling the transition to natural ground. Occasionally, due to former dredging and, along Britain Quay, scouring of the river channel, the thickness of Silts is reduced.

The majority of boreholes (both land- and river-based), revealed thick sequences of very soft and soft silt, clay and silty fine sand. In an effort to classify the inherent strength of these soils in-situ shear vane tests were undertaken (See Table 8). In each case the Geonor H-70 shear vane apparatus was pushed into undisturbed soil with peak and re-moulded shear strengths recorded. The results are also shown on the engineering logs in Appendices 1 and 2 of the factual report. Piston sampling in addition to U100 driven sampling was performed in the alluvial soils. Piston sampling is best suited to recovering very soft fine grained or cohesive soils in an undisturbed state. Standard Penetration Testing [SPT] generally proved ineffective in assessing shear strength with the rods commonly falling under self-weight. Figure 23A and 23B include plots of SPT N-Values relative to depth for the alluvium.

Figure 22 - Quaternary Geology of Ireland, Sediments Map for Dublin City / South Dublin showing the site (marked red and white circle)

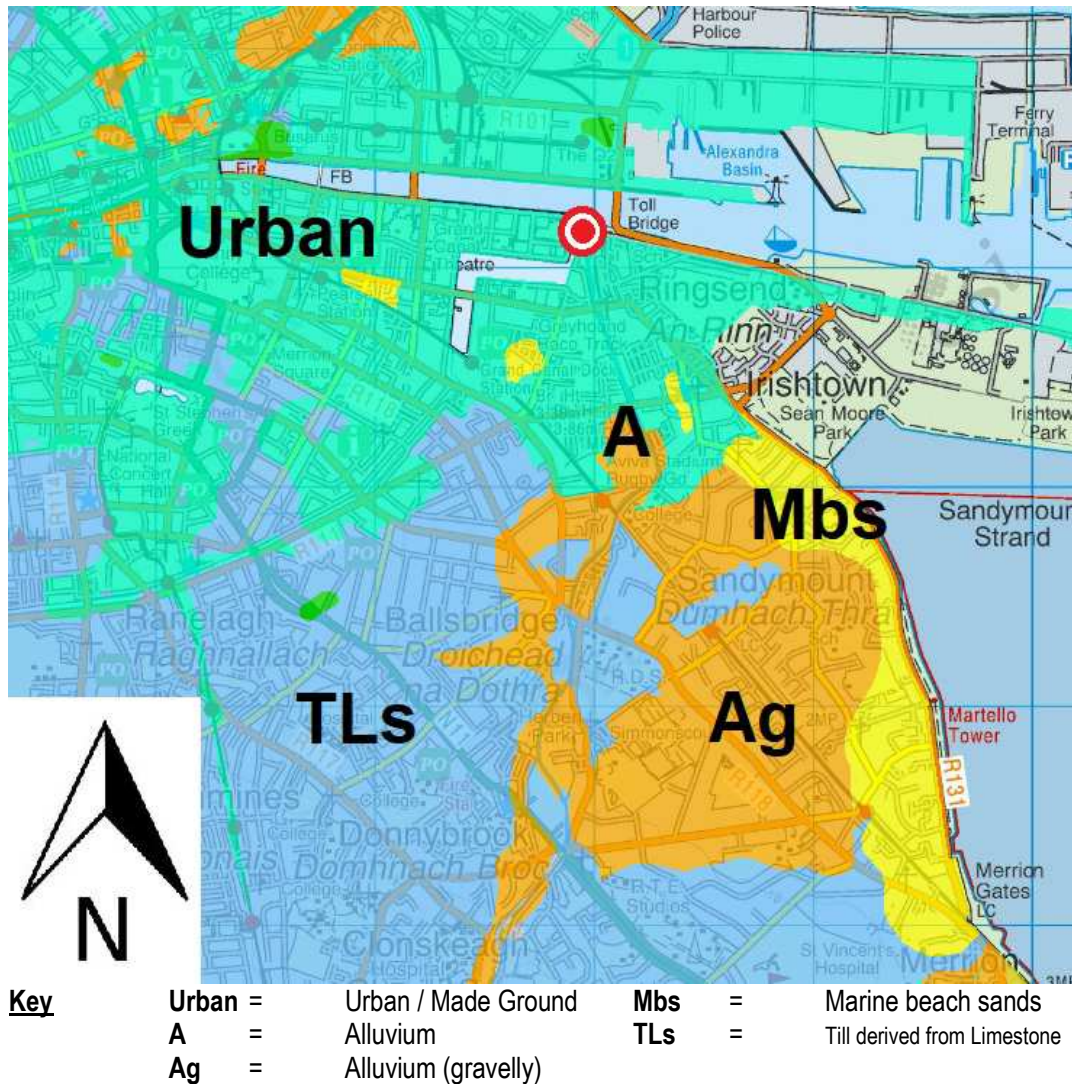

Table 8 - Summary Details of In-situ Vane Testing in Exploratory Boreholes

BH No.	Test Depth (m bgl)	Peak Shear Strength (kN/m ²)	Remoulded Result (kN/m ²)
BH503	1.0	0.0	0.0
BH503	2.0	2.0	0.0
BH503	6.50	6.0	0.0
BH504	6.0	4.0	0.0
BH504	0.50	0.0	0.0
BH505	1.0	2.0	0.0
BH505	4.0	3.0	0.0
BH505	6.50	5.0	0.0
BH506	3.0	3.0	0.0
BH506	6.0	4.0	0.0
BH506	2.0	3.0	0.0
BH506	8.0	9.0	1.0
BH507	4.50	5.0	0.0
BH507	7.50	11.0	1.0
BH508	2.0	3.0	0.0
BH508	4.50	8.0	1.0
BH509	2.0	5.0	0.0
BH509	1.0	2.0	0.0
BH509	4.0	3.0	0.0
BH510	1.50	5.0	0.0
BH510	5.0	2.0	0.0
BH511	2.0	5.0	0.0
BH511	5.0	3.0	0.0
BH512	4.0	3.0	0.0
BH512	6.50	4.0	0.0
BH518	1.50	3.0	0.0
BH518	5.0	7.0	0.0
BH518	7.50	7.0	0.0

The undrained shear strength (S_u) of the fine-grained alluvial deposits are demonstrated by the relatively consistent values recorded from in-situ vane testing (refer to Table 8). These established undrained shear strengths (S_u) mostly ranging from 3 to 11 kN/m² to depths of up to 7.50m. The majority of the in-situ vane tests suggest the alluvial soils have very low (10 to 20 kN/m²) shear strengths. In terms of consistency (EN 14688-1:2002), the alluvial soils are categorized as very soft or soft.

Furthermore, the 'SPT N-Value v Depth' plots (Figure 23A & 23B) clearly demonstrate the soft (rarely with depth progressively soft to firm) nature of the deposits. The overwater SPT results are plotted separately to those obtained from the land-based holes. The land-based boreholes produced slightly higher N-Values, thought to be reflective of the surcharging effect of the overlying Made Ground / fill material.

Figure 23A – SPT data plot Vs depth for Alluvium / Marine Beach Sands strata in Land Boreholes

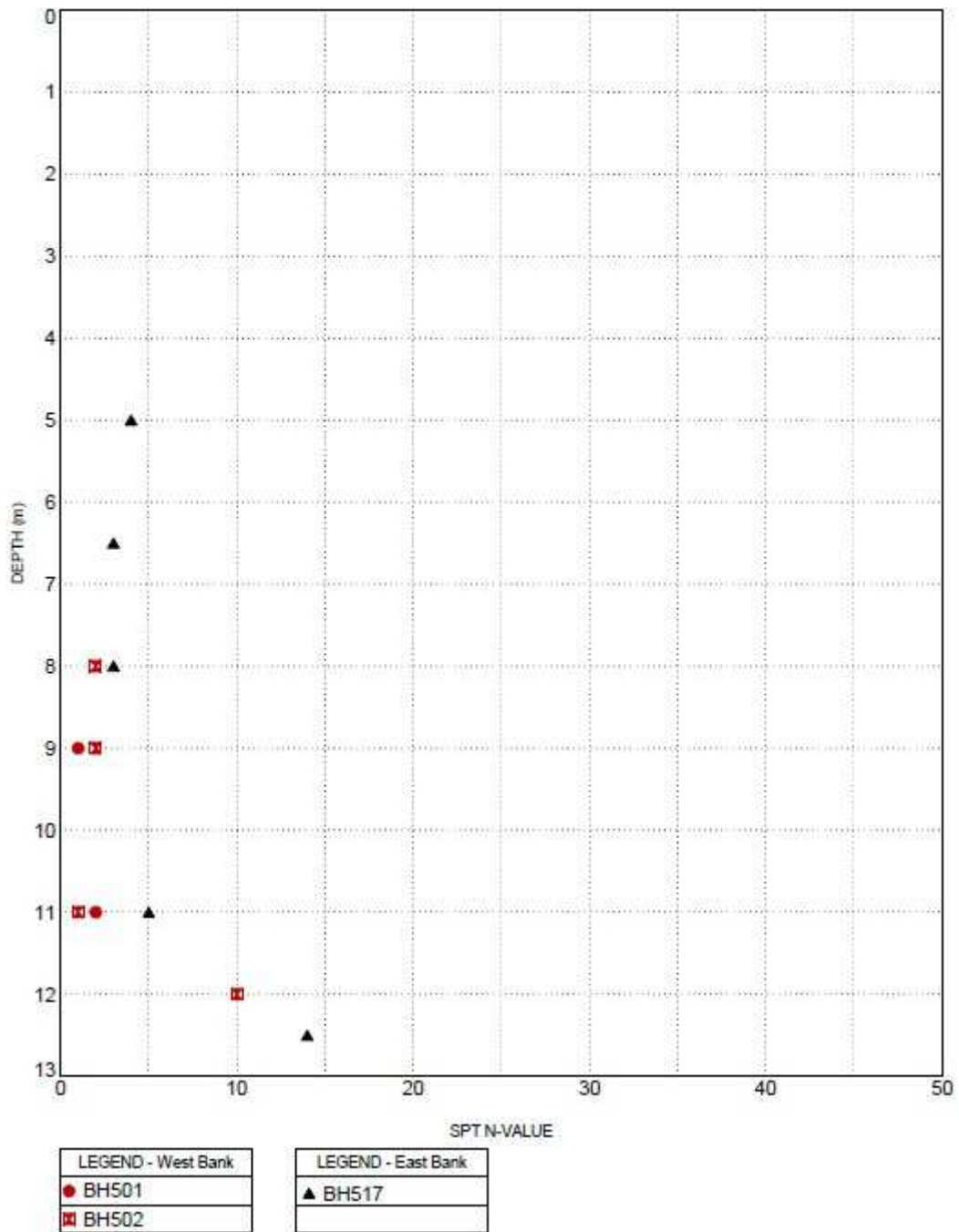
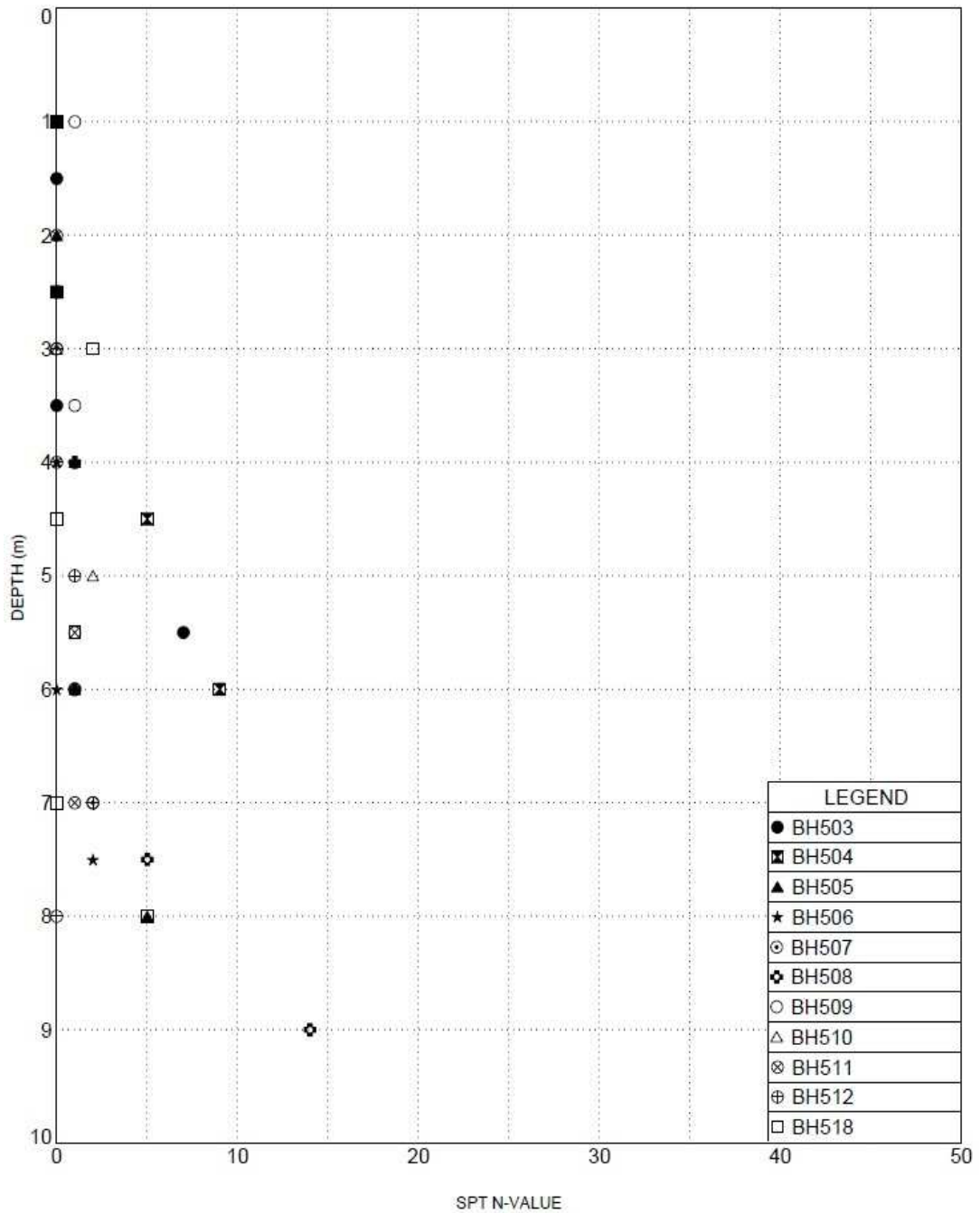
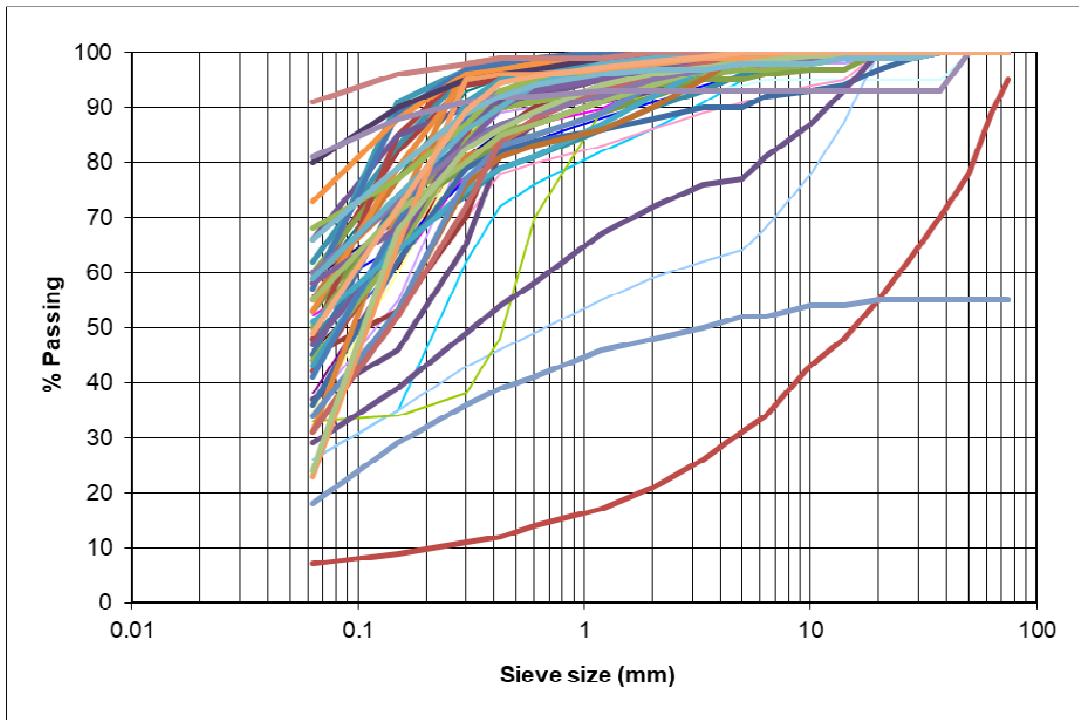

Figure 23B – SPT data plot Vs depth for Alluvium strata in Overwater Boreholes



A number of particle size gradings, moisture contents and Liquid / Plastic Limit tests (Atterberg Limit) were performed on the alluvial samples. The test samples also included rare higher energy, interbedded fluvial sediments such as silty sands and thin gravels. A grading envelope has been prepared for the samples tested and is presented in Figure 24. This illustrates the uniformly high percentage of fines-dominant samples and conversely the low proportion of coarse fraction sizes, cobbles, gravels, etc., within the sampled deposits. Samples with an elevated sand and gravel fraction were restricted to less than 5 of the 60 samples sieved. On the whole, the particle size distributions show the fine sediments contain a high proportion of 0.1 to 0.5mm size constituents. Moisture contents were found to range from 31 to 124%. The higher-end moisture contents highlight the variable organic matter content (11% LOI in BH511 at 2.0m where 124% MC was recorded).

Figure 24 - Grading Envelope for Alluvial Sediments found in Cable Percussion boreholes including undifferentiated fluvial deposits



Liquid and Plastic Limit tests (Atterberg Limits or consistency indices) were determined on the <425 micron fraction. Figure 25 shows the fine-grained alluvial soils are comprehensively non-plastic silts lying to the right of the A-line. In general, Liquid Limits typically range between 40 and 60% in both land and river-based samples. The non-plastic behaviour is in good agreement with the sample visual descriptors.

Figure 25 – Atterberg Limit Plot (Alluvial Sediments)

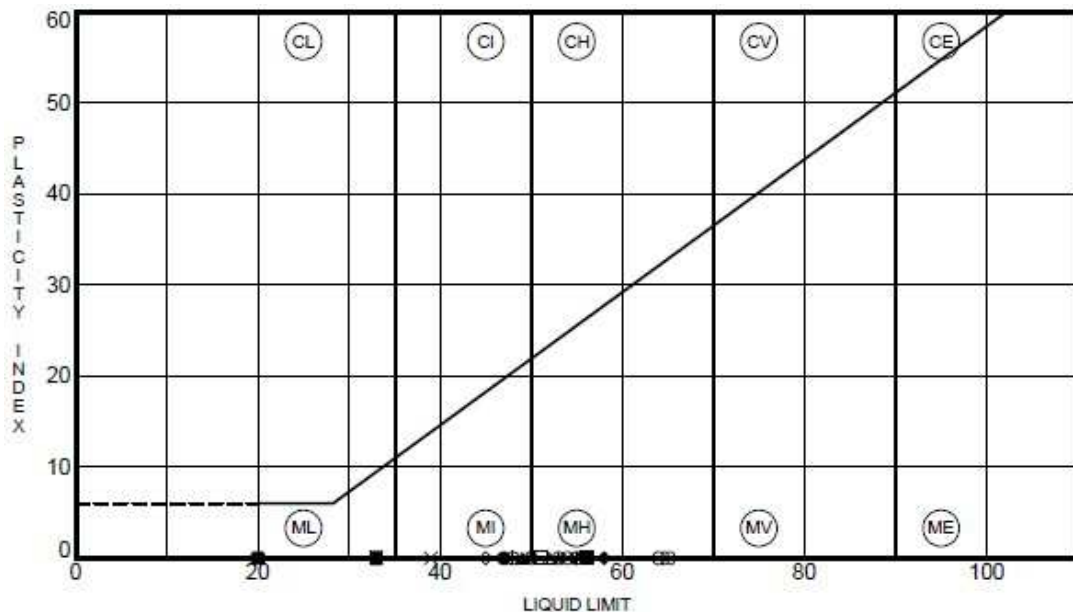

Triaxial compression and one-dimensional consolidation (oedometer) tests were undertaken on selected alluvial soil samples (Piston and U100's). The tests were performed to measure undrained shear strength, coefficient of volume compressibility (M_v) and coefficient of consolidation (C_v). The triaxial test results are summarized in Table 9 with the consolidation test findings summarised in Table 10. Inspection of the data in Table 9 shows the undrained shear strengths (S_u) ranging from as low as 11 to 22 kN/m². The aforementioned range of undrained shear strengths measured in the triaxial cell shows the alluvial soils vary from very low shear strength (S_u 10-20 kN/m²) to low strength (20 to 40 kN/m²) as defined by Table 9 in BS 5930 (2015) and Table 5 in EN 14688-2:2004.

Table 9 - Summary Details of Triaxial Tests on Alluvial Soils

BH No.	Sample Depth (m)	Moisture Content (%)	Cell Pressure (kN/m ²)	Undrained Shear Strength (S_u) kN/m ²
BH501	10.0	41	100	22
BH501	12.0	44	120	18
BH502	10.0	42	100	11
BH517	7.0	44	70	16
BH517	9.0	39	90	22
BH517	11.50	28	115	21

The oedometer tests produced coefficients of volume compressibility (M_v) in the range 0.142 to 4.3 m²/MN. Overall, the alluvial soils are classed as medium compressibility (M_v 0.10 to 0.30 m²/MN) to locally very high compressibility (M_v >1.50 m²/MN) as defined in Table 2.11 of Tomlinson's Foundation Design & Construction, 7th Ed. The soils which were identified as 'highly compressible' pertain to the samples recovered and tested from the overwater boreholes. The highly compressible nature of the alluvial soils correlates well with undrained shear strength and the visual strength descriptors.

Table 10 - Summary Details of Consolidation Tests on Alluvial Soils

Exploratory Hole	Sample Depth (m bgl)	Moisture Content (%)	M_v (m ² /MN)	C_v (m ² /yr)
BH501	10	40	0.266 (100-200kPa)	22.428
BH501	12	45	0.456 (100-200kPa)	1.518
BH507	2.0	105	4.023 (12.5-25kPa)	3.054
BH508	3.0	103	4.342 (12.5-25kPa)	3.595
BH512	2.0	68	3.084 (12.5-25kPa)	11.432
BH517	9.0	34	0.207 (100-200kPa)	19.910
BH517	7.0	48	0.226 (100-200kPa)	6.380
BH517	11.50	20	0.142 (100-200kPa)	8.623

Note: M_v & C_v shown for particular pressure range – the respective pressure ranges were chosen to correspond with the loading under which the samples exist in-situ.

Furthermore, shear strength parameters of the alluvial soils were obtained through a series of consolidated undrained Triaxial Compression tests (effective stress with pore pressure measurement) as per BS1377:Part 8:1990 and K H Head Manual of Soil Laboratory Testing vol 3.

Table 11 – Summary of Consolidated undrained Triaxial Compression testing with pore pressure measurement on Alluvial soils in overwater boreholes

BH No.	Sample Depth (m)	Moisture Content (%)	Bulk Density (Mg/m ³)	Dry Density (Mg/m ³)	Shear Strength Parameters		
					c'	φ'	θ
BH503	4.50	61	1.59	0.98	7.5	33.7	29
BH504	3.0	104	1.36	0.67	0	33.7	29
BH505	5.0	71	1.56	0.91	5.6	41	33.5
BH507	2.0	98	1.38	0.70	0	35.3	30
BH508	3.0	107	1.39	0.67	0	33.7	29
BH510	4.0	77	1.48	0.83	3.3	30.6	27
BH512	2.0	78	1.47	0.83	0.5	30.6	27
BH518	2.0	106	1.33	0.65	1.4	33.7	29

6.4 Fluvial / Gravel Deposits

Across the site, intermittently, a thin band of river gravel deposits is noted in the stratigraphy. Natural gravels were observed prior to encountering the stiff to very stiff glacial Clay in a number of boreholes and drillholes (See Table 12). The medium dense and dense Gravel was generally described as subangular to subrounded, fine to coarse of limestone.

Table 12 –Thickness of medium dense / dense GRAVEL measured in boreholes and drillholes across the site

Exploratory Hole Number	Depth of interval brb (m OD)	Stratum Description
BH501	13.0-15.0 (-9.68 to -11.68)	Medium dense grey sandy clayey GRAVEL with high cobble content
RC502	13.50-19.50 (-10.06 to -16.06)	Sandy GRAVEL with occasional cobble
BH508	9.50-10.10 (-10.68 to -11.28)	Medium dense silty/clayey slightly sandy GRAVEL
BH509	4.20-5.30 (-5.34 to -6.44)	Medium dense slightly sandy silty GRAVEL with a medium to high cobble content
BH512	9.0-9.50 (-10.52 to -11.02)	Medium dense grey clayey GRAVEL.
BH517	13.10-13.60 (-10.35 to -10.85)	Medium dense grey brown sandy silty GRAVEL
RC517	13.0-14.30 (-10.25 to -11-.55)	Dense grey silty sandy GRAVEL
BH518	9.0-9.70 (-10.47 to -11.17)	Dense dark grey brown silty sandy GRAVEL

A limited number of particle size gradings were performed on the samples. A grading envelope has been prepared for the samples tested and is presented in Figure 26.

Figure 26 - Grading Envelope for fluvio-glacial Gravel Deposits (Cable Percussion borehole samples)

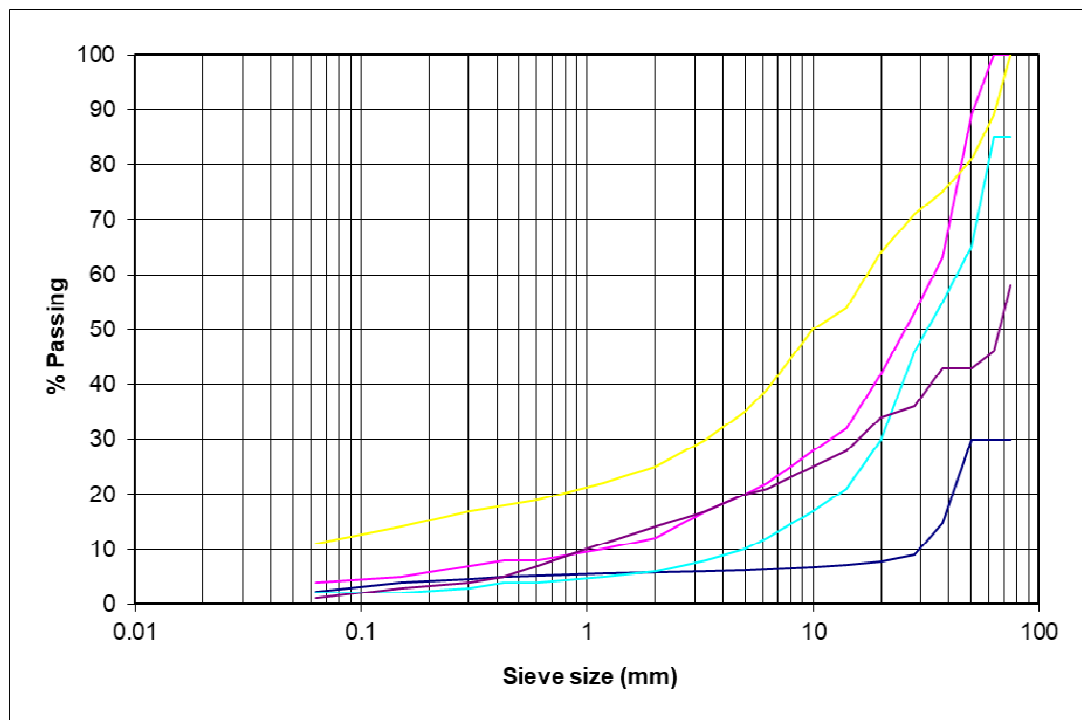

6.5 Glacial Till

With the exception of RC502, a thick cover of heavily over-consolidated fine-grained glacial till was intercepted ahead of eventual rockhead. The clay was, in places, preceded by what was described as medium dense to dense fluvio-glacial gravels. In RC502, Symmetrix openholing reported extensive gravels above rockhead with only thin 'clay layers' noted shy of bedrock. Table 13 lists the depths and levels at which the clay was reported. It also includes a sample description together with approximate clay layer thickness.

Table 13 – Thickness of glacial tills as recorded in cable percussion boreholes and rotary drillholes at each of Britain Quay, Overwater Section and East of R. Dodder areas.

Exploratory Hole No.	Depth to CLAY brb (m OD)	Base of CLAY brb (m OD)	Approx. Measured Thickness (CP + RC)	Soil Description
Britain Quay (West of R. Dodder)				
BH501	15.0m (-11.68m OD)	BH terminated in CLAY	7.50m	Hard grey sandy gravelly CLAY with medium cobble and boulder content
RC501	16.0m (-12.68m OD)	22.50 (-19.18m OD) = <i>Rockhead</i>		Stiff to very stiff dark grey/black sandy gravelly CLAY with occasional cobbles
RC502	19.50m (-16.06m OD)	21.0 (-17.56m OD) = <i>Rockhead</i>	1.50m	Probable highly weathered ROCK with clay layers
Overwater Section (R. Dodder)				
BH503	6.80m (-11.12m OD)	BH terminated in CLAY	8.0m incl occ sandy GRAVEL layers	Very stiff dark grey brown sandy gravelly CLAY with a low cobble content.
RC503	7.90m (-10.47m OD)	14.77m (-17.34m OD) = <i>Rockhead</i>		Stiff to very stiff grey brown slightly sandy gravelly CLAY
BH504	7.40m (-11.10m OD)	BH terminated in CLAY	7.0m	Stiff to very stiff sandy gravelly CLAY with a medium cobble content.
RC504	8.45m (-11.08m OD)	15.35m (-17.98m OD) = <i>Rockhead</i>		Stiff to very stiff grey very gravelly sandy CLAY with a medium cobble content
BH505	9.30m (-10.95m OD)	BH terminated in CLAY	5.20m	Stiff to very stiff black to dark grey brown slightly sandy gravelly CLAY with medium cobble content
RC505	9.90m (-11.50m OD)	15.10m (-16.70m OD) = <i>Rockhead</i>		Very stiff dark brown slightly sandy gravelly CLAY
BH506	9.20m (-11.10m OD)	BH terminated in CLAY	7.50m	Stiff to very stiff black to grey brown slightly sandy gravelly CLAY with a medium cobble content
RC506	8.70m (10.67m OD)	16.20m (-18.17m OD) = <i>Rockhead</i>		Stiff to very stiff dark grey gravelly sandy silty CLAY

BH507	8.40m (-9.86m OD)	BH terminated in CLAY	7.85m	Stiff to very stiff brownish grey to black slightly sandy gravelly CLAY
RC507	8.60m (-10.27m OD)	16.45m (-18.12m OD) = Rockhead		Stiff to very stiff grey silty gravelly sandy CLAY with occasional cobbles
BH508	10.10m (-11.28m OD)	BH terminated in CLAY	7.30m	Stiff to very stiff black slightly sandy gravelly CLAY
RC508	9.0m (-10.30m OD)	16.30m (-17.60m OD) = Rockhead		Stiff to very stiff grey silty gravelly sandy CLAY with occasional cobbles
BH509	5.30m (-6.44m OD)	BH terminated in CLAY	11.75m	Stiff to very stiff greenish brown becoming dark grey brown sandy very gravelly CLAY
RC509	5.60m (-6.84m OD)	17.35m (-18.59m OD) = Rockhead		Stiff dark grey dark brown slightly sandy gravelly CLAY
BH510	6.0m (-7.28m OD)	BH terminated in CLAY	9.85m	Stiff to very stiff dark grey to greenish grey slightly sandy gravelly CLAY
RC510	8.00m (-9.25m OD)	17.85m (-19.10m OD) = Rockhead		Stiff to very stiff grey silty gravelly sandy CLAY with occasional cobbles
BH511	8.0m (-9.84m OD)	BH terminated in CLAY	8.64m	Stiff to very stiff dark grey slightly sandy gravelly CLAY
RC511	7.80m (-9.55m OD)	16.44m (-18.19m OD) = Rockhead		Stiff to very stiff dark grey silty gravelly sandy CLAY with occasional cobbles
BH512	9.50m (-11.02m OD)	BH terminated in CLAY	N/A	Stiff to very stiff black slightly sandy gravelly CLAY
RC512	8.60m (-10.14m OD)	RC terminated in CLAY		Stiff to very stiff dark brownish grey slightly sandy gravelly CLAY
RC512A	7.50m (-9.44m OD)	15.80m (-17.74m OD) = Rockhead	8.30m incl occ sandy GRAVEL layers	Hard dark grey brown slightly sandy gravelly CLAY
BH518	9.70m (-11.17m OD)	BH terminated in CLAY	5.10m incl sandy GRAVEL from 13.20-14.80m	Very stiff slightly sandy gravelly CLAY
RC518	10.50m (-11.97m OD)	14.80m (-16.27m OD) = Rockhead		Stiff to very stiff dark grey / black sandy gravelly CLAY

Works on land east of the River Dodder				
RC515	10.20m (-6.48m OD)	19.70m (-15.98m OD) = Rockhead	9.50m	Stiff grey silty gravelly CLAY
RC516A	10.80 (-7.58m OD)	21.40 (-18.18m OD) = Rockhead	10.50m	Stiff to very stiff dark grey/black silty gravelly CLAY with some cobbles
BH517	13.60m (-10.85m OD)	BH terminated in CLAY	0.90m	Hard brown sandy gravelly CLAY with occasional cobbles and boulders
RC517	14.30m (-11.55m OD)	21.50 (-18.75m OD) = Rockhead	7.20m	Stiff to very stiff dark grey/black silty gravelly CLAY

Multi-stage triaxial compression and one-dimensional consolidation (oedometer) tests were undertaken on selected Geobor S Clay cores. The tests were performed to measure undrained shear strength, coefficient of volume compressibility (Mv) and coefficient of consolidation (Cv). The triaxial test results are summarized in Tables 14 and 15 with the consolidation test findings summarised in Table 16. Inspection of the data in Table 15 shows the undrained shear strengths (Su) classify the glacial till or boulder clay as very high strength (Su 150-300 kN/m²) as defined by Table 9 in BS 5930 (2015) and Table 5 in EN 14688-2:2004. In many cases, the values obtained exceeded the soil/rock boundary of 300kPa (see BS EN ISO 14688-2 and BS EN ISO 14689-1).

The oedometer tests produced coefficients of volume compressibility (Mv) in the range 0.079 to 0.374 m²/MN, with values generally falling between 0.10 and 0.20 m²/MN. This would infer the glacial soils to be of medium compressibility (Mv 0.10-0.30 m²/MN) as defined in Table 2.11 of Tomlinson's Foundation Design & Construction, 7th Ed. These are somewhat higher than could be expected for heavily over-consolidated glacial till and probably attributable to stress relief or disturbance during preparation for the oedometer cell.

Table 14 - Summary Details of Triaxial Multistage Tests on Glacial Till Soils recovered in Geobore S

BH No.	Sample Depth (m)	Moisture Content (%)	Cell Pressures (kN/m ²)			Undrained Shear Strength (Su) kN/m ²		
			STAGES			STAGES		
			1	2	3	1	2	3
RC505	10.60	5.5	225	350	475	909	1090	1214
RC509	7.30	9.2	200	275	350	363	421	437
RC509	11.80	7.9	200	275	350	751	794	830

Table 15 - Summary Details of Triaxial Tests on Geobor S - cored Glacial Till

BH No.	Sample Depth (m)	Moisture Content (%)	Cell Pressure (kN/m ²)	Undrained Shear Strength (Su) kN/m ²
RC507	9.80	8.6	200	143
RC507	11.30	9.2	200	158
RC507	14.30	16	275	350
RC508	14.80	5.3	275	377
RC510	9.80	7.9	200	135
RC510	11.30	8.5	225	370
RC510	12.80	9.5	225	213
RC511	10.80	5.1	200	871
RC511	12.30	7.0	225	434
RC511	13.80	6.9	225	368
RC512	10.0	8.2	200	548
RC512	11.20	5.7	225	324
RC512A	10.70	6.1	200	245
RC512A	14.70	7.3	275	628

Table 16 - Summary Details of Consolidation Tests on over-consolidated Glacial Soils

Exploratory Hole	Sample Depth (m bgl)	Moisture Content (%)	M _v (m ² /MN)	C _v (m ² /yr)
RC503	9.30	6.1	0.135 (150-250kPa)	11.054
RC505	10.60	4.8	0.101 (100-200kPa)	28.951
RC509	14.80	6.2	0.161 (100-200kPa)	27.959
RC510	8.30	27	0.374 (50-150kPa)	9.160
RC510	9.80	7.3	0.261 (50-150kPa)	28.567
RC512	12.80	10	0.094 (100-200kPa)	18.713
RC510	15.80	8.2	0.212 (100-200kPa)	23.239
RC511	10.80	6.5	0.186 (100-200kPa)	32.447
RC511	12.30	7.9	0.156 (100-200kPa)	6.863
RC511	16.0	10	0.133 (100-200kPa)	12.385
RC512	10.0	5.9	0.204 (50-150kPa)	33.951
RC512A	10.70	5.1	0.079 (100-200kPa)	29.534
RC512A	14.70	7.1	0.195 (100-200kPa)	27.025

Note: M_v & C_v shown for particular pressure range – the respective pressure ranges were chosen to best reflect the loading under which the samples exist in-situ.

Geotechnical index tests were carried out on glacial till samples and results presented in Appendix 15 of the factual report. Moisture contents vary from 2.6 to 13% with values more typically ranging from 6 to 8%. The Atterberg Limits demonstrate the glacial till is low plasticity clay (CL) in nature plotting above the A-line on the Casagrande Chart (refer to Figure 27). Plasticity Indices vary from 8 to 14%. The particle size gradings (refer to Figure 28 for grading envelope) demonstrate fines content to be mostly in the range 20 to 40%. There are occasional exceptions to this where lenses of silty/clayey sandy GRAVEL exist (e.g. BH504 at 8.0m & BH503 at 10.80m).

Figure 27 – Atterberg Limit Plot (Glacial Deposits)

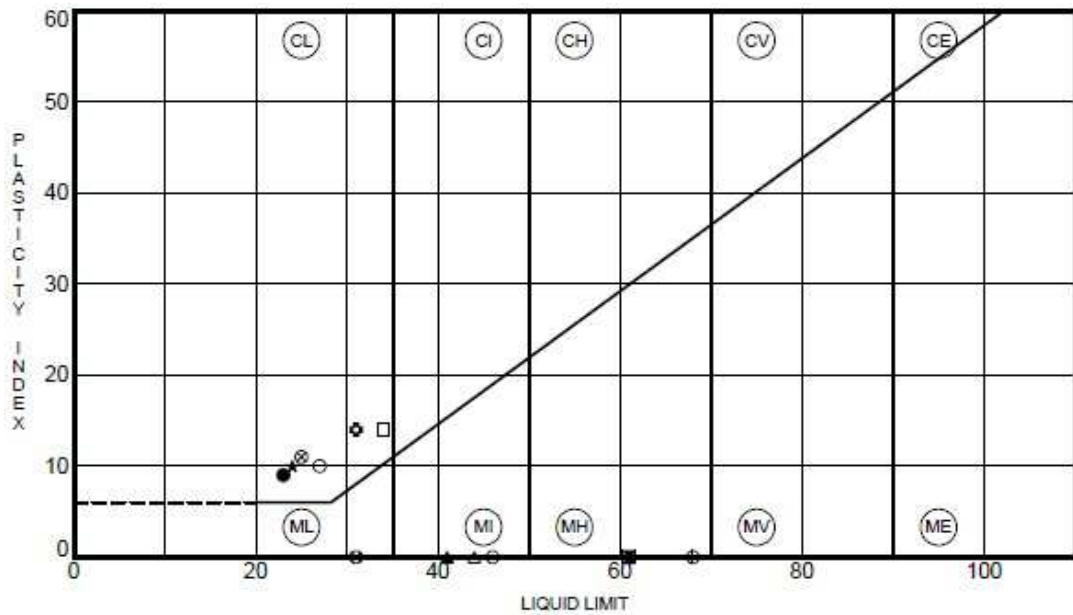
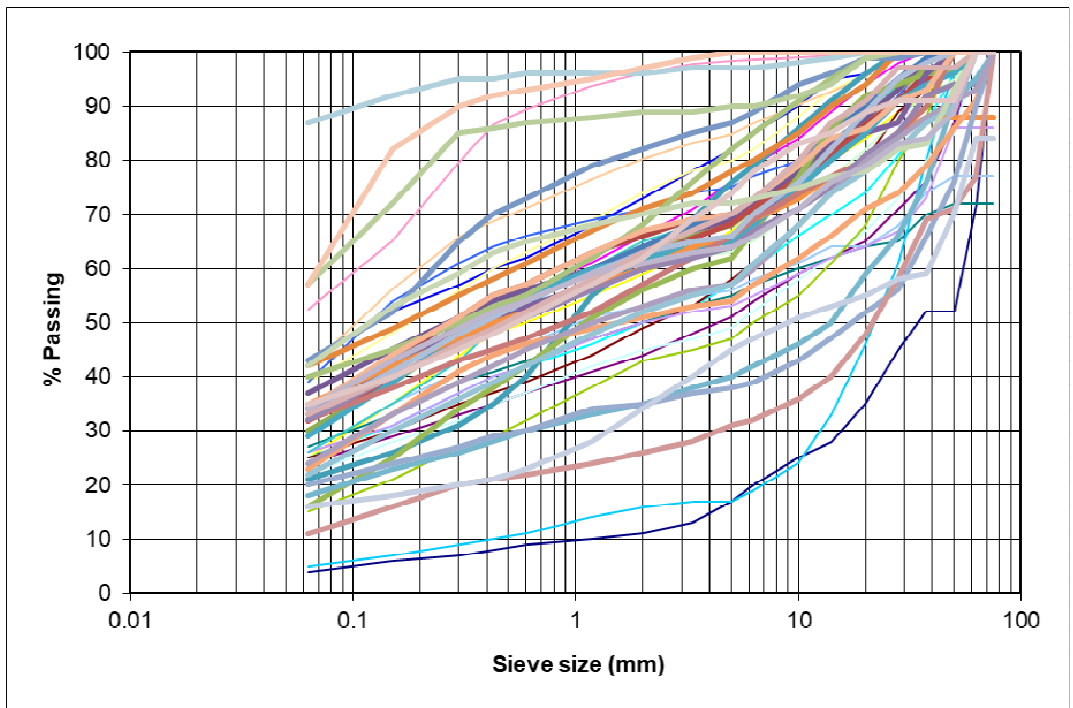

Figure 28 – Grading Envelope (Glacial CLAY / Till)



SPT's were performed in the percussive boreholes and rotary drillholes to evaluate shear strength. An SPT N-Value against depth plot has been prepared and is shown in Figure 29. The data provides an understanding of the increasing strength of the till with depth. Using the Stroud and Butler correlation between SPT N-Value and undrained shear strength (taking $C_u \approx 4$ to $6N$) the blow-counts mainly demonstrate the presence of very stiff glacial till material.

As can be seen from the SPT Vs Depth plot, multiple refusals were recorded (i.e., 50 hammer blows, before 300mm of penetration is achieved) across all drilling records. The glacial till (core recovery shown from RC511 in Figure 30) can be classed as having upper bound high strength (i.e. 75 to 150 kN/m²) to very high strength (i.e. 150 to 300 kN/m²) as defined in Table 5 of EN 14688-2:2004.

Figure 29 – SPT data plot Vs depth for CLAY and CLAY/SILT deposits across the site

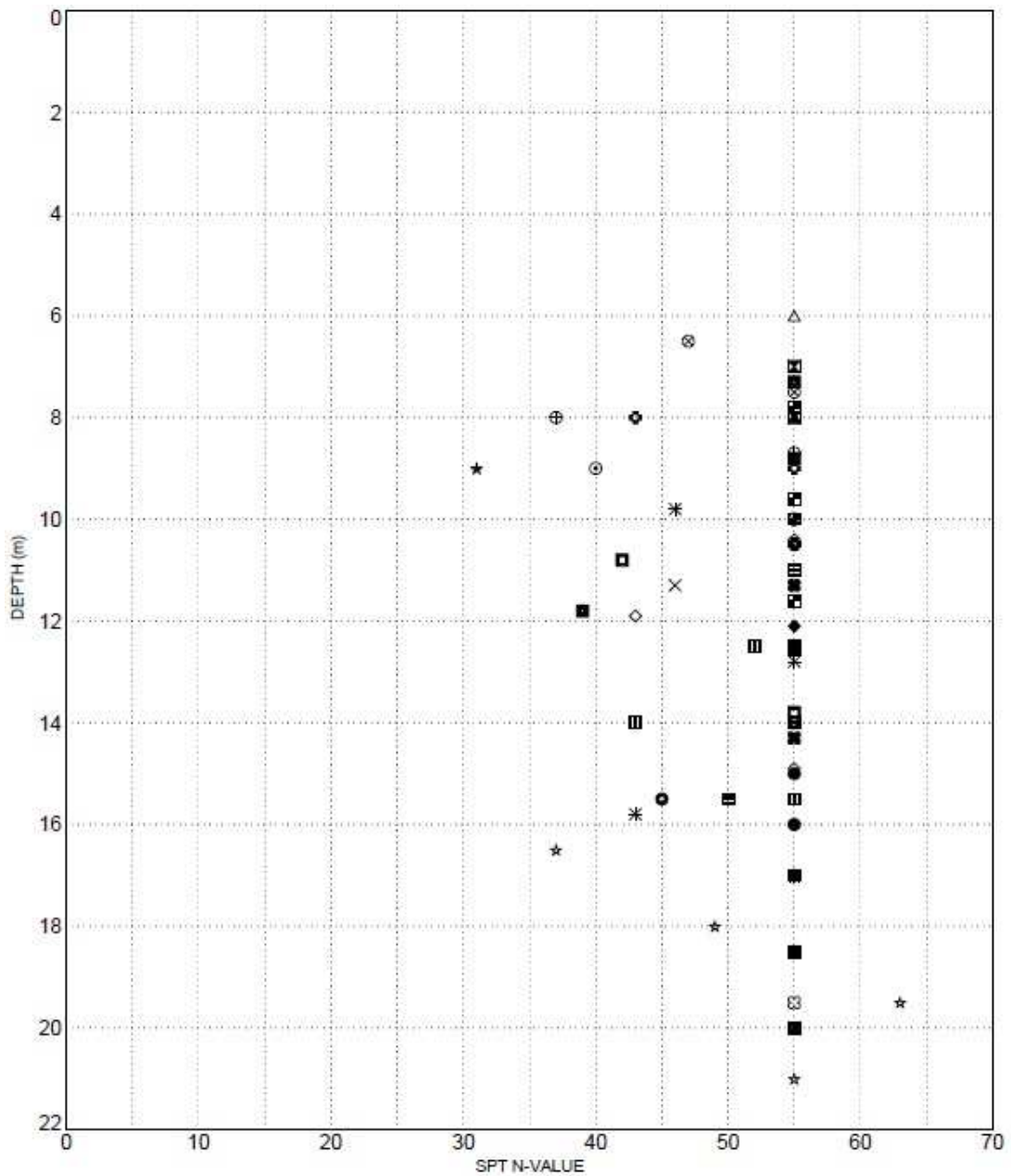

Figure 30 – Cored Glacial Deposits transitioning into upper Rockhead in Corehole RC511.
Weathered rockhead logged at 16.44m brb with competent rock from 16.68m brb (-18.43m OD).



6.6 Bedrock

Reference to the GSI map for the area (Figure 31, Geology of Ireland 1:1,000,000 scale (2013)) shows that the rotary core drillholes were positioned within the Lucan Formation (LU). The Lucan Formation (Nolan 1986, 1989) forms the bulk of the basinal rocks throughout the geologically termed ‘Dublin Basin’ and is characterised by graded, intraclastic skeletal packstone/grainstone interbedded with anoxic calcareous mudstone / black shale, laminated calcisiltite and argillaceous micrite (i.e. impure limestone with clay minerals).

Its base is defined by the first appearance of thick graded beds of limestone, and a marked decrease in the proportion of interbedded shale, compared with the underlying Tober Colleen Formation. The Lucan Formation is widely known as the Calp Limestone (Marchant and Sevastopulo, 1980) but is also referred to as the Upper Dark Limestone and has long been a source of building materials and aggregate for Dublin. The Calp is largely undifferentiated geologically.

Figure 31 - Bedrock Geology Map for the Area (Adapted from the Geology of Ireland 1:1,000,000 scale map series). Site marked red and white circle.

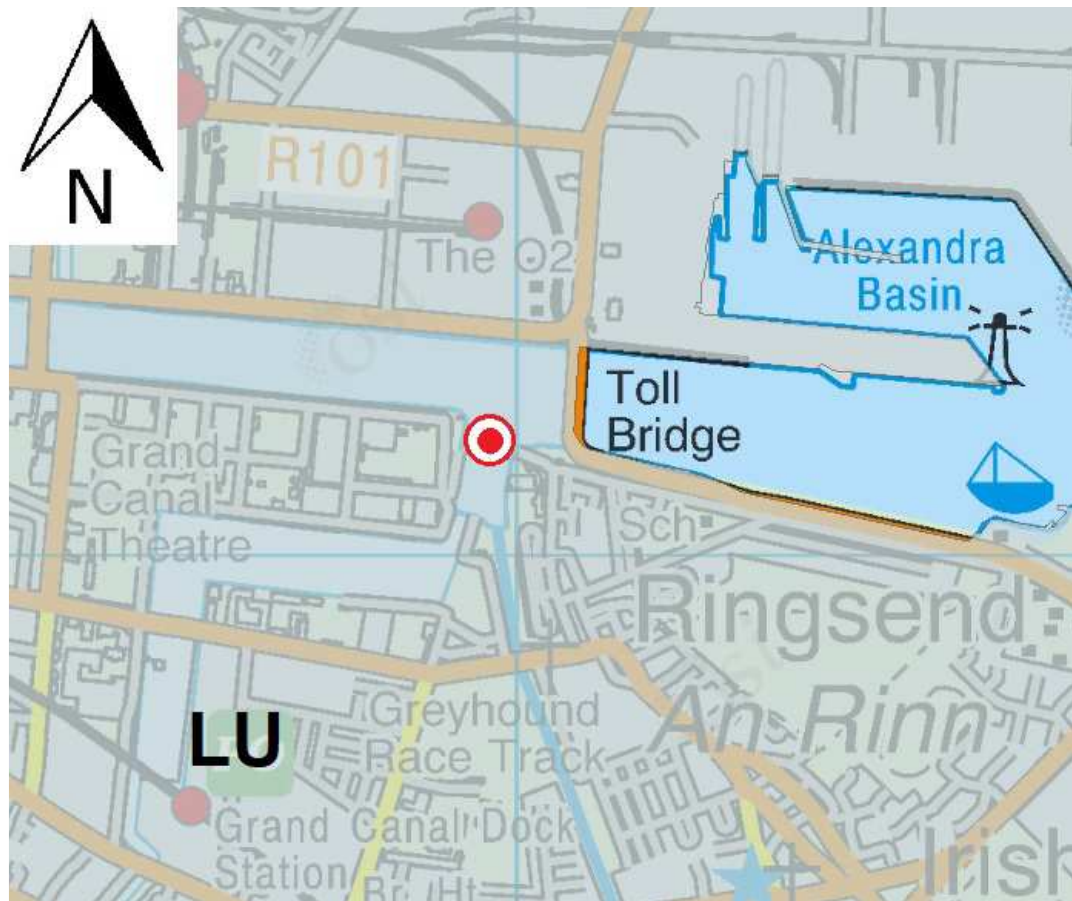

Key: LU = Lucan Formation

The rotary drillholes show that bedrock typically consists of dark grey and black strong and medium strong fine grained predominantly muddy / argillaceous LIMESTONE (refer to Table 17). Shaley bands, often weathered, of weak calcareous MUDSTONE and SHALE were observed in a number of holes most especially where fissile bedding marks a pronounced carbonaceous cleavage. Weak, structureless zones were also noted in the core record, e.g., in RC504 from 16.45m to 18.75m bgl where non-intact rock fragments were observed (Figure 32). Due to the very stiff nature of the overlying glacial till allied with its thickness (7-8m on average), many of the cable percussion boreholes were terminated shy of proving rockhead.

Table 17 - Summary Detail of Corehole Lithologies

Rotary Hole	Rock Characteristics
<p>General Rock Core Description</p>	<p>Strong to medium strong dark grey and grey black fine grained thin to medium bedded muddy LIMESTONE with rare thickly spaced (~0.80m) very thin to thin interbeds of medium strong to weak black fine grained shaley MUDSTONE (bands 50-100mm thick).</p> <p>Weathering: Reduction in strength of extremely closely spaced shaley MUDSTONE to very weak, rarely extremely weak. Rare orange brown non-penetrative staining on fracture surfaces.</p>

Figure 32 – Core Recovery in RC504



Discontinuity spacings for subhorizontal fracturing (Set 1) within the rotary cores generally range from very closely to widely spaced but are predominantly closely (60 to 200mm) to medium spaced (200 to 600mm). Steeper dipping discontinuities (Set 2) exhibit dips ranging from 60° to locally sub-vertical. The discontinuity surfaces are typically smooth, planar, clean and tight apertures. Often the

fractures are incipient in nature. Rare non-penetrative iron oxide staining is noted in the higher angle, partly open fractures. Rare thin (<2mm) clay smearing is also apparent on fracture surfaces.

The extensive diametral point load strength index (PLSI) test data produced $I_s(50)$ values ranging from 0.40 to 15.66 MPa with a mean value of approximately 4 MPa (refer to Figure 33). The range of strengths obtained from PLSI testing is displayed by the random plot scatter in Figure 33 and is further reflected by the disparities in RQD values recorded during core logging. The RQD values illustrate the closely fractured nature of the variably weathered bedrock / weaker muddy limestone and the more medium spaced fracturing of the more competent limestone rock cores (Figure 25). However, for the most part, the values recorded in PLSI testing indicate the presence of strong to very strong rock cores.

Using a correlation factor (K) of 20 to assess compressive strength, this suggests a large strength envelope in the order of 8 to 300 MPa and categorizes the bedrock as varying from weak (5.0 to 12.50 MPa) to extremely strong (>250 MPa) with an equivalent average compressive strength of 80MPa or strong (50 to 100MPa). The visual strength descriptors determined during engineering geological logging point to the existence of chiefly strong (50 – 100 MPa) to medium strong (25 – 50 MPa) bedrock.

Unconfined Compressive Strength [UCS] testing was undertaken on a number of core samples. Tables 18 and 19 present the results obtained from testing. It can be seen from the rock description column that the sample specimens were described as grey or dark grey fine-grained limestone or muddy limestone. Given the interbedded nature of the bedrock, it would be reasonable to assume some test specimens would comprise mudstone. The reason for the absence of mudstone samples is largely due to the weak and very weak strength of this lithology. As the mudstone is not as well cemented as the limestone it is found in smaller core lengths, i.e., its fracture spacing is generally very close to close (20 – 200mm). Bieniawski & Bernede (1979) state that a height to diameter ratio of 2.5-3.0 is recommended for UCS test specimens. This would require test specimens of at least 220mm in length. Therefore, adequate test specimens of sufficient length were not obtainable. Where carried out, the testing reaffirms the generally medium strong to strong nature of the limestone rock. ISO 14689:2017 (E) rock strength parameters are drawn on Figure 34 to allow correlation between the UCS and Point Load Strength tests. A correlation factor (K) of 20 was used to plot the ISO 14689:2017 (E) MPa strength divisions on the Point Load strength ($I_s(50)$) plot (Figure 33).

Figure 33 – $I_s(50)$ strengths obtained from diametrial Point Load Strength Index testing.
 Reduced levels used in plot to allow for comparison of overwater and land rock cores

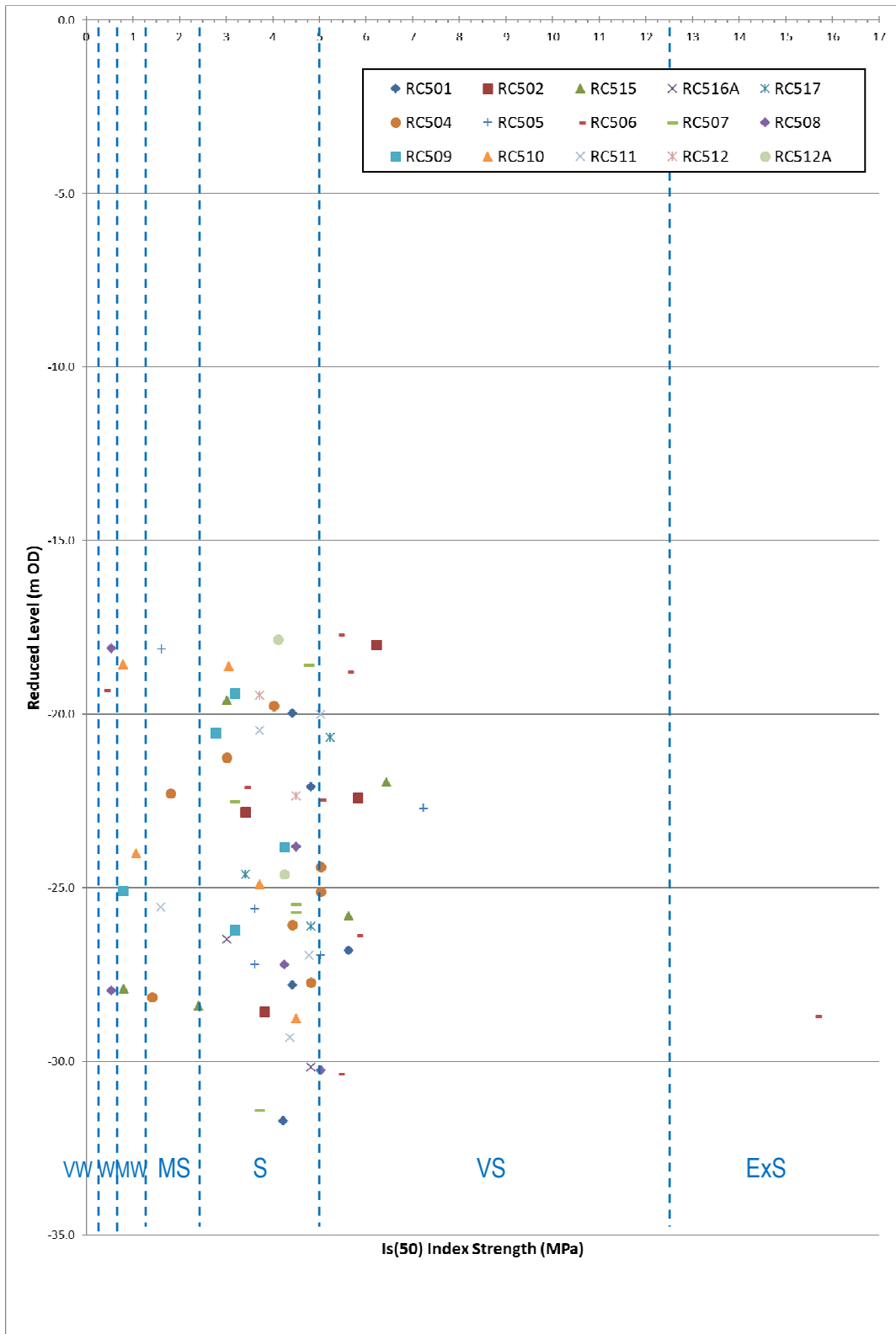

VW = Very Weak, W = Weak, MW = Moderately Weak, MS = Medium Strong, S = Strong, VS = Very Strong, ExS = Extremely Strong
 (ISO 14689:2017 (E))

Table 18 - Unconfined Compressive Strength [UCS] test results from Land-based coreholes

Exploratory Hole	Depth (m)	Level (m OD)	UCS (MPa)	Rock Strength (ISO 14689:2017 (E))	Rock Description
Locations 501, 502, 515, 516A & 517					
RC501	24.0	-20.555	37.67	Medium Strong	Dark Grey fine grained Muddy Limestone
RC501	28.70	-25.255	80.99	Strong	Dark Grey fine grained Muddy Limestone
RC501	30.30	-26.855	48.55	Medium Strong	Dark Grey fine grained Muddy Limestone
RC502	23.20	-19.884	113.01	Very Strong	Dark Grey fine grained Muddy Limestone
RC502	23.60	-20.284	59.64	Strong	Dark Grey fine grained Muddy Limestone
RC502	26.30	-22.984	53.02	Strong	Dark Grey fine grained Muddy Limestone
RC515	26.20	-22.479	98.32	Strong	Dark Grey fine grained Muddy Limestone
RC515	30.60	-26.879	75.76	Strong	Dark Grey fine grained Muddy Limestone
RC516A	24.60	-21.378	83.91	Strong	Dark Grey fine grained Muddy Limestone
RC516A	27.30	-24.078	31.18	Medium Strong	Dark Grey fine grained Muddy Limestone
RC517	27.80	-25.053	95.19	Strong	Dark Grey fine grained Muddy Limestone

Table 19 - Unconfined Compressive Strength [UCS] test results from Overwater coreholes

Exploratory Hole	Depth (m)	Level (m OD)	UCS (MPa)	Rock Strength (ISO 14689:2017 (E))	Rock Description
Locations 503, 504, 505, 506, 507, 508, 509, 510, 511, 512					
RC503	25.20	-27.766	40.06	Medium Strong	Grey fine grained Limestone
RC504	22.15	-24.78	58.39	Strong	Dark Grey fine grained Muddy Limestone
RC504	24.55	-27.18	91.24	Strong	Dark Grey fine grained Muddy Limestone
RC504	26.65	-29.28	100.24	Strong / V Strong	Dark Grey fine grained Muddy Limestone
RC505	25.60	-27.202	32.80	Medium Strong	Dark Grey fine grained Muddy Limestone
RC505	27.30	-28.902	46.26	Medium Strong	Dark Grey fine grained Muddy Limestone
RC506	21.40	-23.372	94.17	Strong	Dark Grey fine grained Muddy Limestone
RC506	23.20	-25.172	50.44	Strong	Dark Grey fine grained Muddy Limestone
RC506	26.80	-28.772	84.97	Strong	Dark Grey fine grained Muddy Limestone
RC506	27.50	-29.472	65.71	Strong	Dark Grey fine grained Muddy Limestone
RC506	28.0	-29.972	55.04	Strong	Dark Grey fine grained Muddy Limestone
RC506	28.20	-30.172	68.43	Strong	Dark Grey fine grained Muddy Limestone
RC506	30.0	-31.972	88.94	Strong	Dark Grey fine grained Muddy Limestone
RC507	22.90	-24.565	58.38	Strong	Grey fine grained Limestone
RC507	24.0	-25.665	26.68	Medium Strong	Grey fine grained Limestone
RC507	22.60	-24.265	36.35	Medium Strong	Grey fine grained Limestone
RC507	29.20	-30.865	68.64	Strong	Grey fine grained Limestone
RC508	23.80	-25.099	84.40	Strong	Grey fine grained Limestone
RC508	28.80	-30.099	60.95	Strong	Grey fine grained Limestone
RC509	17.20	-18.437	26.68	Medium Strong	Dark Grey fine grained Muddy Limestone
RC509	26.90	-28.137	76.37	Strong	Dark Grey fine grained Muddy Limestone
RC510	27.40	-28.652	57.76	Strong	Grey fine grained Limestone
RC510	25.60	-26.852	56.17	Strong	Grey fine grained Limestone
RC511	21.70	-23.454	80.98	Strong	Grey fine grained Limestone
RC511	27.80	-29.554	58.86	Strong	Grey fine grained Limestone
RC512	23.60	-25.142	67.31	Strong	Grey fine grained Limestone

Figure 34 – UCS strengths (MPa) obtained from core testing
 Reduced levels used in plot to allow for comparison of overwater and land rock cores

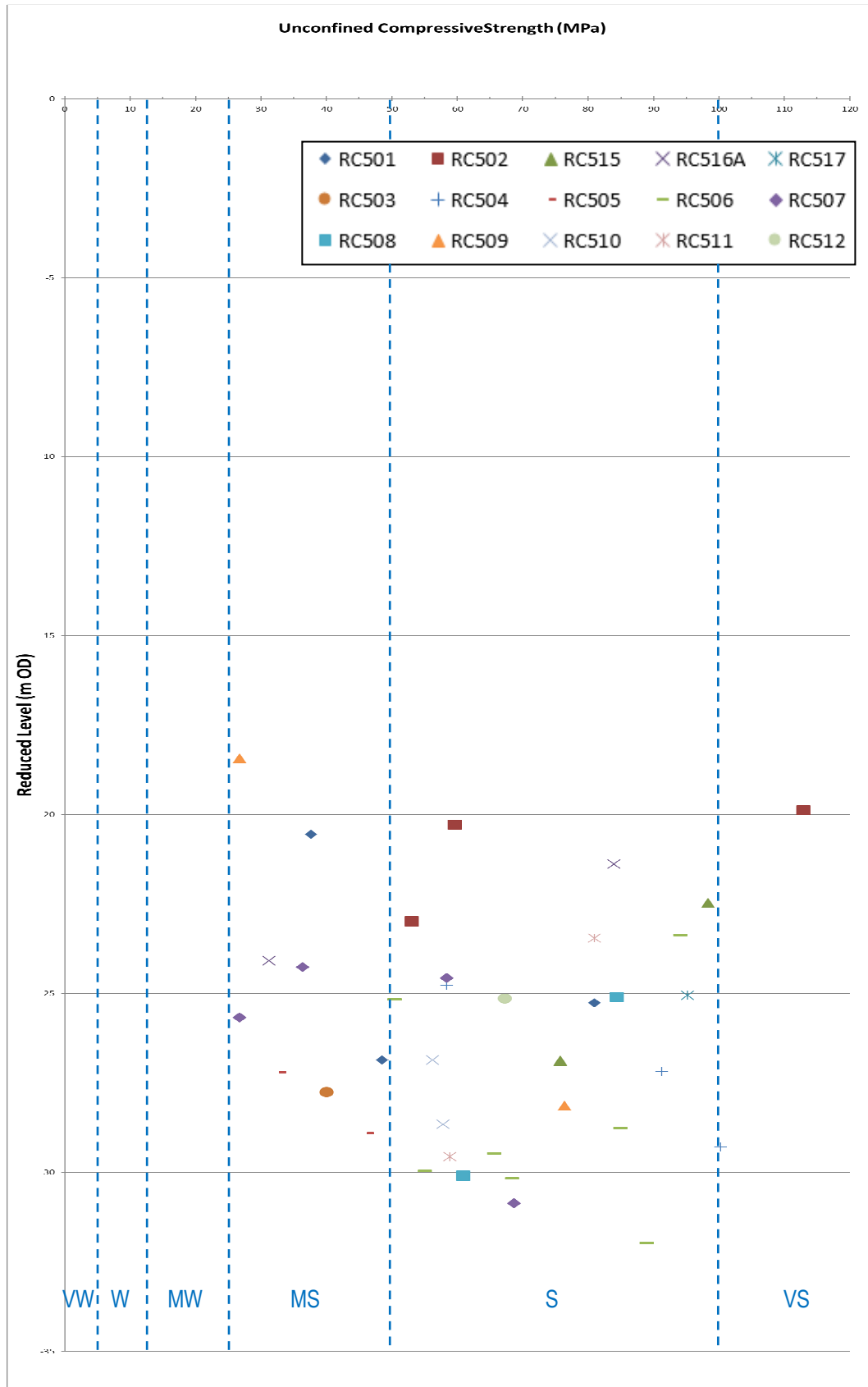

VW = Very Weak, W = Weak, MW = Moderately Weak, MS = Medium Strong, S = Strong, VS = Very Strong
 (ISO 14689:2017 (E))

6.7 Groundwater

Groundwater strikes were encountered across the site in a number of land boreholes and drillholes. Table 20 summarises the various strikes as noted by the drilling crews. In both RC501 and RC516A, groundwater monitoring standpipes (50mm diameter standpipes) were installed following coring. Standpipe RC501 was dipped on 19th September 2019 following installation. Given the positioning of the site at the confluence of the River Liffey and Dodder, at which point both are tidally influenced, the water levels measured in the various boreholes / coreholes mirror that of the local tidal regime. The installation of a data logger in RC516A on the eastern bank of the Dodder serves to highlight the influence of the Spring tides on water levels (See Appendix 14 of factual report).

Blowing sands were reported by the cable percussion borehole driller at a depth in BH502 (12.0 to 13.50m). This indicates the effect water pressures have locally on deeply buried shifting sands. Shallow trial pits and slit trenches remained dry during excavation.

Table 20 – Water ingress in cable percussion borehole and rotary core drillhole locations

Exploratory Hole No.	Water Struck m bgl (m OD)	Water Rose to m bgl	Rate of Flow	Range in measured water levels m bgl (m OD)
Britain Quay (West of R. Dodder)				
BH501	3.50 (-0.18)	3.10	Moderate	
RC501	3.10 (0.22)	-	Slow	3.70 (-0.38)
BH502	3.50 (-0.05)	-	Moderate	
RC502	3.60 (-0.15)	-	Slow	
Works on land east of the R. Dodder				
BH515A	3.50 (0.22)	-	Slow	
RC516A	Data Logger Recording 04 Feb 2019 – 01 Mar 2019			
BH517	3.30 (-0.55)	-	Seepage	
BH517	3.80 (-1.05)	-	Slow	

6.8 Geotechnical Parameters

The ground conditions and associated properties of the superficial deposits and bedrock units have been discussed in the previous sections. On foot of the field and laboratory test results, derived geotechnical parameters are presented in Table 21. It is highlighted that the parameters shown in Table 21 are derived values (not characteristic values) in line with EN1997-1 CL 3.4.3. Design parameters should be carefully selected for the ground conditions / profiles at each particular area within the River Dodder site.

Table 21 – Derived Geotechnical Parameters

Parameter	Alluvial Soils	Coarse Grained Glacial Soils	Fine Grained Glacial Till	Mudstone / Shale Interbeds	Limestone
Moisture Content (%)	31 to 124 (note extremely variable)	4.2 to 11	2.3 to 13%, typically 6 to 8%		
Plasticity Index (%)	Non-Plastic	Non-Plastic	9 - 14		
Bulk Unit Weight (kN/m³)	15	20	24	24	26
Angle of Shearing Resistance (∅)	27°	34°	36° (Stiff / Very Stiff Till)	26°	38°
SPT N-Value	5 (Land) 2 (Marine)	14-Refusal (>50)	30+, commonly with refusal (>50) (Stiff / Very Stiff Till)		
Undrained Shear Strength (Soils)	11-22 kN/m ² (Land) 0-11 kN/m ² (Marine – Vane Testing)		>150 kN/m ² (Stiff / Very Stiff Till)		
Compressive Strength (Rock)				0.3 MPa a in distinctly weathered & extremely weak Mudstone. 0.6 MPa in partially weathered very weak or weak Mudstone	80 MPa in strong to medium strong muddy Limestone

Young's Modulus / Stiffness (E)			100 MPa (Very stiff Glacial Till)	80 MPa in distinctly weathered weak Mudstone 150 MPa in partially weathered Mudstone	4 GPa in medium strong Limestone 11 GPa in strong to very strong Limestone
Consolidation Mv Cv	0.1-4.3 m ² /MN 1.5-22 m ² /Year		0.10* – 0.20 m ² /MN 7-32 m ² /Year		

* Typical value (0.10 m²/MN) for low compressibility Boulder Clay as suggested in Tomlinson (2001)

For foundation design (pile) and modeling purposes, an undrained shear strength of 5 (marine) to 15 kN/m² (land) and friction angle (ϕ) of 27° are considered reasonable for the very low strength alluvial soils. Inspection of the SPT data plot for the fine grained glacial till shows SPT N-Values mainly ranging from 35 to 45, regularly reporting 'refusals' which suggests a very stiff or hard consistency. An undrained shear strength of at least 150kN/m² could be adopted for the very stiff till. A friction angle of 36° is suggested for the heavily over-consolidated stiff to very stiff fine-grained till (based on the relationship between SPT N-Value and ϕ as suggested by Thorburn, 1974). The coarse grained glacial or fluvio-glacial deposits (slightly clayey/silty or sandy GRAVEL) appear to be very intermittent and where encountered were noted as medium dense to dense. Therefore, an angle of shearing resistance (ϕ) of the order of 34° is deemed to be reasonable.

A disparity exists between the friction angle (ϕ) value suggested for the mudstone bedrock (26°) and the more prominent limestone (38°) as assigned in Table 21. The friction angle for the mudstone may appear somewhat conservative but is suggested as a result of the inherent weathering variations (as identified in a number of the rotary cores) and incipient discontinuities in the rock mass. Given the variability in core quality (largely attributable to the interbedded nature of the lbedrock formation), it would be prudent to adopt a conservative compressive strength for design of piles founded in the variably weathered limestone / mudstone rock mass. For pile design and ground anchor calculations in the marine environment, a rock mass strength of the order of 25 MPa is suggested for the interbedded rock mass.

7. GROUND ASSESSMENT & RECOMMENDATIONS

7.1 General

On foot of the findings from the exploratory works and laboratory testing, the following items are assessed for civil engineering design purposes:

- Foundation systems
- Protection of buried concrete
- Geotechnical hazard & risk management assessment

7.2 Foundation Systems

It is understood that Dublin City Council propose to construct a transportation bridge over the River Dodder linking Britain Quay and Thorncastle Street. It is likely that the bridge will incorporate a bascule-type section thereby allowing river traffic to gain access from the River Liffey to Grand Canal Dock and vice versa. The exploratory boreholes (Geobore S coring and conventional rotary coring) along the bridge corridor permitted the recovery of soil and rock core samples from beneath the river bed as well as on the adjoining quayside. Cross Sections / Ground Models 'North Alignment' and 'South Alignment' (refer to Appendix 2) demonstrate the levels at which rock was recovered in exploratory boreholes across the c.100m wide river mouth. It is noted that interpolation of strata between investigatory points is for visual assistance. Only the information gathered at exploratory points should be taken as factual.

The exploratory boreholes suggest a high degree of consistency in rockhead topography with bedrock elevations of between -15 and -20m OD. The laboratory strength testing (point load strength index) indicated the rock as being typically strong with unconfined compressive strength (UCS) testing for the overwater cores indicating strong to medium strong bedrock (refer to Tables 18 & 19). It should be noted that UCS testing is performed on the intact core specimens, hence the results reflect the more competent core and this may provide a somewhat unrealistic or overly high strength assessment. Given the presence of rare, thickly spaced (~1m wide) very thin to thin interbeds of weak mudstone, a bearing capacity of 1MPa could be adopted for the spread footing foundation design in the competent rock mass. Overlying the medium strong to strong Limestone bedrock, the very stiff clast dominant till was noted to be generally 7 to 8m thick and quite consistent in composition. As mentioned in Section 6.8, an undrained shear strength of at least 150kN/m² could be adopted for the structural design or temporary works design purposes in the very stiff (very high strength) glacial till.

Options for construction of the bridge piers include caisson construction or sheet piled cofferdams. Piling could be considered where smaller scale piers are envisaged. Construction of the larger bascule pier and associated excavation works is likely to require either caisson or cofferdam installation. With the exception of a Gravel lense intercepted between 11.80-13.30m brb (-14.37 to -15.87) in BH503, below initial silts a uniformly very stiff glacial till was encountered in each of the boreholes at the proposed Bascule Pier. Driving sheet piles into this largely impermeable layer should achieve a positive cut-off and allow excavation with minimal dewatering expected (unless seepage or ingress occurs through poorly interconnected pile clutches).

Depending on loads, the clay layer or the underlying limestone rockhead could be used to site the bridge foundation. The presence of pipe-jacked utility tunnels within the glacial soils will demand careful consideration when choosing pile embedment depth at certain locations in proximity to St. Patrick's Rowing Club. The very soft to soft consistency and highly compressible nature of the upper alluvial soils would necessitate excavation and removal before considering any potential foundation solution be it caisson or cofferdam construction. The overlying silt would offer little strength in relation to pile capacity (based on in-situ vane tests and laboratory testing on piston and U100 samples) and would contribute negative skin friction ('downdrag') in determining pile load capacity.

If a caisson is favoured for the bascule (to reduce the potential build time on-water), then a box caisson could be designed and floated to site. The box caisson could be sunk and filled in-situ either on pre-formed piles (bored to the required bearing strata) or alternatively, following the dredging of the low strength alluvial deposits on to a suitable level platform constructed on to the underlying glacial soils. Constructing on piles would limit the need to remove significant thicknesses of upper silt and would also permit pile penetration to the underlying bedrock which would significantly increase the available foundation bearing capacity. Abutment loads are unknown but as a guideline, the piles should attain a minimum rock socket embedment of five times the pile diameter.

7.3 Protection of Buried Concrete

The chemical tests on the soil samples from the land and over-water boreholes show that water soluble sulphate (SO_4) values range from <10 to 2200 mg/l. The results largely fall into BRE Class DS-2 (500 - 1500mg/l) and reference should be made to Appendix 3. However, some samples, predominantly those from onland exploratory holes were found to lie in DS-3 classification. Chloride contents were determined for both onland and overwater samples and these range from 470 to 6600 mg/l.

Table 22 outlines the sample locations where elevated sulphate values were obtained. Table C1 in BRE SD1 (2005) can be used in the selection and design of concrete. Based on the results obtained from samples at Britain Quay (in particular those from BH501), on elevated sulphate results reported for indigenous sandy silts and an upper cover of Made Ground sandy gravelly silt/clays and silty gravel, DS-3 design sulphate class is advised. Assuming mobile groundwater conditions, AC-3 class should be adopted given the pH values (7.6 to 8.7) determined.

Similar conditions exist on land east of the River Dodder in BH517 where samples of naturally occurring very soft grey brown very sandy SILT revealed the presence of BRE Class DS-3 (1500-3000mg/l) sulphates. The exceedances of DS-2 type are highlighted in bold font in Table 22. Again, assuming mobile groundwater conditions, AC-3 class would be realistic given the 7.8-8.2 pH values obtained.

From tests conducted on samples acquired from over-water boreholes, it was found that, yet again, those samples in the upper SILT horizons sometimes exceeded DS-1 limits and occasionally DS-2 classification (BH504 2.0-3.0m, 2200mg/l sulphate as SO_4). Samples from the underlying stiff and very stiff CLAY generally fell into DS-1 category with SO_4 mg/l contents <500 mg/l. Given the presence of an elevated reading in BH504, it would be prudent to design for DS-3 sulphate class conditions. As before, given mobile groundwater conditions, AC-3 class should be adopted given the pH values (7.7 to 9.0) obtained from the testing.

In relation to the riverside structures and proximity to the River Liffey corrosion of steel should be considered for the intertidal / splash and immersion zones with the relative aggression depending on salinity, temperature and oxygen content. Browne & Domone (1974) states that deterioration of concrete / internal reinforcement from almost all these causes can be prevented by providing 50mm of more cover to the reinforcement and by using a rich mix (not leaner than 1 : 1.5 : 3) well compacted to give a dense impermeable concrete.

In terms of potential chloride attack and possible corrosion of steel reinforcement, assuming that the chloride contents of the materials used for mixing the concrete are within specified limits, that admixtures containing chloride are not used, and that the cover to the steel is appropriate to the exposure conditions (see BS 8110), there should be little risk of corrosion damage (Tomlinson, 2001). In terms of steel sheet piles, Morley and Bruce (1983) quoted rates of 0.08mm / year for normal sea water and 0.1 to 0.25mm / year for the splash zone. A protective coating can be applied to the piles (sheet piles) but this can be of limited value as wastage of 0.08mm per year on a steel pile would be significant. Cathodic protection (sacrificial anode systems) is available to maintain integrity of steel piles with a zinc silicate priming coat followed by vinyl or epoxy coal tar paint.

Ultimately, the thickness of the metal should be increased to allow for wastage by corrosion. Low corrosion steel (e.g. AMloCor as supplied by Arcelor Mittal) is now regarded as a very effective solution to ensure durability and reduce loss of steel thickness due to corrosion.

Table 22- Sulphate (2:1 Water Soluble) as SO₄ Exceedances Over BRE DS-1 category
(as per Table C1 in BRE SD-1 2005)

WESTERN BANK / BRITAIN QUAY
[DS-3 classification]

Sample ID		BH501	BH501	BH501	BH501	BH501	BH502	BH502
Depth Interval		2-2.5	5-5.5	7-7.5	9-9.5	11-11.5	2-2.5	9-9.5
pH		7.6	8.3	8.2	8.7	8.2	7.9	8
Sulphate (2:1 Water Soluble) as SO ₄	mg/l	1280	984	1670	1490	1240	816	630
Chloride (Water Soluble)	mg/l	510	1700	2600	3500	4800	1800	520

EASTERN BANK in proximity to TOM CLARKE BRIDGE & ST. PATRICK'S ROWING CLUB
[DS-3 classification]

Sample ID		BH517	BH517	BH517	BH517	BH517	BH517	BH517
Depth Interval		2	5	7	10	14.5	2	5
pH		7.8	7.9	7.9	8.2	8.2	7.8	7.9
Sulphate (2:1 Water Soluble) as SO ₄	mg/l	1450	1530	1550	1890	1340	1450	1530

Overwater Section
[DS-3 classification]

Sample ID		BH503	BH504	BH504	BH505	BH505	BH505
Top Depth		2.5	2.0-3.0	7	2	4	8
pH		8.1	7.7	8.1	7.9	8.1	8.1
Sulphate (2:1 Water Soluble) as SO ₄	mg/l	900	2200	630	1400	770	1000
Sample ID		BH506	BH509	BH503	BH507	BH518	BH509
Top Depth		9	2	8	3	3	7
pH		8.5	8.4	8.2	8.1	8	8.1
Sulphate (2:1 Water Soluble) as SO ₄	mg/l	560	970	750	1200	690	1200

7.4 Geotechnical Hazard & Risk Management Assessment

A detailed ground investigation and a clear understanding of the ground conditions provides an effective means of managing geotechnical risk (Clayton, 2001). The design for the River Dodder bridge crossing should specifically identify and consider the risks associated with civil engineering in an overwater and quayside environment. Possible foundation systems that may be considered by the designer have been outlined in Section 7.2.

As noted in Managing Geotechnical Risk (ICE & DETR, 2001), geohazard identification is not solely about using data to predict the ground conditions but to assess potentially unfavourable conditions that may be encountered. This allows the geotechnical risks to be managed in a systematic manner and achieve as much certainty as possible during the construction stage. Table 23 outlines the key risk factors or geohazards identified by IGSL, which could impact on construction of the overwater bridge infrastructure at the River Dodder.

Examination of Table 23 shows that based on the geotechnical and geophysical information gathered from the investigations (including the desk study), the degree of risk or risk levels are classed as mainly significant or intolerable.

Table 23 – Geotechnical Hazard (Risk Factors) Assessment for River Dodder Crossing

Key Risk Factor / Geohazard	Undesirable Events or Occurrences	Consequences	Assessed Degree of Risk
Very soft / very low strength alluvial soils	Excessive lateral deflections of piles	Serviceability & performance of piles to support bridge structure	Significant (8)
	Sheet pile or cofferdam instability & excessive lateral deflection	Unable to work safely, need for additional bracing or walings	Significant (8)
Variations in weathering state & strength of Limestone / Mudstone	Presence of more extensive weathering or fracturing in the rock mass, ie., brecciation or faulting	Constraints with penetration of piling equipment and lower than expected pile capacity	Significant (8)

Aggressive corrosion on sheet piles or cofferdams	Chemical attack on steel and foundation concrete	Integrity of concrete and piles. Potential damage to concrete.	Significant (8)
Contamination in made ground and alluvial sediments	Elevated levels of contaminant substances and disposal off site to appropriate landfill	Prevent disposal of material to designation area, programme delays.	Substantial (12)
Debris on river bed or presence of buried waste	Inability to form piles due to obstructions	Disrupt piling programme and cause associated delays	Significant (8)

Degree of Risk 1 – 4 Trivial, 5 – 8 Significant, 9 -12 Substantial, 13 – 16 Intolerable
(Categories based on ICE /DETR, 2001)

7.5 Ground Models

Following on from the detailed ground investigation findings, ground models are developed for both the Dodder Bridge and Eastern Approach and secondly for the works proposed for the St Patrick’s Rowing Club, associated underpass and land reclamation.

7.5.1 Main Dodder Transportation Opening Bridge & Eastern Approach

Cross sections / ground models entitled ‘North Alignment’ and ‘South Alignment’ (refer to Appendix 2) illustrate the ground profile or stratigraphy from west to east across the mouth of the River Dodder and adjoining quays - Britain Quay to the west and South Wall Quay / Thorncastle Street to the east. The rockhead profile can be seen to be particularly uniform across the river mouth with a consistent thickness of glacial till cover overlying the bedrock, if slightly tapered towards the west. The very soft and soft alluvial deposits vary in their thickness, being scoured from the record adjacent to Britain Quay (See Figure 15 taken from Hydrographic Surveys Report No. PH18021_Report_Rev.00).

Below indigenous loose SAND and soft alluvial SILT in RC02, an approximately 6m thick deposit of sandy GRAVEL was intercepted between 13.0m and 19.0m bgl (c. -10 to -16m OD). Subsurface Section ‘South Alignment’ highlights the presence of this potential fluvial or fluvio-glacial channel which either scours the underlying glacial till or lies within the fine grained till. Its absence in RC501 may suggest that this is a somewhat localised feature rather than a relict river channel associated with the River Dodder. Elsewhere, in BH503 a similar gravel lense was intercepted between 11.80m and 13.30m brb (-14.37 to -15.87m OD). The section entitled ‘Possible Gravel Channel’ (Appendix 2) links the two gravelly stratum. It is noted that interpolation of strata between investigatory points is for visual assistance. Only the information gathered at exploratory points should be taken as factual.

The Made Ground on both flanks of the river vary in composition, being particular to the period of time both quay walls and nearby infrastructure were developed. As mentioned in Section 5.1, it is thought that the Britain Quay wall section was constructed when the entry lock system for the Grand

Canal Docks was built in 1795 (Bunbury, 2008). Behind the quay wall, the Made Ground was found to comprise chiefly silty sandy GRAVEL to a depth of 8.0m bgl (-4.68m OD). It is likely that this material was dredged from the Liffey bed. The naturally occurring, underlying loose grey silty SAND at 8.0m was found to be continually “blowing” to a depth of 13.0m bgl (-9.68m OD). This is due to the in situ water pressures within the deeply buried stratum.

On the western side of the river mouth, towards the north side of the former South Quay Wall, cable percussion termination depths ranged between 0.80m and 2.0m. The exception to this was at borehole BH515A where a depth of 5.20m bgl (-1.48mOD) was achieved. All bores and trenches conducted north of the former South Quay Wall intercepted exclusively Made Ground. It was reported as mixed grey brown gravelly CLAY and, at depth in BH515A, black silty GRAVEL. The strata were found to contain variable amounts of cobbles, boulders, brick, concrete, timber, plastic, leather, ceramics & asbestos pipe fragments. Figures 19A and 19B (dated late 1880’s to c.1920’s) indicate the presence of sand and shingle immediately north of the South Quay Wall. Figures 9A, 9B, 10 and 18A-18C illustrate the building of the East Link Bridge (Tom Clarke Bridge) and depict the placement of the mixed starter layer which was used to build out an artificial promontory or approach to the East Link Bridge. Slit trenches ST02B and ST03 both highlight the difficulty experienced in excavating through these soils due to the presence of large boulders which were used as coarse capping during East Link bridge construction (Figure 35).

Figure 35 – Made Ground / Fill Profile in Slit Trench ST02B & ST03 - Fig 35A Made Ground comprising Topsoil over soft sandy CLAY with brick, concrete and limestone boulders. Pit extended to 1.20m bgl. **Fig 35B** Tarmacadam over leanmix to 0.55m bgl with underlying Made Ground comprised of brown clayey sandy GRAVEL with angular cobbles and boulders. Pit ended at 1.0m on abundant boulder-type obstructions.



Fig 35A



Fig35B

South of the South Quay Wall, borehole BH517 described a makeup of 4.30m (-1.55m OD) of Made Ground before intercepting indigenous soft alluvial silts. The fill material was logged as grey brown clayey Gravel with brick, bone and ash to c. 1.50m with a further 2-3m of brown very clayey silty GRAVEL and gravelly SILT extending to natural soils. A slit trench on Thorncastle Street, outside of the Portview Apartment building, reported soft brown sandy gravelly CLAY with brick, ash, timber and animal bone from 0.20m bgl to 1.30m depth (trench end depth). This illustrates clearly the

contrasting makeup of Made Ground on the Eastern Approach to the Dodder Bridge both north and south of the old quay wall.

A terrestrial 2D-MASW survey (MA04) was performed on the Eastern Approach to the proposed river crossing at Thorncastle Street. The velocities obtained mirror the soil consistencies revealed in exploratory holes. Shear wave velocities between 150 and 600 m/s obtained around elevations of 0 to -5 mOD are thought to represent the relatively soft or loose sediments, likely river deposits / silts (blue shading in Figure 36). The increase in velocity below this layer indicates a transition to stiff glacial till or dense gravels (red colour in Figure 36). In the case of BH517 / RC517, it is not until a depth of c. 13.0m (-10m OD) that medium dense GRAVEL followed by very stiff CLAY are encountered (Appendix 2 - Subsurface Section 'North Alignment'). Shear modulus of between 46 and 700 MPa have been derived for the MASW profile (Figure 36 taken from MGX File Ref: 6345f-005.doc).

Figure 36 – Section of 2D Shear Modulus for MA04 conducted north of the South Quay Wall off Thorncastle Street. (in kPa) (taken from MGX File Ref: 6345f-005.doc)

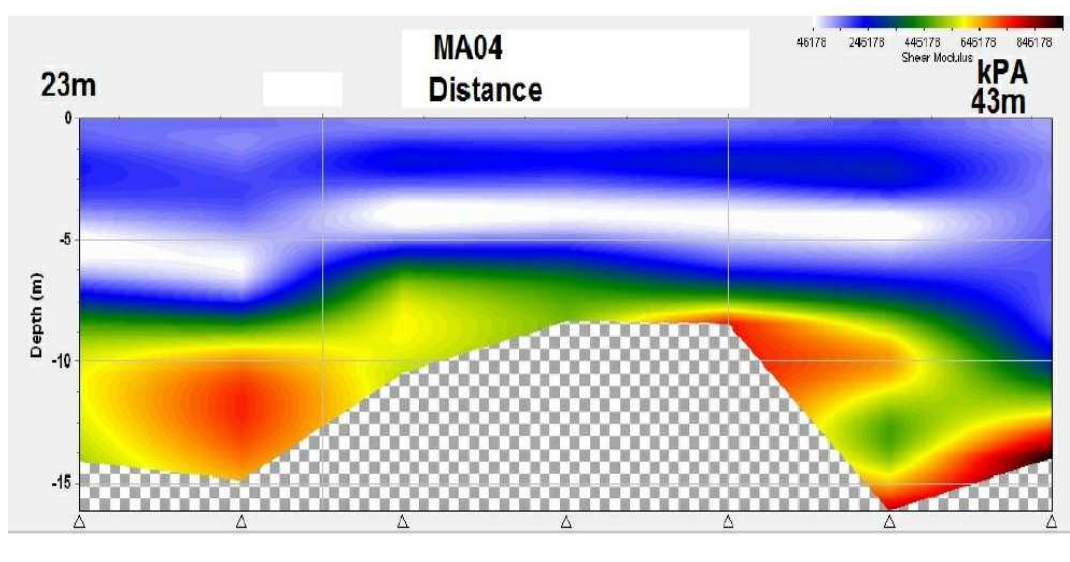

7.5.2 Land Reclamation, Access Underpass & relocated St. Patrick's Rowing Club

Two cross sections / ground models entitled 'St Patrick's towards Access Underpass' and 'North Shore & St Patrick's Rowing Club' (Appendix 2) detail both the superficial and bedrock geology for the area. As the proposed new North Shore lies off-shore in an area of tidal mudflats (Figure 37), no anthropogenic interference was documented in either of the two exploratory hole positions. The presence of recently installed pipe-jacked service tunnels at depth (Liffey Services Tunnel and High-Pressure Gas Pipeline) directed to North Wall Quay in addition to the nearby Liffey Tunnel will inevitably complicate groundworks in the area if deep-seated piles are envisaged. Exploratory holes 513 and 514 were both cancelled due to the spatial constraints imposed by both Tom Clarke Bridge and the existing St. Patrick's Rowing Club Jetty in addition to the proximity of live tunnel infrastructure.

Section 'North Shore & St. Patrick's Rowing Club' details the presence of a consistent thickness of soft and very soft alluvium to depths of 7.50 and 9.0m below river bed [brb] (c. -10m OD). Marine seismic refraction and marine 1D MASW were carried out in these areas. However, the seismic data recovered does not relay refractions or surface waves from deeper layers like boulder clay or bedrock as the seismic energy does not penetrate the thick mantle of very soft river bed sediments. The accumulation of such very soft silt and mud-type sediments at the river bed of the Dodder and Liffey confluence attenuates the seismic energy. This is typical for these 'mud banks' and gaseous

organogenic sediments present under the river, especially in the summer time, and this gas stops seismic energy from penetrating the ground.

As with RC502 and RC503, a thin layer of sandy GRAVEL was found at depth in RC512A associated with the glacial till. The Gravel was reported between 13.0m and 14.65m brb (-15.0 to -16.65m OD). Otherwise, both RC511 and RC512A reported very stiff and stiff grey brown CLAY to eventual rockhead at -18.19m OD and -17.74m OD.

Figure 37 – Jack-up drilling platform hoisted over mudflats at low tide during drilling works at RC512A (pictured 08 Sept 2018). View beyond to Tom Clarke Bridge and Dublin Port.



An approximately N/S section entitled 'St Patrick's towards Access Underpass' signifies a similar, consistent, straight-line trend in rockhead topography (c. -18.50m OD). Fluctuations occur in alluvium thickness with greater sequences observed onland in both BH517 (4.30m bgl – 13.10m bgl) and RC517 (3.50m bgl – 13.0m bgl) where up to 9.50m of soft Silt and loose silty Sand were recorded. This contrasts to nearby RC/BH509 where a mere 4.20m and 5.60m of black SILT were recorded prior to encountering the underlying stiffened till. This variation in alluvium may present challenges when considering reclamation / dig depths in an area coincident with the underpass location.

REFERENCES

1. Archiseek (n.d.). 1907 – South Hailing Station, Britain Quay, Dublin. Retrieved from <http://archiseek.com/2010/navigation-aid-britain-quay-dublin/>
2. Atkins, (n.d.). Liffey Services Tunnel. Retrieved from <http://atkinsireland.ie/engineering/liffey-services-tunnel-dublin/>
3. Atkins (2002). River Liffey Service Tunnel, General Arrangement Plan Sections Sheet 1 of 2, 1:500 [Drawing no. 1746RL003]. Atkins, Unpublished Report.
4. Bieniawski, Z.T., Bernede, M.J. (1979, April). Suggested methods for determining the uniaxial compressive strength and deformability of rock materials: Part 1. Suggested method for determining deformability of rock materials in uniaxial compression In International Journal of Rock Mechanics and Mining Sciences & Geomechanics Abstracts (Vol.16, Issue 2, pp. 138-140). New York: Elsevier.
5. Bord Gais Eireann (2000). Abbotstown to Poolbeg Gas Pipeline – Strip Map – (As Laid), 1:1000H, 1:100 V [Drawing no. BGE/69/AL/25]. Murphy International Ltd, Unpublished Report.
6. BRE Special Digest SD 1, Concrete in Aggressive Ground, 2005
7. Bridges of Dublin (n.d.). Gallery >> Tom Clarke Bridge. Retrieved December 06, 2019 from the Bridges of Dublin website <http://www.bridgesofdublin.ie/gallery/view/east-link-bridge-construction>
8. Brooking, C (1728). *Brooking's Map of Dublin*. Retrieved from the Dublin Docklands website <http://www.dublindocklands.ie/sites/default/files/Planning/Public%20Relam/PR%20Masterplan-Archaeological%20%26%20Historical%20Survey%202017.pdf>
9. Brown E.T., (1984) Rock Characterization Testing and Monitoring, ISRM Suggested Methods.
10. Browne, R.D., & Domone, P.L.J. (1974). The long term performance of concrete in the maritime environment, in *Proceedings of the Conference on Offshore Structures, Institution of Civil Engineers*, London, pp. 31-41.
11. BS 1377 (1990) Methods of Testing of Soils for Civil Engineering Purposes, British Standards Institution (BSI).
12. BS 5930 (2015) Code of Practice for Site Investigation, British Standards Institution (BSI).
13. BS 8110-1 (1997). Structural use of concrete. Code of practice for design and construction, British Standards Institution (BSI).
14. Bunbury, T (2008). Dublin Docklands – An Urban Voyage. Dublin, Montague Publications Group on behalf of the Dublin Docklands Development Authority
15. Clayton, C.R.I. (2001) Managing geotechnical risk: improving productivity in *UK building and construction*, Thomas Telford, 80pp. Institution of Civil Engineers.
16. Corporation of Dublin (n.d.). *Vарту Waterworks - Liffey Tunnel & Shafts - Site Plan and Section between Shafts. Contract No. 1, Sheet No. 1*

17. Dublin City (n.d. A). DCR025 Grand Canal Docks 1833. Retrieved from the Dublin City website <http://www.dublincity.ie/image/libraries/dcr025-grand-canal-docks-1833>
18. Dublin City (n.d. B). *POD035 Detail from map showing Grand Canal Dock and Sir John Rogerson's Quay, 1926*. Retrieved from the Dublin City website <http://www.dublincity.ie/image/libraries/pod035-grand-canal-dock>
19. Dublin City (2010, August). The Irish Glass Bottle Company, Ringsend. Retrieved from the Dublin City website <http://www.dublincity.ie/dublin-buildings/irish-glass-bottle-company-ringsend>
20. Dublin Port and Docks Board (1926). *The Port of Dublin : Official Handbook to the Port of Dublin*. Dublin Wilson Hartnell & Co.
21. Goodbody, R. (2014). *Irish Historic Towns Atlas, no. 26, Dublin, Part III, 1756 to 1847, pp 1-106*. Dublin, Royal Irish Academy.
22. Hydrographics Surveys (2018, September). *River Dodder Bathymetric and Geophysical Survey Report* [No. PH18021_Rev.01]. Unpublished Report
23. International Society of Rock Mechanics [ISRM] (1981). *Rock Characterisation, Testing and Monitoring: ISRM Suggested Method*. Oxford, Pergamon Press.
24. Lennon, C. (2008). *Irish Historic Towns Atlas, no. 19, Dublin, Part II, 1610 to 1756, pp 1-40*. Dublin, Royal Irish Academy.
25. Marchant T.R. and Sevastopulo G. D. (1980). *The Calp of the Dublin District*. *Journal of Earth Sciences*, 3(2), pp195-203.
26. Morley, J., & Bruce, D.W. (1983). *Survey of Steel Piling Performance in Marine Environments*. Final Report. Commission of European Communities, Luxembourg, Doc. EUR 8492 EN.
27. Nicholls, H. (1929). *The Construction of a Tunnel Under the River Liffey*. *Transactions of the Institute of Civil Engineers of Ireland, Vol 55*, 185-230.
28. Nolan, S. C. (1986). *The Carboniferous geology of the Dublin area*. Unpublished Ph.D. Thesis, University of Dublin.
29. Nolan, S.C. (1989) *The style and timing of Dinantian synsedimentary tectonics in the eastern part of the Dublin Basin, Ireland*. In: Arthurton, R.S., Gutteridge, P., and Nolan, S.C. (eds). *The role of tectonics in Devonian and Carboniferous sedimentation in the British Isles*. Yorkshire Geological Society Occasional Publication, 6, pp83-98.
30. Roughan & O'Donovan (2018, January). *Outline Scheme Proposals Sheet 1, 1:400* [PDF drawing]. Retrieved from https://consultation.dublincity.ie/traffic-and-transport/dodder-public-transportation-opening-bridge-public/supporting_documents/DPTBRODC1SWEDRGEN0010302.pdf
31. *Site Investigation Practice: Assessing BS 5930 (1986)*, Geological Society Special Publication, No. 2.
32. Tomlinson M.J. (2001). *Foundation Design and Construction, 7th Edition*. London, Pearson Education Limited.

Appendix 1

Exploratory Hole Site Plan

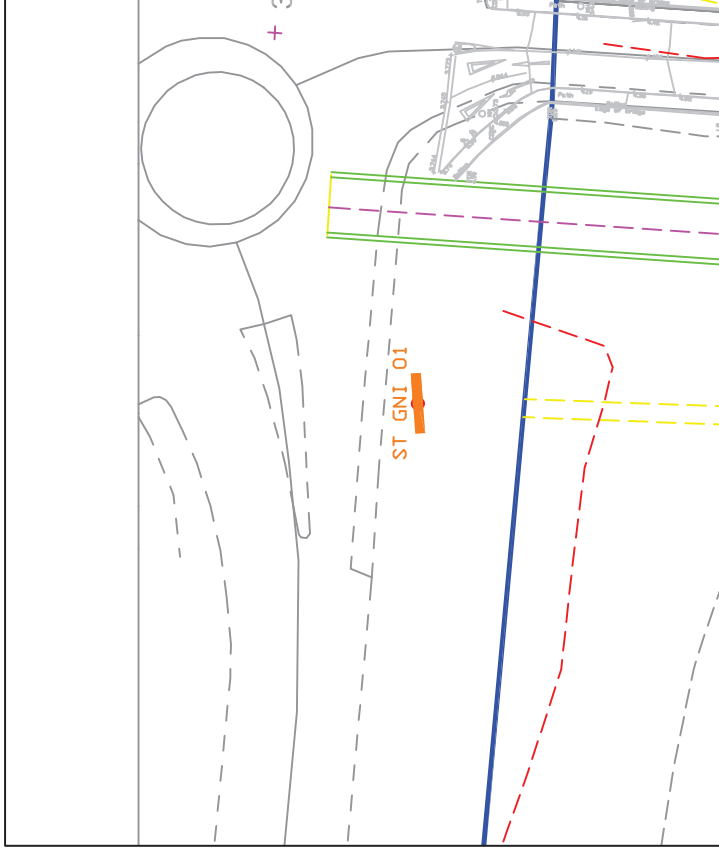
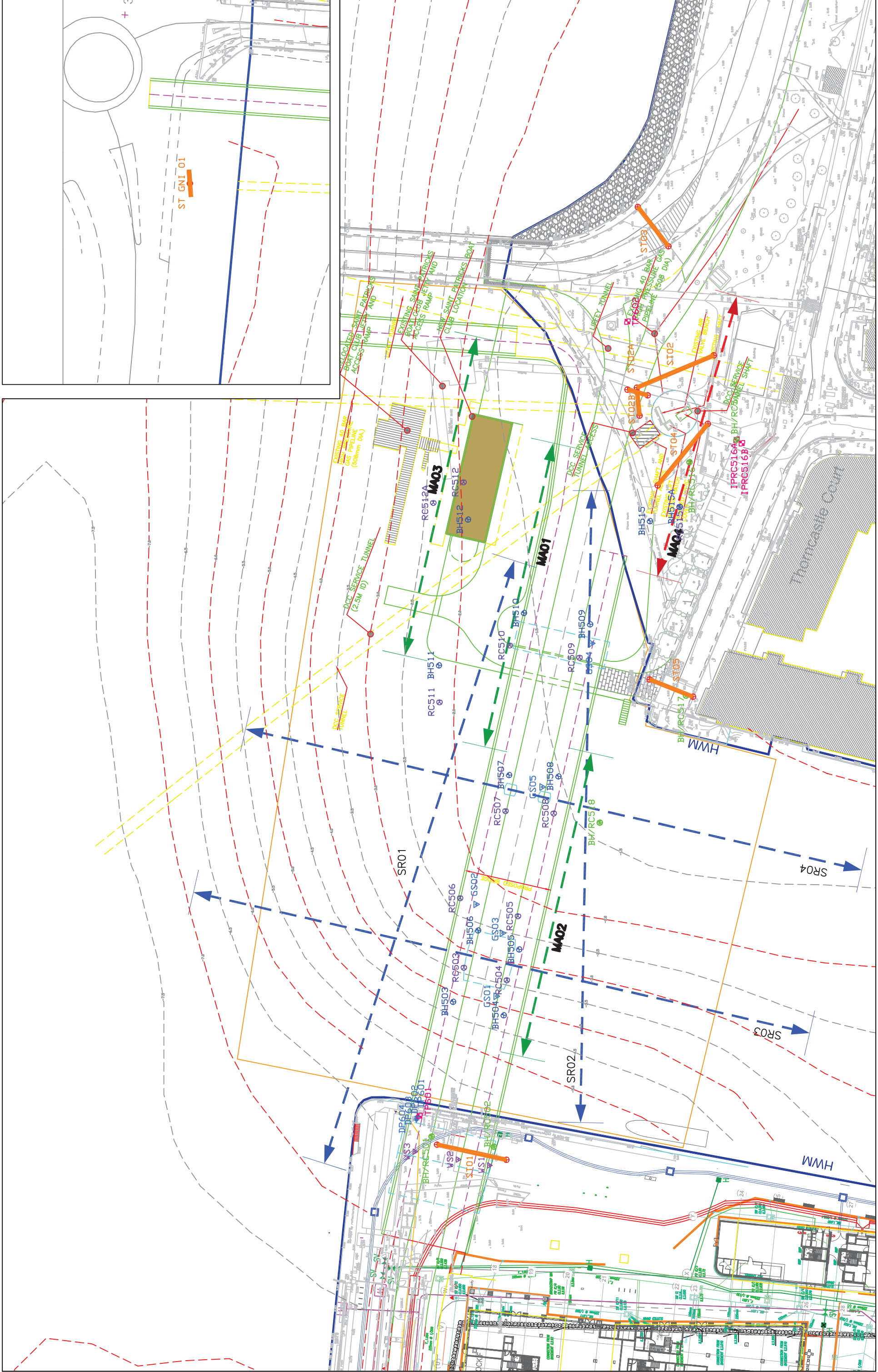

Project: River Dodder Public Transportation Opening Bridge	
Component: Detailed Site Investigation Contract	
Title: Location Plan	File Name: 21105
Designed: CK	Date: 07/11
Drawn: CK	Date: 07/11
Checked: JL	Date: 07/11
Original Scale: 1:750 @/A3	Drawing No: 21105-000-101
Date: 07/11/2019	Date: 07/11/2019

Rev	By	Date	Description
0	CK	07/11	Layout Plan

IGSL Limited
 Unit 11 RT Business Park, Newry, Co. Down
 Tel: 0300 000 0000
 Email: info@igsl.ie

SITE INVESTIGATION
 GEOTECHNICAL SPECIALISTS



SR Location



North



Scale: 1:750 @/A3

Window Samples

- Dynamic Probe Location
- Grab Samples Location

S&A Borehole Location

- Rotary/Cebers S Borehole Location
- Borehole/Rotary Location

Trial Pit Location

- Silt Trench Location

Appendix 2

Stratigraphic Cross-Sections / Ground Models

- I. South Alignment W-E
- II. North Alignment W-E
- III. Possible Gravel Channel
- IV. North Shore & St Patrick's Rowing Club
- V. St Patrick's towards Access Underpass

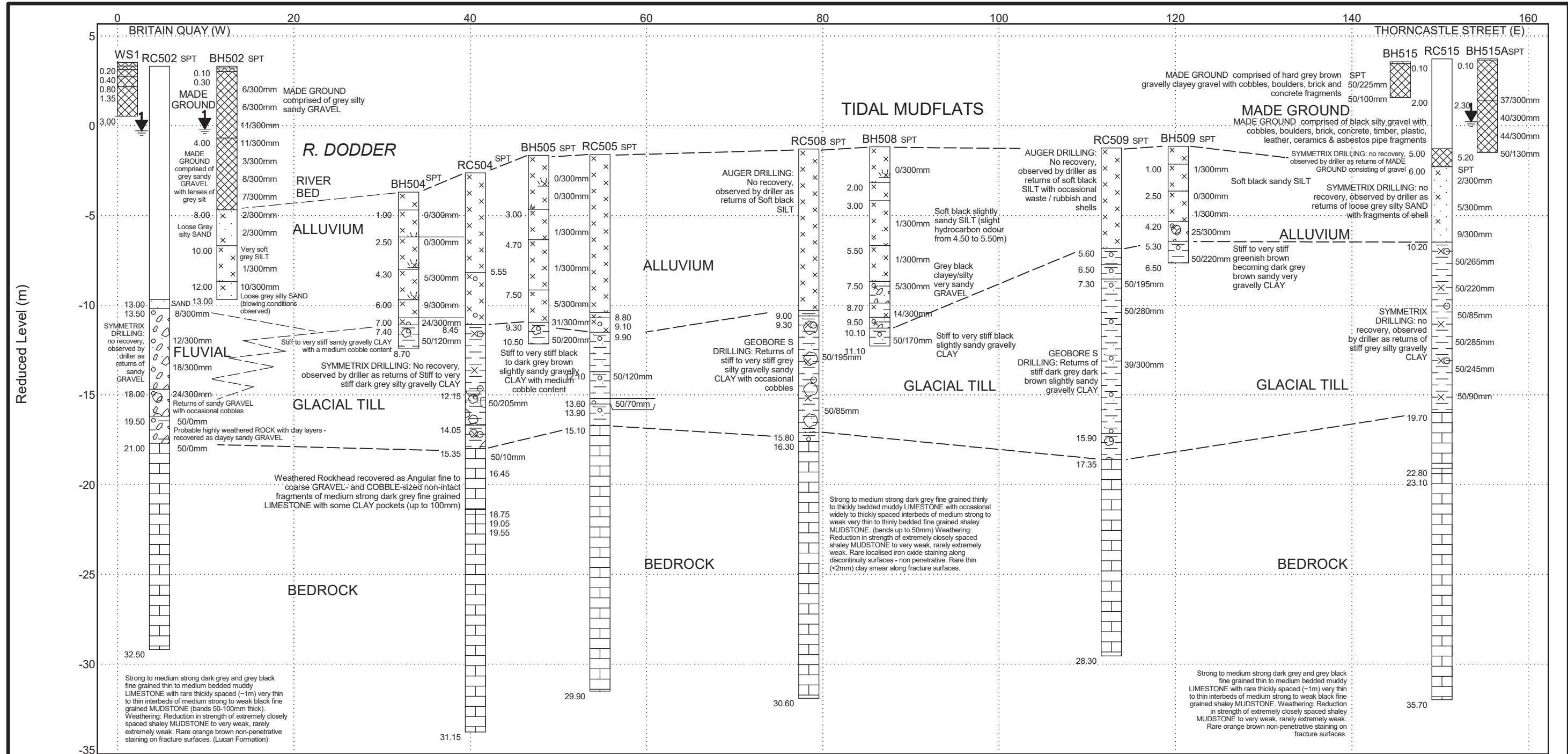

BRITAIN QUAY (W)

THORNCASTLE STREET (E)

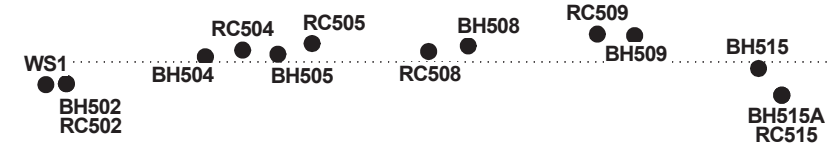

LITHOLOGY GRAPHICS

- TOPSOIL
- MADE GROUND
- Silty SAND
- SILT
- Organic SILT
- Sandy organic SILT
- Sandy gravelly organic SILT
- Sandy gravelly cobbly CLAY
- Sandy SILT
- Clayey silty sandy GRAVEL
- Clay/Silt
- Sandy gravelly CLAY
- Silty sandy cobbly GRAVEL
- SAND
- Sandy GRAVEL

SUBSURFACE SECTION South Alignment W-E

Client: Dublin City Council
 Project: Dodder Public Transport Opening Bridge Ground Investigation
 Number: 21105



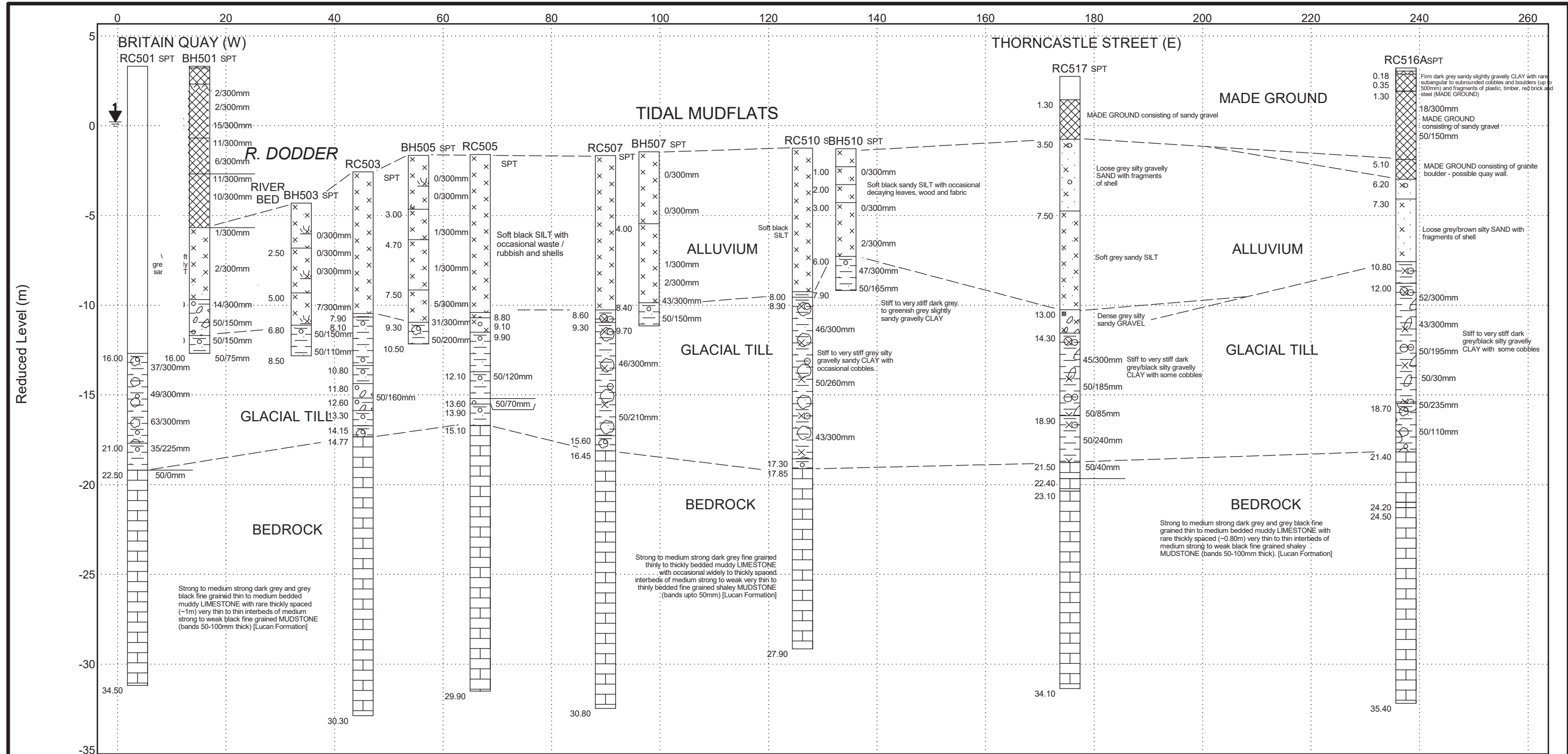

BRITAIN QUAY (W)

THORNCASTLE STREET (E)

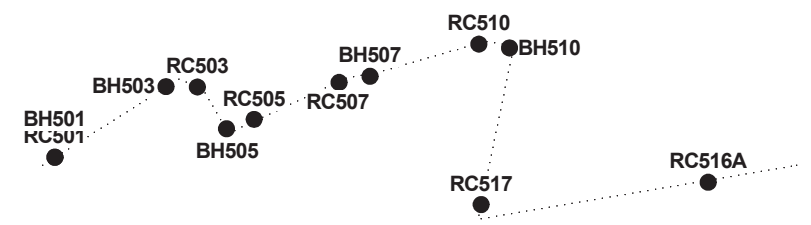

LITHOLOGY GRAPHICS

- | | | | | |
|----------------------------|------------------------------|----------------------------|--------------------|--|
| TOPSOIL | Silty gravelly sandy COBBLES | Silty organic COBBLES | Sandy GRAVEL | Sandy gravelly silty CLAY with cobbles |
| Sandy SILT | Clayey sandy GRAVEL | Sandy gravelly CLAY | Sandy organic SILT | Organic SILT |
| Sandy gravelly cobbly CLAY | SILT | Sandy gravelly cobbly CLAY | LIMESTONE | Gravelly cobbly CLAY |

SUBSURFACE SECTION North Alignment W-E

Client: Dublin City Council
 Project: Dodder Public Transportation Opening Bridge
 Number: 21105



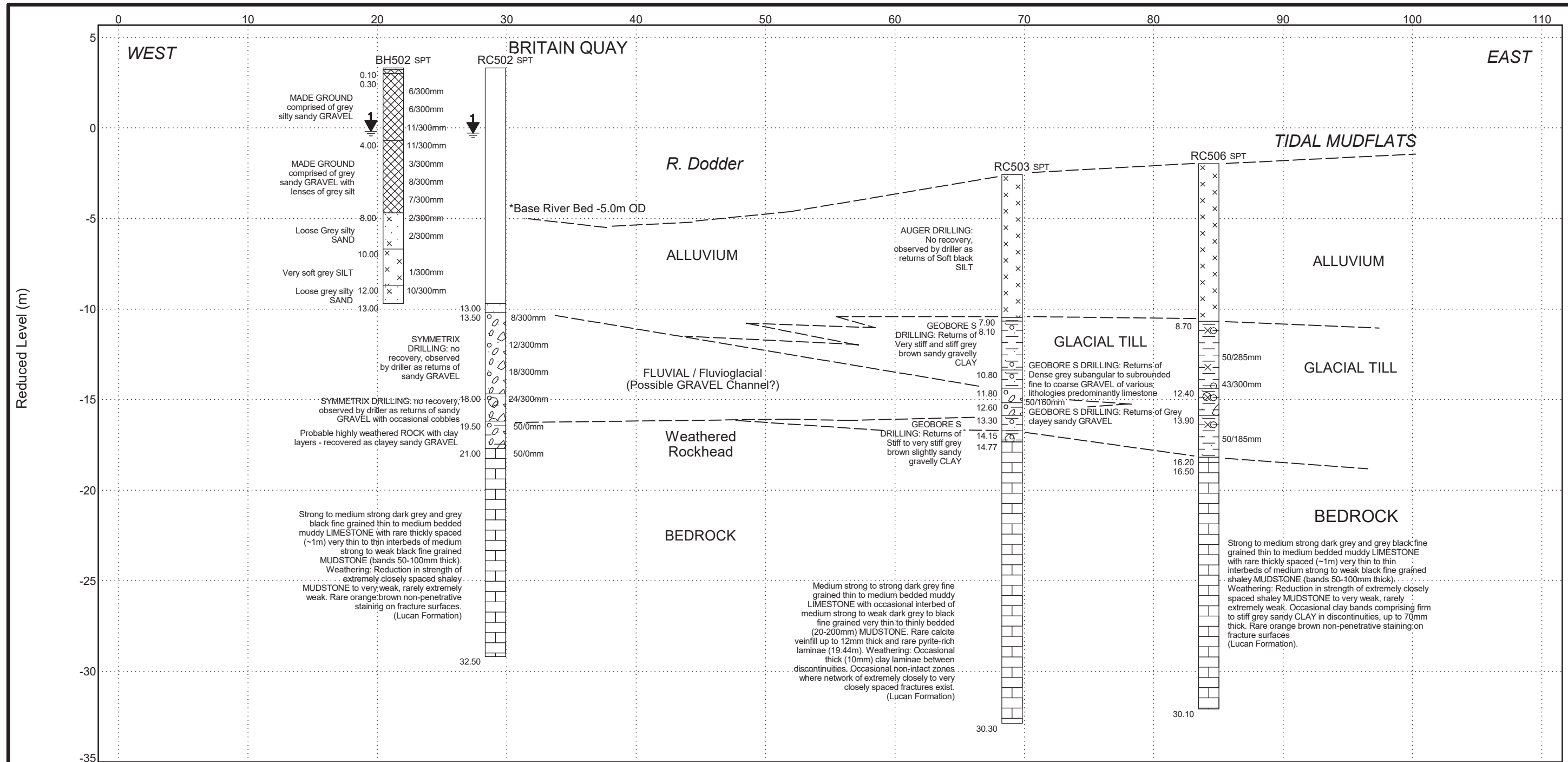

*Multibeam Bathymetric Survey indicates c. 5.0m OD base river bed in proximity to Britain Quay

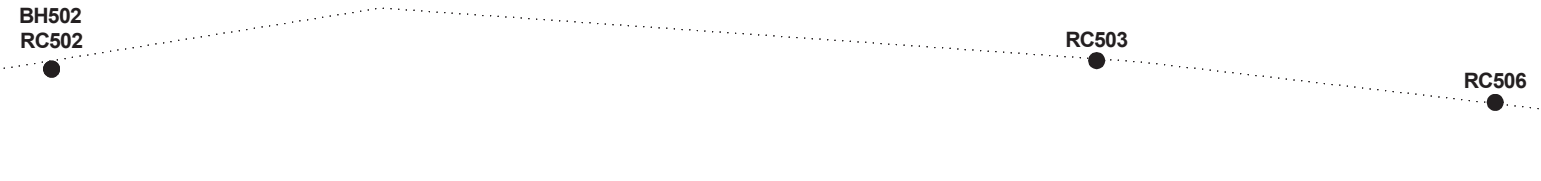

LITHOLOGY GRAPHICS

TOPSOIL	MADE GROUND	Silty SAND	SILT	SAND
Sandy GRAVEL	Sandy cobbly GRAVEL	Clayey sandy GRAVEL	LIMESTONE	Gravelly cobbly CLAY
Sandy gravelly CLAY	GRAVEL	Gravelly silty CLAY	Sandy gravelly silty clay with cobbles and boulders	Sandy gravelly silty CLAY

SUBSURFACE SECTION Possible Gravel Channel

Client: Dublin City Council
 Project: Dodder Public Transport Opening Bridge Ground Investigation
 Number: 21105



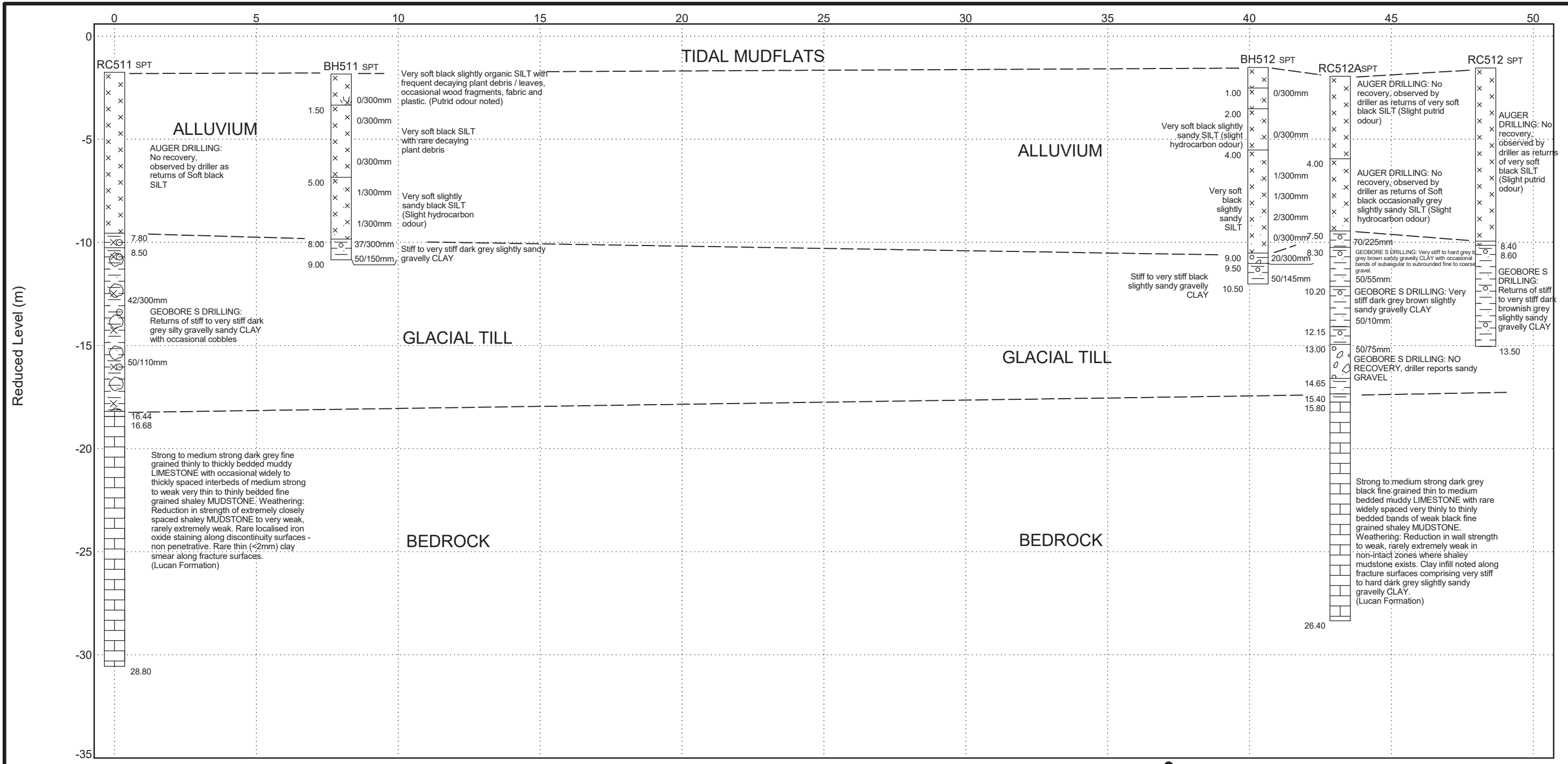

RC512A

RC511

BH511

BH512

RC512



LITHOLOGY GRAPHICS

- Organic SILT
- SILT
- Sandy SILT
- Sandy gravelly CLAY
- Sandy gravelly silty CLAY
- Sandy gravelly silty CLAY with cobbles
- LIMESTONE
- Clayey GRAVEL
- Sandy GRAVEL
- Sandy CLAY

SUBSURFACE SECTION North Shore & St. Patrick's Rowing Club

Client: Dublin City Council

Project: Dodder Public Transport Opening Bridge Ground Investigation

Number: 21105

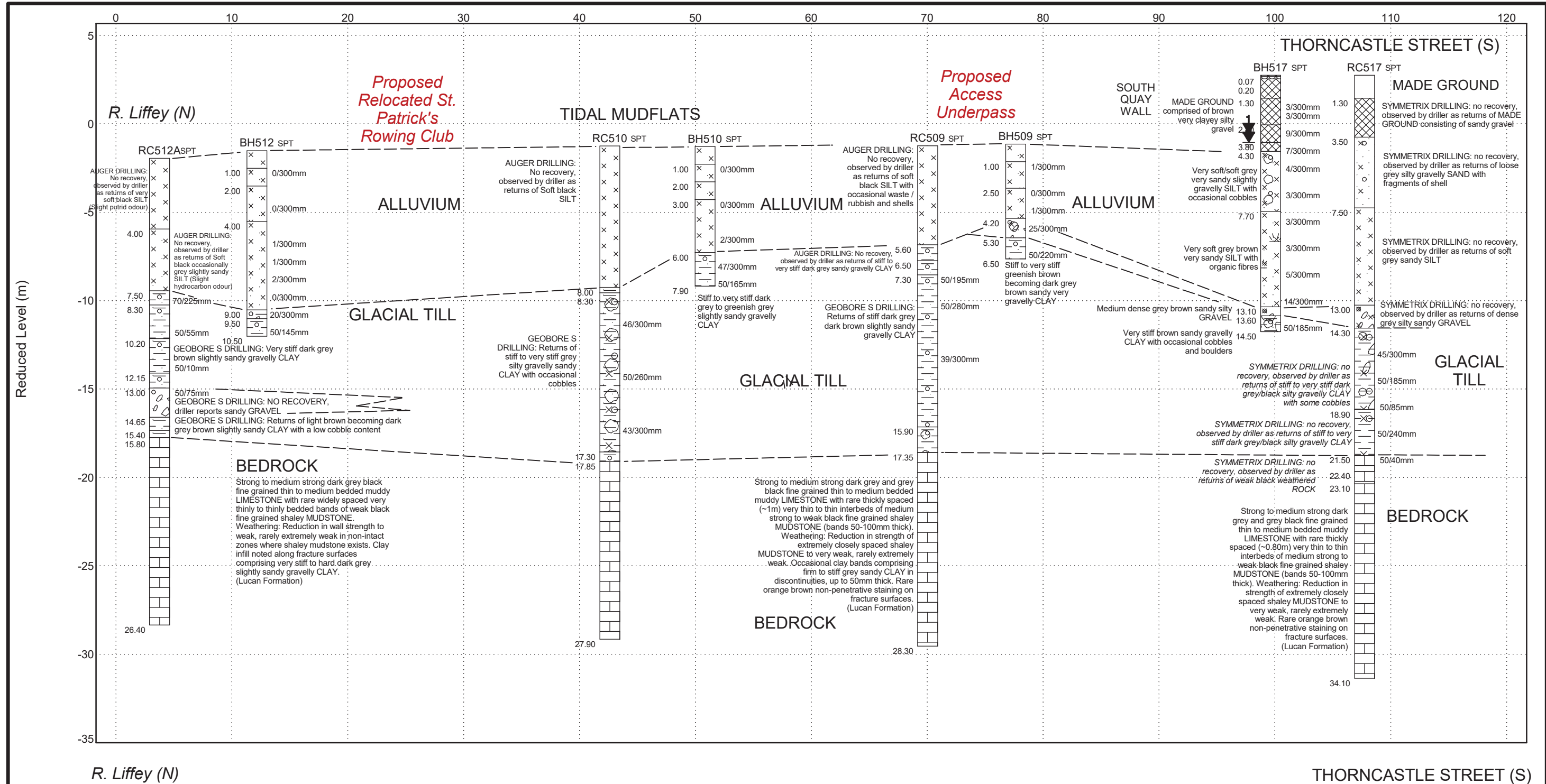

FENCE A3 CARRIGTWOHILL 21105.GPJ IGSL.GDT 10/6/20



LITHOLOGY GRAPHICS

- | | | | | |
|-------------------------------------|----------------------|---------------------------|----------------------------|--|
| Sandy organic SILT | Sandy SILT | Silty sandy cobbly GRAVEL | Sandy gravelly CLAY | Organic SILT |
| SILT | Clayey GRAVEL | MADE GROUND | Sandy gravelly cobbly SILT | Silty GRAVEL |
| Sandy gravelly cobbly bouldery CLAY | Gravelly cobbly CLAY | LIMESTONE | Sandy gravelly silty CLAY | Sandy gravelly silty CLAY with cobbles |

SUBSURFACE SECTION St Patrick's towards Access Underpass

Client: Dublin City Council
 Project: Dodder Public Transport Opening Bridge Ground Investigation
 Number: 21105

Appendix 3

Values pertaining to Concrete Aggressivity

SOIL

pH, Sulphate & Chloride contents

SOILS

		LAND BORES																			
L19/02229/IGS/001	Client Sample ID.:	BH501	BH501	BH501	BH501	BH501	BH501	BH501	BH501	BH502	BH502										
	Sample Type:	SOIL	SOIL	SOIL	SOIL	SOIL	SOIL	SOIL	SOIL	SOIL	SOIL										
	Determinand	Top Depth (m):	2-2.5	5-5.5	7-7.5	9-9.5	11-11.5	14-14.5	15-15.5	2-2.5	9-9.5										
	pH		7.6	8.3	8.2	8.7	8.2	8.2	8.6	7.9	8										
	Sulphate (2:1 Water Soluble) as SO4	mg/l	1280	984	1670	1490	1240	460	252	816	630										
	Chloride (Water Soluble)	mg/l	510	1700	2600	3500	4800	1300	470	1800	520										
L19/02284/IGS/001	Client Sample Ref.:	BH517	BH517	BH517	BH517	BH517															
	Sample Type:	SOIL	SOIL	SOIL	SOIL	SOIL															
	Determinand	Top Depth (m):	2	5	7	10	14.5														
	pH		7.8	7.9	7.9	8.2	8.2														
	Sulphate (2:1 Water Soluble) as SO4	mg/l	1450	1530	1550	1890	1340														
18-26571	Client Sample ID.:	BH503	BH503	BH503	BH503	BH503	BH504	BH504	BH504	BH505	BH505	BH505	RC505	BH506	BH506	BH506	BH509	BH509	RC509	BH518	
	Sample Type:	SOIL	SOIL	SOIL	SOIL	SOIL	SOIL	SOIL	SOIL	SOIL	SOIL	SOIL	SOIL	SOIL	SOIL	SOIL	SOIL	SOIL	SOIL	SOIL	SOIL
	Determinand	Top Depth (m):	1	2.5	7	8.9-9.3	9.3-10	2.0-3.0	6	7	2	4	8	10.7	4	8	9	2	3	11.3-11.8	1
	pH			8.1			8.6	7.7		8.1	7.9	8.1	8.1	8.5		8.5	8.4		8.4		
	Sulphate (2:1 Water Soluble) as SO4	mg/l		900			270	2200		630	1400	770	1000	260		560	970		150		
	Chloride (Water Soluble)	mg/l	5600		1200	510			6600				690	5600	5200			2400	1000	4400	
18-27684	Client Sample ID.:	BH503	BH504	BH505	BH507	BH507	BH518	BH518	BH518												
	Sample Type:	SOIL	SOIL	SOIL	SOIL	SOIL	SOIL	SOIL	SOIL												
	Determinand	Top Depth (m):	8	3	10	3	4	1	2	3											
	pH		8.2			8.1			8.1	8											
	Sulphate (2:1 Water Soluble) as SO4	mg/l	750			1200			360	690											
	Chloride (Water Soluble)	mg/l		6200	2100		5400	5500													
18-29272	Client Sample ID.:	BH508	BH508	BH508	BH509	BH508	BH508	BH508	BH510	BH510	BH510	BH511	BH511	BH511	BH512	BH512	BH512	BH512			
	Sample Type:	SOIL	SOIL	SOIL	SOIL	SOIL	SOIL	SOIL	SOIL	SOIL	SOIL	SOIL	SOIL	SOIL	SOIL	SOIL	SOIL	SOIL			
	Determinand	Top Depth (m):	1	4.5-5	6	7	6.5	8	10	1	2.0-3.0	6.5	0-1	5.0-6.0	7	2.0-3.0	6-7.2	7.2-8.5	9		
	pH		7.9		8.1	8.1		8.4	8.3	7.9	8.1	8.4	8		8.1	8	8.2	8.2	8.2		
	Sulphate (2:1 Water Soluble) as SO4	mg/l	100		20	1200		54	55	<10	21	<10	<10		<10	12	<10	<10	<10		
	Chloride (Water Soluble)	mg/l	5100	5800			5100			5100		5600	5200		5200	5300	4300	5200			
18-30527	Client Sample Ref.:	RC507	RC507	RC508	RC510	RC510	RC511	RC511	RC512	RC512	RC512A	RC512A									
	Sample Type:	SOIL	SOIL	SOIL	SOIL	SOIL	SOIL	SOIL	SOIL	SOIL	SOIL	SOIL									
	Determinand	Top Depth (m):	9.3-9.8	14.3-15.6	12.8-14.3	8.8-9.8	13.8-14.3	8.3-9.7	13.8-15.1	8.4-9.7	10-11.2	8.5-10.2	12.4-13.0								
	pH		8.7	8.8	9	8.8	8.6	8.6	8.4	8.6	8.4	8.5	8.7								
	Sulphate (2:1 Water Soluble) as SO4	mg/l	350	60	63	160	120	56	<10	14	160	390	95								
	Chloride (Water Soluble)	mg/l	1200	620	670	1200	800	1300		820	1100	1200	2500	750							

RANGE of VALUES			LAND		
OVERWATER					
pH	So4	Chloride	pH	So4	Chloride
BH504	BH510, 11 & 12	BH503	BH501	BH501	BH501
2.0-3.0	-	8.9-9.3	2-2.5	15-15.5	15-15.5
7.7	<10	510	7.6	252	470
RC508	BH504	BH504	BH501	BH517	BH501
12.8-14.3	2.0-3.0	6	9-9.5	10	11-11.5
9	2200	6600	8.7	1890	4800
	mg/l	mg/l		mg/l	mg/l

APPENDIX 4 OTHER RELEVANT DOCUMENTATION / REPORTS

ST PATRICK'S ROWING CLUB / DUBLIN CITY COUNCIL BUILDING STRUCTURAL CONCEPT REPORT

ST PATRICK'S ROWING CLUB / DUBLIN CITY COUNCIL BUILDING

STRUCTURAL CONCEPT

1. BUILDING STRUCTURE

This section describes the structural concept for the new St Patricks Rowing Club building as part of the overall Dodder Bridge Scheme.

For defining the structure, discussions have been carried out with the Design Team, in order to achieve a complete integrated design for the new St Patricks Rowing Club. In this way, architectural, mechanical & electrical and fire requirements have been considered to define the structural concept. Based on the latest architectural layouts circulated by Sean Harrington Architects in October 2019, a structural layout has been outlined for the new Rowing Club, which is described as follows.

The building is classified as consequence class *2a lower Risk Group* according to *Table 6 – Building Consequence Classes (Par. 2.2)*, included in the Building Regulations 2012 - Technical Guidance Document A. As such, the structure will be designed and constructed; with due regard collapse to engineering principles, so as to ensure that in the event of an accident the structure will not be damaged to an extent disproportionate to the cause of the damage. In this way, the provision of effective horizontal ties, or effective anchorage of suspended floors to walls for framed and load-bearing wall construction would be provided.

1.1. Building sub-structure

The future Rowing Club will be located on the north part of the reclaimed land; therefore, no additional foundation requirements are envisaged for the building structure. The building frame structure will bear directly onto the 500 mm thick nominal flat slab which is being supported by 6.0 m x 6.0 m nominal grid pile layout.

1.2. Building superstructure

Main frame

The main structure will consist of steelwork framing up to eaves level with masonry infill (cavity wall construction) and structural steelwork trusses to attain the architectural design intent. The lateral stability of the building will be achieved by means of reinforced concrete staircore and liftshaft, both of which are located in the central part of the two-storey building. The lateral stability elements will include a 215 mm reinforced concrete blade wall coincident with the 215 mm inner leaf of the east façade wall of the building.

It is proposed to adopt precast stairs and landings.

Design team coordination between the Architect, M&E and Structural has identified two options for the structural floor at first floor level. The first one consists in the use of hollowcore slab, in which the overall depth of the structural zone will be circa 825 mm (550mm deep steelwork framing members with 200 mm deep hollowcore with 75 mm thick structural concrete topping). The second option consists of lightweight trapezoidal composite slab, with in-situ concrete slab. This floor type will have an overall structural zone of circa 630 mm (470 mm steel beams depth with 160 mm overall depth composite slab). The selected option will be chosen at detail design.

Steelwork framing presents a cost-effective solution for low raised buildings with the necessity of covering relatively large spans to assist in creating the architectural requirement to provide open spaces. Such open spaces include the boat storage room, function room and the gymnasium area. It also has the advantage to

accommodate future changes if required during the lifespan of the building combined with the flexibility to accommodate vertical and lateral distribution of mechanical and electrical services. For the gym area we propose composite beam-slab construction to address potential floor vibrations associated with the gym usage

The key dimensions for the building and therefore the structure gridline has been set by the boat storage areas. The span for the main structural frames is approximately 9.00 m spanning from south to north. The structural steelwork columns are located within the 215 mm inner leaf to create flush internal wall surfaces. The main structural grid is 9.0 m x 3.0 m.

It is proposed to have the Dodder Bridge Control Building as a separate structure from the boathouse building. Again, the single-storey steelwork framed structure will bear directly onto the 500 mm thick flat slab.

Observation terrace

Along the northern part of the building an external observation terrace overlooking the river is proposed. The structure for the terrace will consist of an extension of the main structural steelwork framing elements consisting of a series of cantilever steel beams connected to the main structural frame columns. Thermal bridging at the building facade will be addressed by the provision of a suitable proprietary structural thermal-break system.

All the steel members will be grade S355JR.

External steelwork will be galvanised.

Roof structure

The roof structure will consist in a series of structural steelwork trusses located along the building gridlines. The trusses will be tied in the building longitudinal direction and plan bracing will provide the roof's longitudinal structure stability.

The function room area at first floor level requires a vaulted ceiling so an alternative structural solution involving steelwork rafters propped at ridge level will be adopted.

1.3. Loading Allowance Tables (Gravity loadings according to I.S. EN 1991-1-1:2002)

SCHEDULE 1		GROUND FLOOR LVL		
DESIGN ACTIONS:		kN/m²	kN	Category Table 6.1 EC-1
Permanent - g_k	Ground floor slab (thk. 225mm)	5.7	-	
	Services	0	-	
	Finishes	0	-	
	Non-structural screed (thk. 50mm)	1.5		
	TOTAL	7.2		
Variable - q_k	Offices (incl. 1kPa for Partitions)	4	4	B
	Corridors & stairs	5	5	C3
	Changing areas (plus 1kPa for Partitions)	5	4	C2
	Storage Areas- sports equipment	5		E1
All loads are unfactored, construction stage loading must not exceed 1.5 kN/m²				

SCHEDULE 2-A		INTERMEDIATE FLOOR - FIRST LVL (OP 1)		
DESIGN ACTIONS:		kN/m²	kN	Category Table 6.1 EC-1
Permanent - g_k	Hollow core slab (thk. 200mm)	3.1	-	B C5 C4 C3
	Structural topping (75mm)	1.9		
	Structural framing self-weight	0.3		
	Ceiling	0.25	-	
	Services	0.25	-	
	Finishes	0.25 (0.5)		
	TOTAL	6.05		
Variable - q_k	Floors (incl. 1kPa for Partitions)	4	4	
	Floors (Function room)	5	5	
	Floors (gym)	5	7	
	Corridors & stairs	5	5	
All loads are unfactored, construction stage loading must not exceed 1.5 kN/m²				

SCHEDULE 2-B		INTERMEDIATE FLOOR - FIRST LVL (OP 2)		
DESIGN ACTIONS:		kN/m²	kN	Category Table 6.1 EC-1
Permanent - g_k	Composite deck (thk. 200mm)	3.56	-	B C5 C4 C3
	Structural topping (75mm)	-		
	Structural framing self-weight	0.3		
	Ceiling	0.25	-	
	Services	0.25	-	
	Finishes	0.25		
	TOTAL	4.61		
Variable - q_k	Floors (incl. 1kPa for Partitions)	4	4	
	Floors (Function room)	5	5	
	Floors (gym)	5	7	
	Corridors & stairs	5	5	
All loads are unfactored, construction stage loading must not exceed 1.5 kN/m²				

SCHEDULE 3		OBSERVATION TERRACE- FIRST LVL		
VERTICAL LOADINGS				
DESIGN ACTIONS:		kN/m²	kN	Category Table 6.1 EC-1
Permanent - g_k	Composite deck (thk. 200mm)	3.56	-	
	Structural topping (75mm)	-		
	Structural framing self-weight	0.3		
	Finishes	0.25		
	TOTAL	4.11		

Variable - q_k	Terrace (susceptible to crowds)	5	5	C5
	Stairs	5	5	C3
All loads are unfactored, construction stage loading must not exceed 1.5 kN/m²				
		HORIZONTAL LOADINGS		
		kN/m		
Variable - q_k	Horizontal loads on parapets $h < 1.20m$, For terrace Category C5	3.0		T. NA.5 EC2 6.12
All loads are unfactored, construction stage loading must not exceed 1.5 kN/m²				

SCHEDULE 4	EAVES LVL			
DESIGN ACTIONS:		kN/m²	kN	Category Table 6.1 EC-1
Permanent - g_k				H -
	Structural framing self-weight (steel)	0.3		
	Services	0.5	-	
	Ceiling	0.25	-	
	Water tanks [assume 1.5 m height of water] - TBC	15.0		
Variable - q_k	Maintenance	1.5	-	
All loads are unfactored, construction stage loading must not exceed 1.5 kN/m²				

SCHEDULE 5	ROOF LVL			
DESIGN ACTIONS:		kN/m²	kN	
Permanent - g_k				Table 6.10 (H)
	Steel self-weight	0.4		
	Insulation	0.1		
	Services	0.25	-	
	Ceiling	0	-	
	Roof sheeting	0.25		
Variable - q_k	Roof	0.6	-	
All loads are unfactored, construction stage loading must not exceed 1.5 kN/m²				

1.4. Applicable Design Codes

- IS EN 1990: Eurocode: Basis of Structural Design
- IS EN 1991: Eurocode 1: Actions on Structures
- IS EN 1992: Eurocode 2: Concrete
- IS EN 1993: Eurocode 3: Steel
- IS EN 1994: Eurocode 4: Composite steel and concrete structures
- IS EN 1995: Eurocode 5: Timber

- IS EN 1996: Eurocode 6: Masonry
- IS EN 1997: Eurocode 7: Geotechnical Design

1.5. Designing for Expansion – Structural Implications

No allowance for future lateral or vertical expansion is made.

Allowance will be accommodated in the design for possible future access to the roof of the Control Room building from the first floor function room.

1.6. Design working life

The building structure is classified as design working category 4 according to table NA.1 of the Irish National Annex to Eurocode - Basis of structural design [I.S. EN 1990:2002]. Consequently, all structural elements shall have a design working life of at least 50 years.

1.7. Non-structural requirements

1.7.1. Fire requirements

A fire safety certificate shall be obtained for the building from the local fire officer (Dublin City Fire Brigade) in accordance with standard practice.

1.7.2. Cladding

The building is clad in red facing brick, reflecting the Victorian buildings along the north and south quays, the industrial buildings of Grand Canal Dock, and the newer residential buildings adjacent on York Road, Thorncastle Street and Capital Dock. This is a robust material, that will weather well in this exposed location.

1.7.3. Roofing

The pitched roof is covered with a pre-patinated copper standing seam roof, echoing an upturned copper-bottomed boat, emphasising the maritime heritage of the area. It will be visually distinctive and become a landmark. The pre-patinated copper will weather well in this exposed location, maintaining its initial colour and texture.

1.7.4. Drainage

A sustainable urban drainage strategy is proposed for the site. Rainwater goods for the building will be pre-patinated copper to match the roof, and aluminium.

1.7.5. Windows

Windows are triple glazed timber alu-clad. An appropriate external RAL colour will be selected to complement the facing brick cladding. The size and proportion of the glazed sections will be developed at the next stage in consultation with the Mechanical and Electrical Engineer to maximise views, cross ventilation and natural daylighting, while avoiding overheating.

1.7.6. Insulation

The proposed cavity wall construction allows for full fill rigid insulation to all walls. A layer of insulation is fixed to the ceilings of ground floor stores. This insulation will preferably have fire protection performance. During the next stage of design it will be established whether a warm or cold roof is used. The heated areas of the building meet NZEB levels, as is now required by the Building Regulations.

1.7.7. Lighting spec – internal and external

All lighting fixtures are high efficiency LED lighting. Internal lighting is provided in accordance with the Light and Lighting Code of Practice CIBSE Code L: 2018 in

accordance with EN Light Regulations including, EN 62722-2-1: 2016 and IEC 62717:2014.

The external lighting will be coordinated with the Architect and the Landscape Consultant's aesthetic requirements.

1.7.8. Balcony handrail

The balcony handrail will be 1125 mm above finished floor level in compliance with TGD Part K, formed with marine grade stainless steel flat frame and uprights.

1.7.9. Finishes at handover

It is understood that all floor, wall and ceiling finish will be installed and complete at handover stage. In addition WCs will be fitted out with sanitary-ware, and the changing rooms and kitchenette will have appropriate fitted furniture installed. For the function room, we will indicate a possible location for future bar counter, however this will not be included under this contract.

1.7.10. Maintenance access to roof and other elements

All flat roof will be accessible for maintenance with a railing. Brick and copper are robust materials which will need little maintenance.

1.7.11. Services required

The various utility companies i.e. Gas Networks Ireland, ESB Networks and Communications (Eir/Virgin Media) will be contacted to discuss the availability of utility services to the proposed site location.

There will be design team coordination with all relevant utilities i.e. ESB, Gas Networks Ireland and Eir to ensure adequate ducts/pipes are facilitated for the site. There will be diversions required on the existing site utility services and this will be coordinated with the Civil Engineer and Assigned Certifier.

1.7.12. Inclusivity (Part M)

The proposed lift installation may consist of a platform type in compliance with Part M of the Building Regulations. Suitable communications will be provided within the lift and integrated with the fire management cause and effect matrix. This will be developed during the detailed design stage.

1.7.13. M&E

All of the new mechanical and electrical services for the proposed new development at St Patrick's Rowing Club will be designed in accordance with all relevant codes of practice and standards (EN/IS/BS).

The mechanical and electrical services will be designed in accordance with IS 399 Energy Efficient Design in conjunction with Part L Building Regulations NZEB and relevant Guidance Documents.

The target Building Energy Rating is A.

A sustainable design approach and strategy for the mechanical and electrical services would be adapted during the design development to achieve a low carbon building that will also have a low running and operational cost.

To this end a number of sustainable and renewable energy systems will be assessed for their suitability for use in the building, including:-

- Heat pumps – air to water
- Solar photovoltaic (PV) energy solutions
- Mechanical heat recovery ventilation (MHRV);
- Variable speed demand controlled pumps and fans
- High efficiency LED lighting (see 1.1.7 above)
- Metering of mechanical and electrical systems for measuring and recording

APPENDIX 5 MEICA TECHNICAL DETAILS

1. GENERAL DESCRIPTION OF MECHANICAL AND ELECTRICAL INSTALLATION

1.1. Proposed Mode of Operation of Structure

The proposed movable structure will be a new opening single leaf bascule bridge.

The bridge is to be a single leaf bascule bridge of the "integral trunnion type", providing a 19m clear navigational channel. An unlimited air draft is to be provided across this span with the movable span in the fully raised position.

Design is such that the roadway joint at the bascule span/bascule interface is small enough that a vehicle cannot fall through the opening with the leaf in the open position – in this case a resistance barrier gate is not required at this location.

The bascule spans are raised and lowered by a pair of hydraulic cylinders configured in an extend to raise arrangement. The hydraulic cylinders are to be mounted in the bascule counterweight chamber located to act forward of the trunnion bearings (toward the toe of the bridge).

In the closed position the bascule span is simply-supported on the trunnion bearings at the centre of rotation and on the live load bearings (live load shoes) located on the abutment. Counterweight mass is contained within the heel of the bridge leaf integral with the bridge leaf box girders and steel counterweight box.

Live load bearings ('live load shoes') are to be positioned near the tip of the bascule span, forward of the trunnions and underneath the upstand box girders. In the bridge-lowered position, and in combination with the bridge trunnions, these support the dead and live loads of the bridge. Live Load Bearings include a cylindrical load shoe to accommodate local deflections.

Nose locks are specified at the west abutment, with a receiving socket mounted on the tip of the bascule leaf, to secure the leaf in the closed position and provide a physical interlock to prevent inadvertent operation or rotation of the leaf due to the operating system or live loads acting on the deck rear of the trunnions.

The bridge leaf shall be lifted to its raised ("open to marine traffic") position by hydraulic cylinders operating at a maximum hydraulic pressure of 250 bar. Each leaf will rotate about the trunnion axis through an angle of approximately 70° to provide a clear unrestricted air-draft over the navigational width of 19m.

The bridge trunnion assemblies are connected to the bascule girders (upstand box sections) by bolted and/or mechanical interaction with the longitudinal vertical web plates of the torsionally-stiff box girders. The steel tube of the integral trunnion is connected to both the hydraulic cylinder upper clevises and the box girders to interconnect the two box girders and transmit cylinder forces due to operating and wind loading. Trunnions are designed to support the dead load of the bascule span plus 20 percent during operation. Trunnions are also designed for the maximum live load service load conditions and fatigue loads per EN 1991 and as specified in Section 6 of the main body of the PDR.

Main girder webs shall be machined at the interface with the trunnion assembly. The web faces shall be milled to a flat surface, perpendicular to the trunnion axis. The webs shall be bored for an interference fit with the trunnion hubs. Flatness, perpendicularity, dimensional tolerances and surface finishes shall be per the AASHTO LRFD Movable Highway Bridge Design Specifications.

The hydraulic circuit design will allow the bridge to be operated at a reduced wind speed in the event of a failure of one hydraulic cylinder. Under the accidental condition of the failure of one hydraulic cylinder, the operating pressure in the remaining hydraulic circuits will not exceed the relief valve setting, 250 bar.

The hydraulic cylinders shall be capable of acting in both compression (extending) and tension (retracting) depending upon the direction of action and the applied loads, and able to dynamically modulate between these two modes during the raising or lowering of the bridge deck.

An open-loop hydraulic system will control motion of the bridge. Overhauling loads will be resisted by system counterbalance valve(s) arranged such that they are common to the flow from both cylinders (i.e. counterbalance valves are not mounted on the individual cylinders). The HPU is to be designed with redundant pump/motor groups such that with one group removed from service the bridge can be operated at approximately half speed at the full design wind velocity. Design using positive displacement axial piston pumps.

Design to provide pressure limits in the hydraulic system including adjustable pressure relief valve(s) to control the operating pressure in the circuit and non-adjustable pressure relief valve(s) with maximum pressure protection to limit the maximum possible pressure in the system regardless of field adjustment of other relief valves.

The hydraulic power unit is designed to include the following features:

- Pressure and return filters
 - Off-line Fluid conditioning circuit with filtration, heat exchanger and heater, capable of running independent of the main pumps
 - Accumulator(s) and Uninterruptable Power Supply(s) to provide momentary control pressure and electrical power to hold cylinder pilot operated check valves and main directional valves open until the counterbalance valves gradually close and bridge the leaf to a controlled stop in the event of an emergency stop or sudden loss of power

The calculated cycle time under the average pressure conditions is 90secs to raise and 90secs to lower (see section 3.1). Average pressure is defined in Table 13 of BS 6786-1. Under maximum operating pressure conditions, the time to raise or lower is not to exceed 180 secs. The exact power requirements will depend on the final geometry and the degree of counterweight employed. Nose lock operation is 6-9 seconds to drive or retract locks under any design load condition.

1.2. Location of Operating and Control Mechanism

In addition to the lifting cylinders described in section 1.1, other M&E equipment are described as follows:

The bascule leaf is mounted on trunnion bearings located in the bascule pier. Trunnion bearings are of the plain spherical type capable of resisting vertical and horizontal loads associated bridge operation and traffic loading combinations. Trunnion bearings are also capable of accommodating deflections of the trunnion shaft as may occur under various loads and load combinations. One bearing is to be configured as laterally fixed and the other configured to allow lateral expansion. Design trunnion bearings with plain bearing elements or bushings of the spherical type equipped for lubricated operation (not maintenance free).

Electrically-actuated nose lock assemblies are incorporated into the west abutment and engaged in a receiver at the toe of the bascule leaf. . The nose locks consist of a forged steel bar supported by a forward and rear guide on the abutment or bascule leaf and actuated to engage a corresponding receiver on opposite side of the joint. Guides and receivers are equipped with shims to allow for initial adjustment and compensation of wear in the guide and receiver bushings. Linear electric actuators will be utilised to engage and disengage the nose locks.

Design hydraulic cylinders for span actuation for the following.

- Type: mill duty, welded body construction
- Mounting: spherical bearing or equivalent at each connection to relieve side loading; spherical bearings to include standard internal seals as well as secondary external seals to prevent saltwater and debris from contaminating the bearing

Design cylinders with manifolds hard piped to the cylinders and including the following functions:

- Direct operated, externally drained, pilot operated relief valves for holding when not actuated
- Factory set, tamper resistant pressure relief valves
- Manual needle valves configured to allow release of the cylinder pressure (freewheeling) with return of excess fluid to the reservoir
- Anti-cavitation/drain line from cylinder manifolds to HPU

Hydraulic cylinders will be equipped with adjustable cushions located at the rod and blind end. Cylinder cushions will be designed, fabricated and adjusted to prevent hard seating of the bascule leaf in the event of seating control failure.

To raise the leaf, the nose locks are firstly withdrawn, and the cylinders are then actuated. In the lowered position, a preponderance exists to provide a continuous positive reaction on the live load shoes to minimise bouncing of the bridge leaf. The nose locks are designed to hold the bridge tip seated firmly on the live load bearings. Design will accommodate sufficient force to seat both live load bearings under all temperature differential conditions, plus a deck fabrication twist tolerance of $\pm 3\text{mm}$ at each live load bearing. Nose locks shall also be capable of resisting 100% of the full force of the hydraulic cylinders in the event they are inadvertently actuated with the locks engaged.

Travel-limiting stops shall be provided within the piers and cushions provided on the blind end of the hydraulic cylinders to mitigate against the spans over-turning, caused by excessive wind loading. The stops shall prevent the bridge leaves travelling beyond their intended range. These travel-limiting stops plus maintenance locks shall receive and hold the span in the raised position.

The maintenance locks (holding device) shall be designed considering the maintenance requirements of the bridge in its open position, the length of time the bridge is expected to remain in that position in the likely wind conditions which could be expected to occur during that time.

A Programmable Logic Controller (PLC) control system with an emergency relay backup operation is to be provided. Primary operation will be from a control desk located in the control building. A local means of maintenance operation is to be

provided in the bascule pier. The PLC will be designed to consider future remote control.

Linear position sensors installed in the cylinders or rotary sensors connected to the trunnion shaft will monitor the position of the bascule leaf during raising and lowering. Rotation of the span as measured by these devices, will be the primary method of controlling bascule span position. A redundant system such as an inclinometer or absolute digital encoder will be used as a backup should the primary sensor fail.

Proximity type limit switches will be used by the PLC program to check position of the span at the extents of travel. A fully lowered and fully raised switch and a nearly lowered and nearly raised switch will be included. The nearly lowered and nearly raised switches will be used to determine the zones of travel where deceleration is to take place.

For the fully lowered position, a method of firmly seating the bridge against the live load supports will be programmed by continuing to hold reduced pressure at the cylinder rod end ports for several seconds after the fully lowered switch has been detected. This will assure that the movable span is firmly seated before the nose locks engage.

Pedestrian and vehicle control barriers will be located across the carriageways and footways/cycle paths on both the East and West approaches. These barriers will control traffic and pedestrian access onto the bridge just before and during bridge movements. In addition, wig-wag warning lights and sounders will be provided for vehicle control; warning lights and sounders for pedestrian control

Pedestrian barriers are located across the pedestrian/cycleways on both the bridge approaches. These barriers prevent pedestrian access onto the bridge just before and during bridge movements. In addition, warning lights and sounders are provided for pedestrian control.

The barriers are located such that the waiting public are maintained at a safe distance from the moving components at every stage of the bridge movement sequence.

1.3. Electrical Power Supply and Distribution

A 3-phase, 275 kVA, 400V power supply is required for the control cabinets and plant room, situated within the bascule pier. The utility power supply value will be based on the calculated lift cylinder loading and plant/control room power requirements.

The distribution panels in the plant room will provide for:

- Main hydraulic power units.
- Control system PLC.
- Bascule pit drainage pumps.
- Traffic and Pedestrian gates and wig-wags.
- CCTV System.
- Marine navigation lights.
- Lighting, Ventilation.
- Low voltage power.
- Pedestrian warning lights

The bridge control system including communications, field devices, and E-Stop circuits will be designed to Safety Integrity Level (SIL) 2 as per BS EN 60204 and/or performance level 'C' as per BS EN 13849.

1.4. Stand-by-power facilities (UPS etc)

Stand-by-Power facilities are not required. A generator receptacle will be provided to allow for a mobile unit to be provided and operate the span.

1.5. Design working life, whole life and sustainability considerations

The bridge shall be designed for an average of 70 operations (an operation being defined as an open and close cycle) per year, a maximum of 4 operations per day, with availability every day of the year with a maximum short-term frequency of two operations per hour. The M&E equipment will be designed for the following life (subject to regular preventative maintenance and inspection):

Table 1.1 Design Working Life

Steel machinery elements (cast or forged)	120 years
Trunnion shafts	120 years
Trunnion bearings or bushings	50 years
Nose lock bushings	25 years
Nose lock bars	50 years
HPU Components:	
• Fabricated components	50 years
• Manifold blocks	50 years
• Valves	25 years
• Seals, gauges	15 years
• Hydraulic Piping	50 years
• Hydraulic Hoses	15 years
Hydraulic Cylinders for Actuation	
• Body, rod, piston, hardware	50 years
• Seals, wear elements	25 years
• Spherical bearings	25 years
Fabrications for the mechanical components	120 years
Electrical equipment	15 years
Corrosion protection system	25 years

Sustainable decisions made during the design process will have a positive impact on the cost and carbon footprint of the scheme. To support sustainable construction and whole life costing, the following principles have been embedded in the design:

- The bascule span will be optimally balanced with the aim of minimising up-front construction materials while increasing long term operational efficiency. The efficiently balanced spans will require less power to operate; thereby, reducing the size and scale of the installed MEICA components and their maintenance while reduce operational running costs and power requirements.
- The structure shall be designed for minimum waste optimising steel sections with their load demands.
- The counterweight shall be comprised of a steel box with concrete infill. A staged pour sequence is proposed to reduce steel plate thickness. Heavyweight

concrete or a combination of normal weight concrete and steel or lead ballast is used to increase density and reduce the overall volume of the counterweight.

- In the case of future unplanned retrofits to structure, void allocation and removable blocks within the counterweight will be provided to accommodate span rebalancing with minimal disruption and reconstruction to the deck over counterweight and plant room. Voids shall be sufficient to accommodate a 3.5% underrun of the required counterweight mass to a 5% overrun of the required counterweight mass.
- The mechanical equipment shall be designed with the aim of minimising maintenance and adjustment requirements. Where practical, mounting bearings shall be specified as maintenance-free.
- Emergency power requirements have also been modified to reduce the size of the back up diesel generators, thereby limit size and cost of the generators themselves and the required amount of stored fuel over the life of the bridge.

The designs will be optimised to minimise the use of materials, energy (particularly the energy required to raise and lower the bridge) and labour to achieve a minimal disruption or degradation of the natural environment.

2 OPERATIONAL DESIGN CRITERIA (AS RELEVANT)

2.1 Variable actions

Refer to Section 6 of the main body PDR for full details.

M&E systems are to be designed for SLS state. The following factors have been applied for determination of loads on the M&E systems:

Table 2.1 Limit State Factors

	SLS	ULS	Combination factor
Deck Load	1.1	n/a	n/a

The design of the hydraulic lift cylinders, together with their corresponding support systems, shall incorporate a factor of 1.1 to allow for tolerances in relief valve settings. Buckling factors shall be taken as 3.5 for hydraulic cylinders.

2.2 Traffic actions

Refer to Section 6 of the main body PDR for full details.

2.3 Snow actions

Refer to Section 6 of the main body PDR for full details, however snow loading shall not be ignored for the M&E equipment design.

2.4 Wind actions

The design wind speed for actions on the mechanical components shall be applied using the Dutch Standard BS 6786-1, 2017. Design the hydraulic system and structures loaded by the action of hydraulic actuators for loads and pressures determined applying BS 8676, Dutch Moving Bridge code using the following:

Wind Field Zone (base wind speed), $V_{b.0} = 24.5\text{m/s}$

Type of Waterway - Main Waterway

Hours per year inoperable due to high winds = 72

Design the holding device for the above requirements assuming the minimum duration factor. Wind loading for single cylinder operation is to be based on the wind loads associated with 168 hours per year inoperable due to high winds. Single cylinder operation is identified as a Manual Maintenance Mode. See Section 3.1.1.

In designing for single cylinder holding, with the leaf in the open position and the wind applied to the underside (wind action opening the bridge) the pressure in the rod end of the cylinders may exceed the cylinder relief valve setting, allowing the leaf to rotate until the span rests firmly against the bumper blocks.

2.5 Thermal actions including temperature range

Refer to Section 6 of the main body PDR for full details.

2.6 Any special actions not listed above (e.g. ship impact).

The M&E systems shall be designed to accommodate failure of one hydraulic lift cylinder, such that the bascule span can continue to operate at a reduced wind speed without damage to the structure and associated M&E equipment, albeit possibly at a reduced speed and/or wind loading, in order to recover the bridge to the closed position. This requirement will be accommodated by either disconnecting one cylinder

or by allowing the fluid to free cycle in one cylinder. Further operation following a failed cylinder will be permitted only to place the bridge leaf into a position necessary for the repair or replacement of the failed cylinder or if continued operation has been deemed not to be to the further detriment of the failed cylinder or to the integrity of the serviceable cylinder(s) and their associated structural attachments.

2.7 List of Relevant Safety Consultation documents

2.7.1 Additional Relevant Standards and Publications

Mechanical Systems

- BS 2573 Rules for the design of Cranes, Parts 1 (structures) and 2 (mechanisms) Based on the average number of openings per year and the operating time, and the Class of Utilisation of the mechanisms.
- Dutch Moving Bridge Code (BS 6786-1:2017).
- AASHTO LRFD Movable Highway Bridge Design Specifications 2nd Edition 2007.
- The Machinery Directive 2006/42/EC and referenced standards including the requirements for preparing a CE mark for the equipment.

Electrical Systems

- The Machinery Directive 2006/42/EC and referenced standards including the requirements for preparing a CE mark for the equipment.
- Low Voltage Directive (Electrical Equipment Safety Regulations)
- IS 10101:2020 " National Rules for Electrical Installations", 18th Edition
- IS EN 62305-1 :2011, Protection against Lightning, General Principles
- IEC 61439 'Low-voltage switchgear and controlgear assemblies'

Control System

- IEC 60204-1 / EN 60204 Safety of machinery – Electrical equipment of machines – Part 1: General requirements
- Control System In accordance with best and current practice and tested in accordance with a Failure Mode and Effects Analysis (FMEA) and Hazard and Operability Study (HAZOP).

Hydraulic Systems

- EN ISO 4413:2010 – Hydraulic Fluid Power - General Rules and Safety Requirements for Systems and their Components.

2.8 Proposed departures relating to Departure from Standards given in 2.7 and

2.7.1

Machinery components will be designed per the AASHTO LRFD Movable Highway Bridge Design Specifications 2nd Edition 2007 and checked for conformance with BS 2573 Rules for the design of Cranes, Parts 1 (structures) and 2 (mechanisms).

2.9 Proposed departures relating to methods of dealing with aspects not covered by 2.7 and 2.7.1

None anticipated.

3 BASIS OF OPERATION AND CONTROL

3.1 Normal Operating Conditions

The cycle times to open and close the bridge will be as shown on the table below. The bridge will be controlled via the control room in the new St. Patrick Rowing Club / Dublin City Council building.

Table 3.1 Operational Cycle Times

Phase	Duration (sec)	Cumulative Time (sec)
Opening		
Vessel requests bridge opening	0	0
Alarm/wigwag light signals start	20	20
Entry Barriers drop, and traffic entry stops	5 ¹	25
Exit Barriers drop	5 ^{2,3}	30
Nose lock retraction	10	40
Bridge lifts open	90	130
Closing		
Vessel has cleared to bridge	0	0
Bridge lowers	90	90
Nose lock insertion	10	100
Pedestrian barrier operation prestart warning	5	105
Lights/alarm stops, all barriers lift	5 ¹	110
Traffic resumes	0	110

Note 1 – Barrier operating times are generally adjustable in the range of 2-7 seconds and should be set during commissioning to the lowest practical value.

Note 2 – Pedestrian barriers/gates may not necessarily operate simultaneously with vehicle barriers. No allowance is given in the table above for NMU (non-motorised unit) clearance times.

Note 3 – Vehicle clearance time monitored by bridge operator before closing exit barriers.

3.1.1 Modes of Operation

The bridge is designed to operate in two basic modes:

- Automatic Mode – Step by Step Control by Operator.
- Manual Maintenance Mode – Step by Step Control by trained maintenance operator without protective sequence interlocks.

3.1.1.1 Automatic Mode (Step by Step Control)

In this mode, the bridge is operated from the Operator's control desk located in the control room. This mode of operation has the following features:

- Operated by a competent person, trained in the operation of the bridge
- Other competent and trained personnel (e.g. maintenance staff) may be required to assist the Operator with bridge operations
- Each sequence of bridge operation is controlled by a separate push button laid out in a logical manner on the control desk simulating the correct order of operation
- Protective interlocks are still active

3.1.1.2 Manual Maintenance Mode

In this mode, the bridge is operated from the Operator's control desk located in the control room. This mode of operation has the following features:

- Operated only by a competent person, trained in the operation of the bridge in manual/maintenance mode. Switching to this control requires additional authorizations
- Other competent and trained personnel (e.g. maintenance staff) may be required to assist the Operator with bridge operations
- Each sequence of bridge operation is controlled by a separate push button laid out in a logical manner on the control desk simulating the correct order of operation
- Protective interlocks are not active and do not therefore enforce the correct sequence of operation.
- Single cylinder operation is to be performed only in Manual Maintenance Mode, with the bridge speed reduced to no more than half normal full speed and a trained maintenance person positioned near the hydraulic system to observe operation. An anemometer shall be used to assure single cylinder operation is only performed with wind velocities at or below the value for which single cylinder operation has been designed.

3.1.2 Emergency Operation

This mode is entered any time the Operator considers a situation has arisen which may, under the bridge Standard Operating Procedures (SOPs), constitute an emergency. Under these circumstances all motions of the bridge and its mechanisms must be halted.

Emergency stop pushbuttons will be located on the operator control desks, on each plant room control panel and on each hydraulic power unit.

When activated, the bridge and its mechanisms will stop in a controlled manner under the actions of the hydraulic system.

The action of releasing an Emergency Stop Button will not automatically reset the system.

The bridge will be provided with a remote access point to allow fault diagnosis and to review other movable bridge equipment through the HMI/SCADA data remotely.

Consideration, at the detailed design stage, will be also be give to separate emergency stop procedure which will stop and reverse the barriers that would not necessarily trigger a full emergency mode described above.

3.1.3 Manual Emergency Operation

Manual emergency operation will be subsequently allowed and limited to returning the bridge to the closed position should the control system and all associated equipment fail.

3.1.4 Operation under Supply Fault Conditions

In the event of complete power failure of the incoming supply, the bridge will be provided with a generator receptacle that will allow a full-sized mobile diesel generator to be connected and allow span operation.

The generator receptacle will be located at the face of the control house.

3.1.5 Operation under Reduced Number of Actuators

Under the accidental condition of the failure of one actuator, it will be possible to recover the bridge to the closed position using the remaining actuator(s).

The bridge shall not be opened under the accidental condition of the failure of more than one of the actuators unless the bridge is operated in an emergency/maintenance mode. This requirement will be incorporated into the fault condition monitoring and PLC control of the bridge and will also be clearly described in the O&M manual. The subsequent emergency methods of operation under actuator failure conditions shall be only possible at reduced operational speeds and reduced operational wind speeds.

3.1.6 Bridge Operating Sequence

The bridge control system is designed so that a single operator can open and close the bridge from controls located on a control desk in the operator control room and assisted by a touch screen HMI and CCTV.

The bridge is provided with its own power and control system located in the bascule pier. The operator house side building control room has a clear view to the approach roadway and waterway. CCTV screens assist the operator to view the East and West approach roadways.

At any time, the operator can stop the bridge moving by pressing the stop button which does not stop the HPU but stops the bridge sequence. The operator can then continue with bridge operation to open or close the bridge.

If an Emergency stop pushbutton is pressed, then all systems stop including the HPU and the navigation lights change from green to red. If the traffic and pedestrian control barriers are lowered, they remain in that position until the system is restarted. To continue with bridge operations the operator must release the emergency stop, reset the system and restart the bridge sequences.

3.1.7 Opening Sequence

The following opening sequence is based on bridge control from the operator control desk:

- The operator inserts a key in the 'control desk power' key-switch and energizes the control system.
- The operator then logs into the HMI and checks system availability to check all required devices are not in fault and available ready to run. Sequence will not move forward from this point if the available check fails.
- Wind Speed and direction is also checked. If wind speed is above the limit at which the bridge can open safely, the bridge stays closed. If the wind speed is within acceptable limits, the operator continues with bridge operations.
- The operator starts the Hydraulic Power Units (HPU) by pressing the appropriate buttons on the control desk. Buttons are fully lit when the HPUs are running unloaded. The priming pumps will start and circulate oil to the bridge equipment. A fault lamp illuminates if a fault occurred and it will also be registered on the HMI alarms screen and sequence stopped until the fault is cleared.
- The operator then checks the roadway traffic visually and through CCTV and when convenient, presses the Start Wig Wags pushbutton. At the same time the wig wags and siren activate and warning red and amber lamps flash and the sounder sounds. LED illumination on the control desk show that all wig wags and sounders are healthy.

- When convenient, the operator then presses the 'close entry traffic barriers' illuminated pushbutton. Traffic on the bridge is then allowed to exit the bridge and when clear, the operator then presses the 'close exit traffic barriers' illuminated pushbutton. Traffic barriers are interlocked so that the entry barriers are not lowered at the same time as the exit barriers. The wig wags continue to operate but sounder is turned off.
- When all traffic is stopped the operator then presses the close pedestrian barriers/ gates pushbutton. The sounders stop sounding when the pedestrian barriers are confirmed in the lowered/closed position. The wig wag sounders are silenced but the red and amber lights keep flashing and keep flashing for the duration of the bridge operation. The bridge is now ready to lift.
- On the HMI screen the operator presses the Open Bridge Soft button and the following sequence is carried out automatically:
 - The nose locks retract and when confirmed retracted by limit switches, the HMI mimic changes to show the status.
 - The bridge leaf is accelerated to the open position. When the bridge leaf has reached the nearly open position, the bridge leaf is slowed to creep speed but continues to open and is stopped at the fully open positions. When the bridge leaf is confirmed in the open position, the bridge leaf stops rotating and the hydraulic operation machinery systems hold the bridge leaf in this position. (note: proximity switches and trunnion shaft mounted absolute encoders detect the bridge leaf position).
 - The operator then changes the appropriate navigation lights from red to green and vessels can navigate through selecting the direction of transit signalled by the lights.

3.1.8 Closing Sequence

The following closing sequence is based on bridge control from the operator control desk:

- When all vessels have passed, and the channel is clear the operator changes the Navigation lights from to Green to Red to stop vessels from navigating through.
- At the HMI the operator presses the 'close bridge' soft key and the following sequence is carried out automatically:
- The bridge leaf accelerates to normal speed before decelerating and coming slowly to the closed position. When the nearly closed position is detected, the motion is reduced to creep speed until the bridge leaf has reached its fully closed positions (note: proximity switches and machinery mounted absolute encoders detect bridge leaf positions).
- The nose locks extend and when confirmed fully extended the HMI mimic changes to show that:
 - The bridge is now ready to open to road traffic.
 - The operator presses the 'release all barriers' illuminated pushbutton. A warning message is issued to alert persons near the pedestrian barrier/gates that the barriers are about to move and after a 5 second delay (adjustable during commissioning time) all traffic and pedestrian barriers are raised allowing all traffic to resume. When all pedestrian barriers and traffic barriers are confirmed open, the Wig Wags are extinguished.
 - The operator then switches the HPUs off and switches the control power switch to off. The system is deactivated except for the HPU re-circulating pumps which continue to operate for a predetermined period to clean and cool the oil.

At each of the above stages, the HMI visual representation of the bascule span shall update to reflect each change of status.

At any time, the operator can stop the bridge motion by pressing the 'stop' button which does not stop the HPU but interrupts the bridge sequence. The operator can then continue with bridge operation to raise or lower the bridge.

If an 'emergency stop' pushbutton is pressed, all systems (including the HPU) are stopped and the navigation lights change from green to red. The 'stop' status is registered in the HMI. If the traffic and pedestrian barriers are lowered, they remain in that position. To continue with bridge operations the operator must release the emergency stop, reset the system and restart the HPU.

3.4 Describe communications systems involved

A comprehensive CCTV system shall be installed for surveillance of the bridge site for local operations.

The CCTV controller shall be ethernet based and designed for remote monitoring for multiple users. It shall include capabilities to transmit and receive audio and video signals via ethernet from the locations around the bridge structure to the controller.

Audio communications shall be provided through the CCTV controller via a local pc. The PC shall have all the features required for interface with the video monitors and audio communications including appropriate high resolution, multi output, audio and video cards, microphone and speakers. Any audio switchers or audio interface devices (amplifiers, multiplexers, etc.) Shall be provided to interface with the local PC, CCTV controller and field devices.

The public address system shall consist of stations that shall be used to produce one-way page announcements over system loudspeakers, support two-way party line communications and reproduce paging audio over attached speakers. The public address system shall communicate over Ethernet.

The CCTV, audio communications, and public address system shall be located in the control house. Monitors shall be mounted from the ceiling over the new control console.

VHF radio will be utilised to communicate with marine crafts.

3.5 Design requirements for emergency works testing and site operating Condition

The bridge control system shall consist of PLC, with digital and analogue I/O modules, HMI and UPS. A category 4 emergency stop circuit will be employed as part of the design. This will in turn remove power from the main hydraulic pump motors by de-energising the Hydraulic Power Unit (HPU) motor contactors and bringing the bridge to a controlled stop. Contactor monitoring will be employed to ensure contactor weld checking and failure.

The emergency stop shall be compliant with ISO 13 850/EN418, red mushroom head, press to stop, detented, twist-to-release type complete with round yellow legend plate. When the switch is released, the control system must be manually reset before any further operations can continue, providing any other emergency stops are not operating.

Emergency stop pushbutton stations shall be provided in the plant rooms and control room, at the following locations:

- Each Control Cabinet.
- On the HPU.
- On the operator control desk.
- Other locations as deemed necessary.

Operation of the emergency stop circuit results in stopping the bridge moving in a controlled manner. The reason for the emergency stop is displayed on the HMI.

Emergency stop stations are connected to safety-rated input cards that are controlled by safety PLC processors that will manage all safety protocols required by the control system. The safety inputs will have an emergency stop button as individual inputs.

This shall ensure that if, during routine inspections, there is hydraulic oil leakage the activation of an Emergency stop pushbutton shall inhibit bridge movement.

Releasing an emergency stop does not enable any equipment or plant operation until the operator resets the system and re-selects the operating mode.

Remote wireless emergency stop shall be compliant to the latest IEC 61508, secure data transmission standards.

3.6 Fail Safe Operation Safety Systems, Failure and Mode Effect (FME) Analysis

A Failure and Mode Effect Analysis (FMEA) shall be performed in the detailed design stage. The analysis shall consist of prioritizing system failures according to how serious their consequences are, how frequently they occur and how easily they can be detected.

The detailed design stage FMEA shall be documented used for continuous improvement.

The design of the bridge systems shall utilise the FMEA results in developing the detailed design. Major failures shall be identified and solutions to mitigate these failures shall be reflected in the final design.

An example of such approach would be the span hydraulic rams. The bridge deck is to be capable of being supported in the event of the failure of a single hydraulic ram to provide a supporting action. Monitoring devices will detect the failure of the failed ram and signal that further motion shall cease. The remaining hydraulic ram(s) is/are capable of supporting the bridge and then, after an assessment of the nature of the failure, lowering it to the closed position. An assessment of the failure will then determine if continued operation of the bridge is possible and under what conditions. Monitoring devices will also detect lack of synchronisation of the rams and will signal that further motion shall cease.

All nose locks will be monitored to ensure that they are fully inserted before the bridge can be permitted to carry live load.

3.6 Arrangements for Commissioning and Handover to Maintaining Authority Including Relevant Documentation and Operator's Manuals

3.7.1 Commissioning and Testing

- Fully test and adjust all parts of the system

- Demonstrate that the control system functions properly using all the different modes of operation, including all abnormal and fault conditions.
- Demonstrate the correct movement and speed of all parts of the system.
- Verify the correct position of all limit and proximity switches, adjusting as necessary.
- Verify and adjust if necessary, the setting of all pressure relief valves.
- Demonstrate that the entire system and all ancillary items operate fully in accordance with the requirements of the Specification.
- Provide a test schedule, which will test or verify all parts of the control logic and the emergency systems.
- Demonstrate functionality of the UPS System
- Carry out any further tests required by the Engineer.
- Operate the bridge under the instruction of the Engineer as required
- All results of all tests shall be documented

3.7.2 Acceptance Testing

- Acceptance tests will be carried out once the commissioning and testing is fully completed. The acceptance test will comprise of the demonstration by the Contractor of the entire system to “The Employers Engineer” and “The Employer” in one session.
- The reliability of the system will be tested by carrying out a minimum of ten full operations [AM1] of the bridge. Each full operation will employ each of the described bridge operations namely, fully automatic, fully manual and emergency operations. Demonstrate bridge operations under power outage conditions. An emergency stop will be demonstrated by tripping the safety circuit.
- The recovery procedures e.g. failed hydraulic ram shall be simulated.
- The results of all tests shall be documented.

3.7.3 Post Commissioning and Handover

The following shall be demonstrated and recorded:

Mechanical:

- Ensure that all greasing points have been charged sufficiently to view the grease issuing.
- Ensure that the hydraulic power units are filled with oil to the correct level.
- Check all fixings for tightness.

Electrical:

- Ensure that all systems, displays, lights and illuminated pushbuttons are operational.
- Ensure all system is safe and left in ‘automatic’ mode.

3.7.4 Documentation

The following list of quality related documents are to be provided as a minimum requirement, supplied as standalone documents with unique numbers with identifiable author, checker and approver:

- Material Test Certificates.
- NDT Certificates and Operator Approvals.
- Declaration of Conformity and/or Incorporation with relevant EU Safety Directives.

- Technical File fully indexed and catalogued, inclusive of essential health and safety risk assessment
- Heat Treatment Records.
- COSHH data sheets for all relevant substances.

The following list of design related data shall be provided:

- As-Built Drawings, including detailed drawings, assembly drawings and schematics.
- Design Check Certificate in accordance with the DMRB Technical Approvals Procedures.
- PLC software.

3.7.5 Operations and Maintenance (O&M) manuals

The O&M manual will include full details of the methods of inspection of the structure with relation to its effect on shipping and traffic management. The proposed documentation will comply with Irish Standards and comprise:

- Fully detailed instructions for the operation and maintenance of the whole scheme and plant, together with all necessary detailed drawings and spare parts schedules;
- Table of Contents.
- Operator's Instructions, which shall cover in full the step-by-step sequence of operation of the bridge and its auxiliaries and shall note all precautions required for correct operation. Complete instructions for the following shall be included:
 - Selection of the power supply.
 - Automatic, and Maintenance modes of operation of the span on commercial power source.
 - Emergency manual operation
- Detailed maintenance instructions for adjusting, lubricating, and operating all of the electrical equipment, including manufacturer's recommended preventative maintenance lubrication schedule.
- A set of descriptive leaflets, bulletins, and drawings covering all items of equipment and apparatus made a part of the completed bridge operation and control.
- The catalogue number of each piece, to be used in case it becomes necessary to order replacement parts from the manufacturer. This information shall be furnished for all electrical equipment such as motors, switches, circuit breakers, relays, cables, etc.
- A troubleshooting flow chart for troubleshooting the bridge electrical system shall be provided to facilitate the diagnosing and correcting of malfunctions.
- Instructions for diagnosing malfunctions of the programmable control system and for detecting failures in the external controls connected thereto.
- Names, addresses and telephone numbers of vendors and suppliers.
- Copies of all warranties on equipment supplied to the project.
- The complete spare parts list.
- All as-built schematics and wiring diagrams.
- The control console and control panel layouts and wiring diagrams for all equipment.
- A comprehensive schedule of electrical apparatus.
- All submitted final as-built shop drawings.
- All as-built cable layout and installation drawings.

- PLC schematic wiring, relay logic, PLC input/output hardwire diagram, PLC logic and PLC ladder diagrams.
- Descriptions of the plant.
- Safety precautions.
- Safe systems of work.
- Pre-start-up check lists.
- Isolation procedures.
- Routine check procedure.

NOTE: A risk assessment and method statement must be included in this section for any maintenance operations that contains any risk or is outside of being normal day to day maintenance.

The O&M manual shall be set out with the following sections:

- Contractual and Legal Guides.
- Safety precautions.
- Overall purpose.
- Description of the systems.
- Equipment schedule.
- Parts identification and recommended spares.
- Recommended spares policy.
- Commissioning data.
- Operation.
- Maintenance Instructions.
- Maintenance schedules.
- Modification information.
- Fault finding.
- Lubrication schedules.
- Disposal instructions.
- Index of drawings.
- Emergency operation.
- Manufacturers literature.

The sections should be split into volumes which reflect day to day usage, e.g.:

- Safety.
- Maintenance.
- Operation.
- Reference.

Three copies of the O&M documentation will be provided in both paper form and also electronically.

4 PLANT ROOM

The plant room will be situated in the bascule pier counterweight chamber. The layout will be developed as part of the design process and will consider aspects such as accessibility, the environment and the containment and protection of the equipment.

Pier plant room layouts will be developed in conjunction with the development of the control building and other associate plant rooms.

4.1 General layout

Each plant room houses, as a minimum, the following equipment:

- REC Meters/Cut-outs.
- Incoming mains supply isolator.
- Power Transfer Switch.
- Power Distribution Board (MCC).
- Main Control Panel.
- Hydraulic Power Unit.
- Telecom line connection boxes.
- Plant room Building Services panel to power:
 - Normal Lighting.
 - Building external lighting.
 - Emergency Lighting for both plant room and control room.
 - Heating.
 - Fire Alarm System.
 - Intruder Alarm System.
 - Power outlets.
 - At least 2 spare ways.

4.2 Drainage and associated pumping requirements

Drainage arrangements will ensure that spillages and any other contaminants from the machinery areas such as hydraulic oil cannot flow into the river. Drainage water will be connected to a small sump, which can easily be emptied. No contaminated discharges will be permitted.

4.3 Plant room and pier environment, heating, lighting, humidity, ventilation

The following services will be provided to control the environment of the plant rooms and control room:

- Normal Lighting.
- Battery backed emergency lighting.
- Heating (control room only).

It is not foreseen that humidity control will be required in the bascule pier that is to house the HPU.

4.4 Mechanical and Electrical equipment

The plant room will house the following equipment:

- Main electrical panels.
- Building services distribution panel.
- Lifting equipment for replacement of heavy plant.

- Ventilation.
- Work bench.
- A lifting runway beam will be provided to aid handling of heavy items of plant from their designated position to the outside entrance plant room access door.
- A workbench and a secure storage area for spares.
- Intruder alarm control panel.
- Bunded area for the storage of hydraulic oils.

The bascule pier will house:

- A hydraulic power unit.
- Hydraulic power unit areas will be bunded for the storage of hydraulic oils.

4.5 Security, intruder and fire alarm systems

- Fire Alarm System with connections for onward wiring/annunciations to remote station.
- Intruder Alarm System with connections for onward wiring/annunciations to remote station.
- CCTV System.

4.6 Proposed firefighting measures

The plant room and the control room will be equipped with all necessary fire extinguishers to suit the different types of fire identified during the fire hazard risk assessment.

5 DESCRIPTION OF INSPECTION AND MAINTENANCE ARRANGEMENTS

5.1 Proposals for inspection and maintenance of the moveable bridge structure or gantry given in the AIP for the Structure

Stairs will be provided to up to the control room and down into the bascule plant room. There will be no requirement for fall protection equipment for the hands-on accessibility to routinely maintainable MEICA equipment.

5.2 Proposals for inspection and maintenance of M&E installation

Access platforms with handrails will be provided in the plant room to all equipment requiring routine maintenance. This equipment includes, but is not limited to, trunnion bearings, hydraulic cylinders, HPUs, electrical drives, etc. No fall protection equipment will be required for the hands-on access of these areas.

5.3 Proposed documentation³

Recommended inspection and maintenance frequency of components will be provided in the O&M manuals.

5.4 Proposals for plant monitoring, data collection and management

Human Machine Interface:

- The HMI/PLC screens will be a panel PC component mounted in the operator control desk front.
- The HMI Flat Panel 19" LCD monitor and include but not limited to:
 - Bright TFT LCD screen display protected by a scratch-resistant, anti-reflective mineral glass
 - Connectivity to the PLC.
 - Connectivity to a laptop computer for downloading historical data.
 - All software and licenses.
- The HMI/SCADA default screen is to be programmed to display the current status of the Hydraulic power units and other site equipment. Each section of the control system is to be displayed on individual screens. The system also logs the most recent alarms which can be acknowledged using this page. By logging-in using a username and password code, operators can access the data such as:
 - Site wide general arrangement of equipment showing.
 - Show alarm history.
 - All data shown on the control panel graphic operator terminals.
 - All PLC inputs and outputs.
 - Override functions for safety lock out systems.
 - Operational run hours for all motors.
 - Read outs for all sensors and transducers.
 - Data logger to log fault code history, warnings, alarms, operating data etc with enough capacity to store data up to 30 days after which the older data is either overwritten or can be downloaded and stored. Alarms are not overwritten and remain on the PLC until downloaded.
- Other variables and screens can be set up as required.
- The data can be transferred from the HMI to a laptop via an inbuilt USB port.
- The system will include a facility for viewing the HMI screens and data at a remote station through the use of PC anywhere (or similar) software whereby a

remote operator(s) can dial in and log in the HMI/PLC to view system status and other screens. No parameter changes will be possible from the remote location.

APPENDIX 6 HYDRAULIC REPORT AND SECTION 50 APPLICATION

Hydraulic Report for OPW Section 50 Approval for the proposed Dodder Bridge at Ringsend Dublin.

On behalf of

**Roughan O Donovan
Consulting Engineers.**

September 2020

**Hydrological & Environmental
Engineering Consultants**

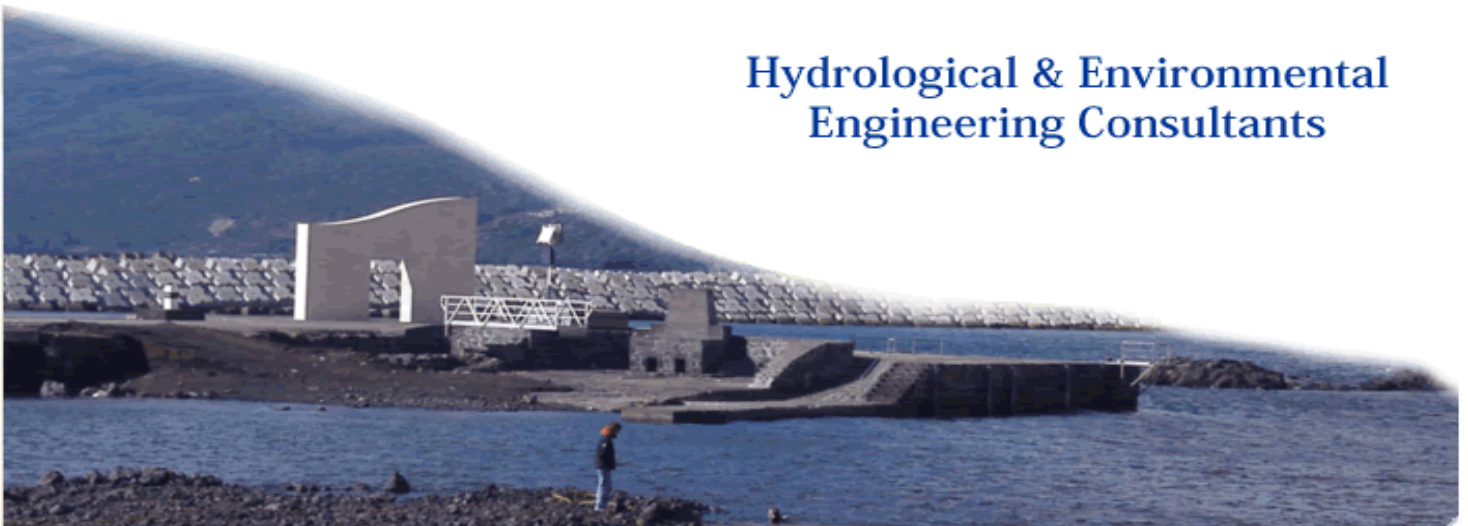

Hydraulic Report for OPW Section 50 Approval for the proposed Dodder Bridge at Ringsend Dublin.



Job No.:	220401
Report No.:	HEL220401v1.4
Prepared by:	Anthony Cawley BE, M.EngSc, CEng MIEI
Date:	14 th September 2020

© Hydro Environmental Ltd 2020

DISCLAIMER

This report has been prepared for Dublin City Council in support of a proposed Bridge over the Dodder near the Liffey Estuary confluence in Dublin. Hydro Environmental Ltd accept no responsibility or liability for any use that is made of this document other than by the Client for the purposes for which it was originally commissioned.

TABLE OF CONTENTS

1. INTRODUCTION.....	1
1.1 Background	1
1.2 Proposed Bridge.....	1
2. FLOOD HYDROLOGY OF THE DODDER CATCHMENT	3
2.1 General Description	3
2.2 Historical Flood Events.....	4
2.3 Flood Flow Estimation.....	5
2.3.1 General.....	5
2.3.2 Return Period Flood Flow Estimation – Gauged Frequency Analysis	5
2.3.3 FSU single Site Gauged Statistical Analysis	6
2.3.4 Ungauged FSU Physical Descriptor Method	8
2.3.5 CFRAM Flood Flow estimates (RPS 2008 and 2010)	10
2.3.6 CFRAM Combined Flood Analysis	12
2.4 Catchment Change Allowances.....	13
2.5 Climate change Allowance.....	13
2.5.1 Introduction	13
2.5.2 Climate Change Allowance for Fluvial Flood Flows.....	13
2.5.3 Sea level rise.....	14
2.5.4 Sea level rise for East Coast of Ireland.....	16
2.5.5 Recommended Climate change allowances	16
2.6 Recommended Design Flows	17
3. HYDRAULIC MODELLING OF BRIDGE STRUCTURE.....	18
3.1 Introduction	18
3.2 Design Flood Simulations.....	18
3.3 Flood Simulation Results.....	19
4. CONCLUSIONS.....	22

1. Introduction

1.1 Background

Hydro Environmental Ltd. was commissioned by ROD on behalf of Dublin City Council to carry out a hydrological Study of the proposed Dodder Bridge at Ringsend for the purpose of obtaining Section 50 Approval for the Bridge structure from the OPW.

This hydrological report has been prepared to support the Section 50 Application as is the requirement for consent from the OPW in respect to flooding and flood risk management. The Section 50 design requirements are for a design fluvial flood of 100year return period, combined coastal of 200year return period and inclusion of suitable climate change allowance and uncertainty. The bridge cross-section should not create significant afflux or impact negatively on flood risk of the surrounding area and should provide a minimum clearance between the design flood level and the bridge soffit of 1m for debris passage and clearance.

1.2 Proposed Bridge

The proposed Dodder bridge is a bascule bridge structure with a lifting section to enable vessel navigation to and from the Dodder Estuary and specifically the adjacent Grand Canal Docks. The bridge crossing location is immediately at the confluence along the southern Liffey channel wall and upstream of the East Point Bridge.

A cross-section of the proposed bridge is presented below in Figure 2 which has a large bascule Pier within the River channel which houses the lifting mechanism for the tilting bridge section over the 19m wide, deep navigation channel section on the western Bridge opening. The total length of the lifting section is c. 30m. The bridge has three spanning sections.

On the Eastern (right) bank of the Dodder channel at the Liffey (southern bank of the Liffey) at St. Patrick's Boat club, land reclamation of shallow mud flat area is proposed for the approach road and cycle paths to the proposed Dodder bridge and new boat club and a new boat club building, boat club yard area, slipway and moorings further into the Liffey channel for St. Patrick's Boat Club. The proposed reclamation boundary aligns itself with the southern Liffey Channel Wall upstream and with the East Point Bridge southern abutment downstream.

This reclamation removes c. 60m of channel mud flat width from the dodder / Liffey confluence on the eastern/southern channel bank, reducing the effective channel width to 92m that includes 11m Bascule pier width and 2.4m support pier width. Based on survey information the total open area of the bridge between soffit and bed is 626m² The bridge soffit level varies across the width from 4.15m OD at the eastern abutment to maximum height of 5.67 at 10m east

Section 50 Hydraulic Report for proposed Dodder Bridge

of the Bascule Pier and falling to 4.33 at the western abutment. The minimum deck level on the bridge is 5.5m OD. The length of the bridge from upstream to downstream is 20m and the length of the Bascule Pier is 11m. The total open area (from soffit to bed level) of the proposed bridge cross-section is 626m².



Figure 1 Proposed Bridge over Dodder at Liffey Confluence

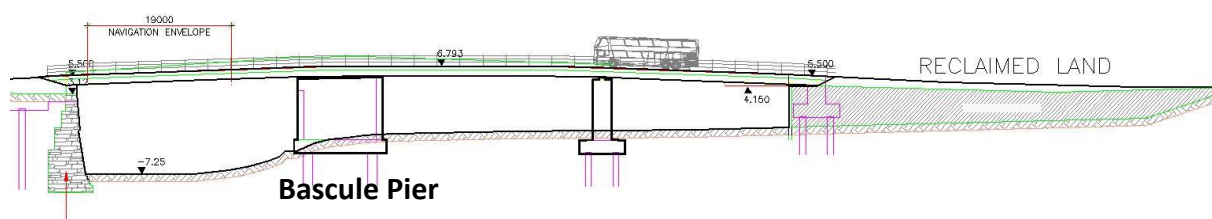

Figure 2 Cross Section of upstream face of Bridge

2. Flood Hydrology of the Dodder Catchment

2.1 General Description

The Dodder River rises in the Dublin Mountains and drains northwards through South Dublin to Ringsend where it outfalls with the River Liffey. The total catchment area to Ringsend is approximately 113km² and has a large downstream urbanised fraction of c. 35%, refer to Figure 3 below. This river is a very flashy river and has a history of flooding. Over the past century notable flooding events resulting in overtopping of river banks and inundation of the floodplain have occurred in 1905, 1912, 1915, 1931, 1946, 1958, 1965 and the historical worst event in 1986 (25th and 26th August – Hurricane Charlie), and also in November 2000. The Dodder's downstream reach is tidal from the Liffey Estuary.



Figure 3 River Dodder Catchment Map

2.2 Historical Flood Events

A list of the reported 15 largest flood events and estimated flood flows on the Dodder, gauged at Waldron’s Bridge Station (09010) over at least 120years is presented in Table 1 below. This information was derived from a combination of previous flood events on the Dodder (1880 – 1986) compiled by Jack Keyes (1987), paper by Cawley et al. 2005, and the EPA annual maximum (AM) flow series (MacCárthaigh EPA, 2005). The Hurricane Charlie Flood event in August 1986 represents the historical maximum flood in the Dodder in at least 120years if not significantly longer. This event hit the Dublin Mountains producing record rainfalls and caused extensive flooding in both the Dodder and its neighbouring catchment the Dargle that flows through Bray.

Table 1 List of highest Ranked floods on the Dodder at Orwell Weir

Date	Peak Flow (cumec)
25 August 1986	269
24 October 2011	213
25 August 1905	198
05 November 2000	156
03 September 1931	153
17 November 1965	139
19 December 1958	116
02 December 2003	112
11 June 1993	110
05 August 2008	108
05 November 1982	106
14 November 2014	87
09 April 1998	87
02 November 1968	85
11 June 1993	81

The number of properties flooded by the Dodder during Hurricane Charlie was estimated to be 340. The main areas of flooding were from Lower Dodder Road, Orwell Gardens, Dartry Cottages, Clonskeagh Road, Simmonscourt Terrace, Eglinton Road, Anglesea Road, Merrion Road, Wilfield Road, Gilford Road, Shelbourne Road, Ballsbridge Avenue and Beatty’s Avenue. Flooding was also observed on the Poddle (85 properties flooded), Camac (30 properties flooded) and Tolka (10 properties flooded) Rivers (Keyes, 1987).

The main hydrometric gauge for the Dodder River is at Waldron’s Bridge and is operated by the EPA (09010). This gauging station provides stage and flow estimates and from a flood estimation perspective this gauge has reasonably reliable record which included the Hurricane Charlie event of August 1986. In more recent years a lot of gaps and gauge downtime have appeared.

2.3 Flood Flow Estimation

2.3.1 General

As a requirement for Section 50 approval a range of flood estimation methods are applied to produce the recommended design flood event and peak flow magnitude. These vary from at site statistical analysis of gauged flows to ungauged flood estimation methods and synthetic rainfall-runoff modelling.

Fortunately the Dodder catchment is gauged at Waldron's Bridge towards the downstream end of the catchment and provides a reasonable long record of flood flows which allows statistical gauged methods to be considered for estimation return period design flows at the subject site in the form of a donor hydrological site.

2.3.2 Return Period Flood Flow Estimation – Gauged Frequency Analysis

Estimated flows using Censored EV1 distribution fitted to the estimated largest 15 floods in 120year period at Waldron Bridge was performed, refer to Figure 4 below and the return period quantile estimates are presented in Table 2.

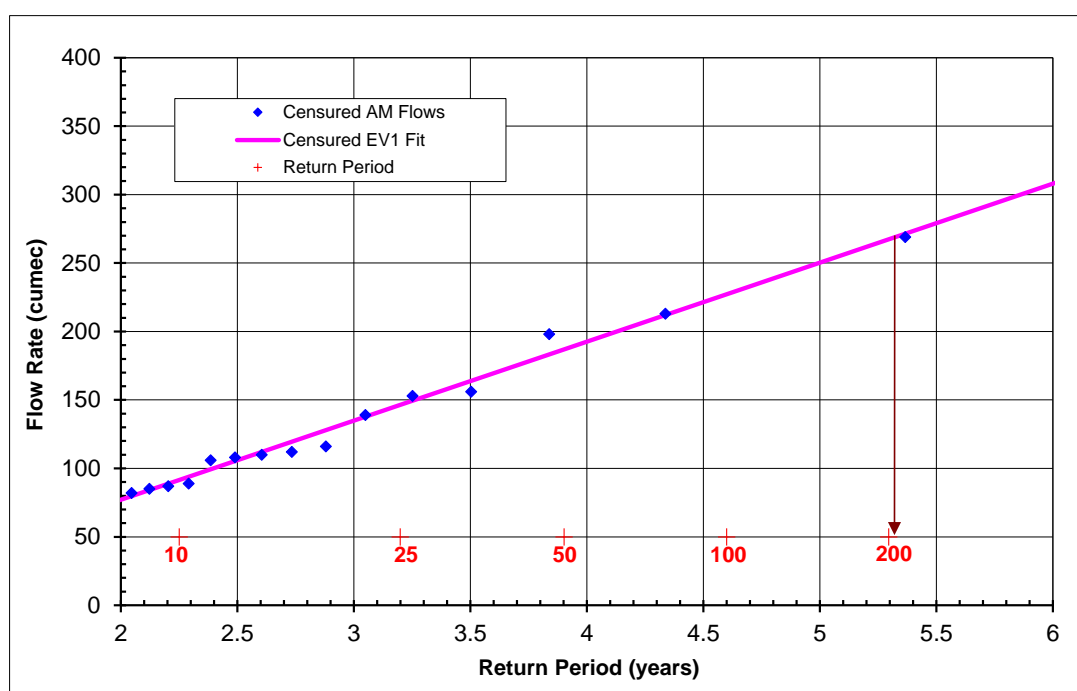

Figure 4 Censored EV1 fit to largest 14 floods in a 120year period

Table 2 Return Period Flood Flow estimates for the Dodder at Waldron Bridge (gauge site 09010)..

Return Period Years	Ev1 Y-variate	QT cumec
10	2.25	91.5
50	3.90	186.9
100	4.60	227.3
200	5.30	267.4
500	6.21	320.4
1000	6.91	360.5

This method is limited somewhat by uncertainty in the flow estimates for historical floods not gauged by the EPA (i.e. pre 1966).

2.3.3 FSU single Site Gauged Statistical Analysis

The Flood Studies Update (FSU) statistical method for gauged flood flow at Waldron Br. Gauge site are presented below in Figure s (Only 18years of AM values was available for this analysis (1986 to 2004) and therefore is not considered very reliable for estimating return periods of 40 year or greater. Pooled analysis does not assist in improving the reliability as there are very few, if any, gauged stations that are hydrologically similar to the Dodder to facilitate the development of a suitable pooling group. The choice of distribution has significant effect on the larger return period estimates with the GLO Distribution being convex and influenced by outlier magnitudes such as August 1986. An EV1 distribution was also considered which gave significantly lower flood magnitudes than the GLO at the larger return periods, refer to Figure 6 and Table 4.

Table 3 Return period Estimates from FSU Single Site Analysis fitting GLO distribution to 18years of data (1986 to 2004).

Return Period yrs	2	5	10	20	50	100	200	1000
XT= QT/Qmed	1	1.8	2.53	3.46	5.15	6.91	9.24	18.11
QT (cumec)	48	86.36	121.48	166.21	247.08	331.48	443.62	869.24

Table 4 Return period Estimates from FSU Single Site Analysis fitting EV1 to 18years of data (1986 to 2004).

Return Period yrs	2	5	10	20	50	100	200	1000
XT= QT/Qmed	1	1.79	2.32	2.83	3.48	3.97	4.46	5.59
QT (cumec)	48	86.15	111.4	135.63	166.98	190.48	213.9	268.13

Section 50 Hydraulic Report for proposed Dodder Bridge

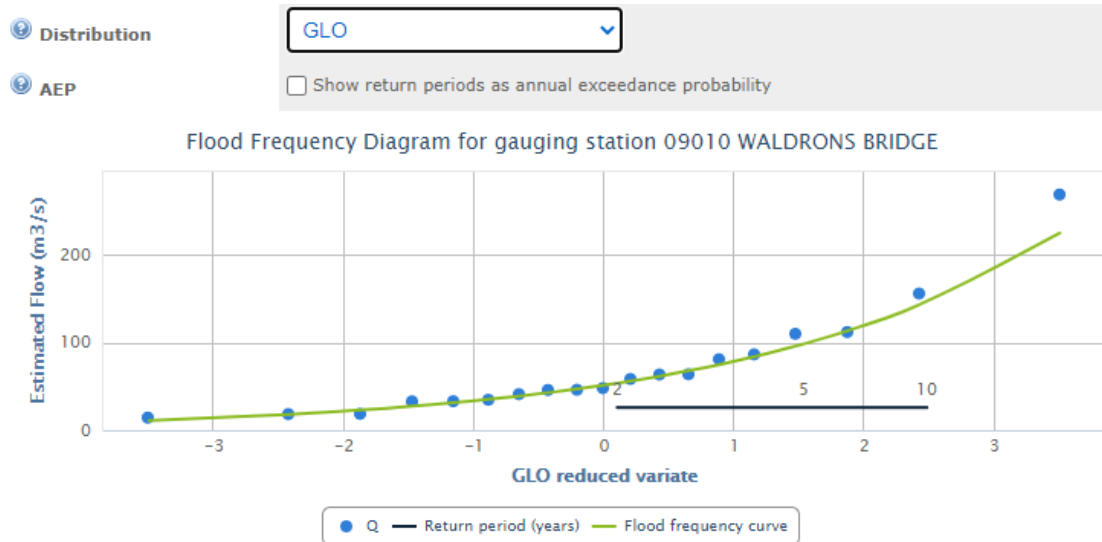

Figure 5 FSU Fitting General Logistic Distribution to Annual Maximum Series (1986 To 2004) at Gauge 09010 (Dodder at Waldron's Br.)

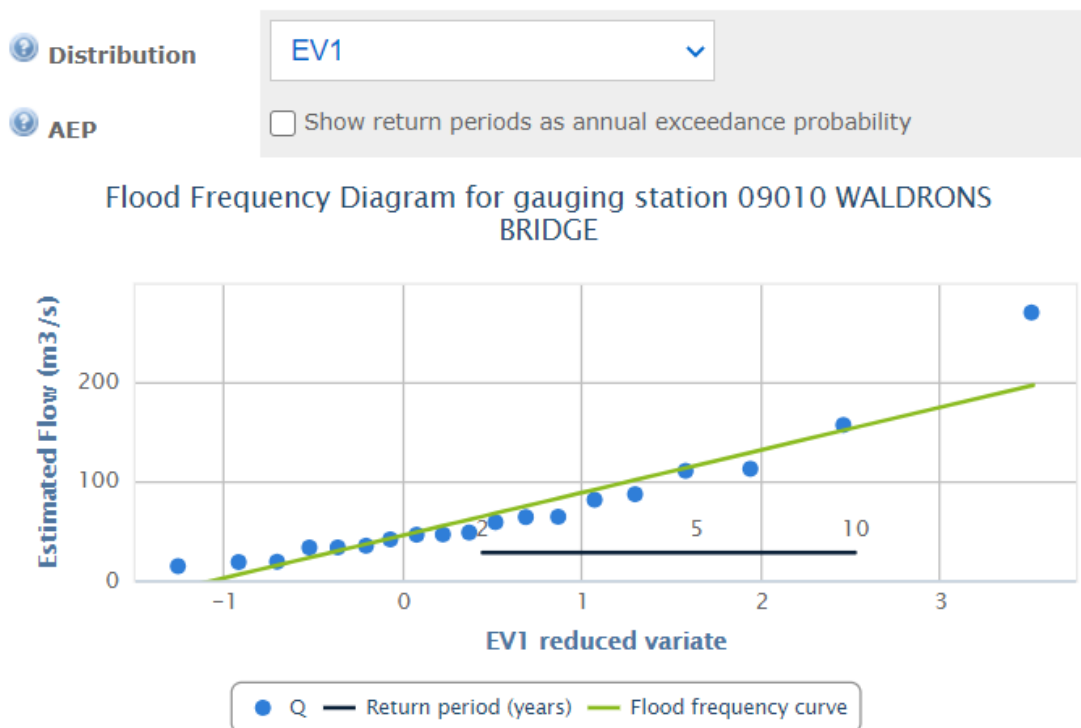

Figure 6 FSU Fitting EV1 (Gumbel) Distribution to Annual Maximum Series (1986 To 2004) at Gauge 09010 (Dodder at Waldron's Br.)

With only 18years of data the limit of reliability is a return period of 2T from single site analysis (i.e. 36years) and predictions of 100 year and 1000year are extremely unreliable.

2.3.4 Ungauged FSU Physical Descriptor Method

The FSU Physical Catchment descriptors for the Dodder to Waldron's Bridge gauge site and for the Ringsend reach at the Liffey confluence along with estimates of the 2yr (Qmedian) flood flow is presented below in the following Tables 5 and 6.

Table 5 OPW Flood Study Update Physical Catchment Descriptors and QMED estimate to Waldron's Bridge

PCD's		
AREA	94.3	km2
MSL	21.61	km
DrainD	1.47	km/km2
S1085	20.98	m/km
FARL	0.958	
SAAR	955	mm
URBAN	0.2404	
ARTDRAIN2	0	
BFISOILS	0.561	
PCD Qmedian	29.16	cumec
Pivotal Site Adjustment Factor (09010 - Waldron's Bridge)	1.650	
PCD Qmedian adjusted	48.111	cumec
Qmed recommended	48.11	cumec
Qmed rate	0.510	cumec/km2
Time to Peak (FSSR method)	3.2	hours
Design Rain Storm Duration	6.3	hours

Table 6 OPW Flood Study Update Physical Catchment Descriptors and QMED estimate to Liffey Confluence at Ringsend

PCD's		
AREA	112.8	km2
MSL	28.15	km
DrainD	1.339	km/km2
S1085	12.983	m/km
FARL	0.965	
SAAR	918	mm
URBAN	0.3471	
ARTDRAIN2	0	
BFISOILS	0.5465	
PCD Qmedian	34.16	cumec

Section 50 Hydraulic Report for proposed Dodder Bridge

Pivotal Site Adjustment Factor (09010 - Waldron's Bridge)	1.650	
PCD Qmedian adjusted	56.358	cumec
Qmed recommended	56.36	cumec
Qmed rate	0.500	cumec/km2
Time to Peak (FSSR method)	3.4	hours
Design Rain Storm Duration	6.5	hours

The FSU Growth Curve based on 500 station years of annual maxima from the most hydrologically similar catchments giving the following Growth factors and return period flood magnitudes, refer to Table 7.

Table 7 FSU Flood Flow Estimates for the Dodder

Return Period years	Growth Factor XT -= QT/Qmed	Flood Flow QT Waldron's Br. cumec	Fluvial Flood QT Ringsend cumec
2	1	48.1	56.4
5	1.25	60.1	70.5
10	1.41	67.8	79.5
20	1.58	76.0	89.0
50	1.82	87.6	102.6
100	2.02	97.2	113.8
200	2.23	107.3	125.7
1000	2.81	135.2	158.4

These flood flow magnitudes are considerably lower than the at-site flood frequency estimates presented earlier in this study analysis, the RPS CFRAM flood estimates and the historical recorded flow estimates. This is due to a considerably milder flood growth curve with a 100year growth factor from the Pooling group of 2.02 and 1000year of 2.81. The CFRAM 100year estimate of 201cumec suggests a 100year growth factor of 4.18 (which is very large for Irish Catchments).

A study carried out by Bruen and Gebre (2005) on small east of Ireland catchments produced a 100year and 1000year growth factors of 2.84 and 3.84 respectively. The return period flow estimates using the Dublin growth curve for small catchments is presented below in Table 8.

Table 8 Flood Flow Estimates for the Dodder using Dublin Region Growth curve Bruen and Gebre (2005)

Return Period years	Growth Factor XT -= QT/Qmed	Flood Flow QT Waldron's Br. cumec	Fluvial Flood QT Ringsend cumec
2	1.00	47.9	56.2
5	1.49	71.6	83.9
10	1.82	87.3	102.3
20	2.13	102.4	120.0
50	2.53	121.9	142.8
100	2.84	136.5	159.9
200	3.14	151.0	176.9
1000	3.84	184.7	216.4

These ungauged FSU estimates are significantly lower than gauged estimates and previous historical Flood events and therefore will not be relied on in selecting the Design Flood Magnitude.

The above FSU Catchment Descriptor method indicates that the annual flood flow QMED at Ringsend is 14.6% greater than the QMED flow estimate at Waldron's Bridge. The difference in catchment area between the two sites is 19.6%. This percentage increase in flood peak magnitude between the two sites will be used to extrapolate the return period flood magnitudes from the gauged site at Waldron's Br. to the subject site at Ringsend in the downstream Dodder Reach.

2.3.5 CFRAM Flood Flow estimates (RPS 2008 and 2010)

The RPS River Dodder Flood Relief Scheme Study hydrology Analysis report (October 2008) gives the following return period flood estimates for the Dodder at Waldron's Bridge gauge based on the fitting of an exponential distribution to Peaks over threshold series of EPA gauged flood flows from 1966 to 2006 (Threshold set at 60cumec). It should be noted that RPS used their revised rating based on modelling which generally reduced the estimate peak flows by between 5 and 7% (e.g. Hurricane Charlie EPA estimate of 269 cumec was reduced to 251 cumec (7% reduction) with the revised RPS rating equation)). Summary of the return period flood flows from the 2008 Hydrology Report are presented below in Table 9.

Table 9 RPS Dodder Flood Relief Scheme (2008/2010) return period flood flow estimates for Waldron’s Bridge Gauge 09010

Return Period years	Flood Flow QT (cumec)
5	108.1
10	130.6
25	159.0
50	180.1
100	201.0
200	221.8
1000	270.0

Note the Flood maps associated with the Dodder Flood Relief scheme (published 26 Nov 2010) study and presented in the Hydraulics report give the following return period flood flows under the present day scenario, refer to Table 10 below. These estimates which were used in the hydraulic modelling for the flood inundation mapping and are significantly different from the tabulated values for the gauged flows at Waldron’s Bridge presented in the 2008 Hydrological Analysis and in the combined analysis in the 2010 hydraulics report.

Table 10 Published Return Period flood flow magnitudes from RPS Flood Inundation mapping for the Dodder from the CFRAM Study (refer to Dodder CFRAM Figures DR/EXT/UA/CURS/101 Nov 2010)

	170m u/s of Waldron Bridge gauge 12,896	U/s of Ballsbridge Ch 17,655
Return Period years	Flood Flow QT (cumec)	Flood Flow QT (cumec)
10	134.0	139.4
100	226.8	207.1
1000	486.1	529.2

Table 11 Published Return Period flood flow magnitudes from RPS Flood Hydraulics report for Joint Probability Flows used in the hydraulic flood modelling.

	Waldron Bridge reach downstream of Dundrum Stream	Downstream Reach (Ringsend Reach
Return Period years	Flood Flow QT (cumec)	Flood Flow QT (cumec)
5	126.5	143.8
10	151.8	173.8
50	227.6	266.0
100	270.6	319.3
200	321.9	383.7
1000	482.9	591.2

These higher return period flow estimates were generated using catchment Rainfall-Runoff modelling of the different sub-catchments and included joint probability analysis for the tributary streams and the different urban sub-catchments and their contributions. Essentially this rainfall – runoff modelling is ungauged modelling using a synthetic hydrograph and runoff coefficients and therefore not very reliable. The flow estimates are significantly higher than the gauged estimates for Waldron’s Bridge at 26% and 79% for the 100 and 1000year events respectively.

In the CFRAM report there is no explanation for the large differences between the rainfall-runoff estimates used in the flood inundation modelling and the Hydrology Report gauged estimates from the frequency analysis of gauged flows, particularly the large difference in the 1000year estimates. There is also no explanation as to why the gauged estimates were ignored in favour of potentially less reliable Rainfall-Runoff model results. In any case the use of these higher estimates represent a more conservative approach.

2.3.6 CFRAM Combined Flood Analysis

The combined analysis between coastal and fluvial flooding for the Dodder presented in the CFRAM Hydraulic Analysis Report July 2010 give the following return period combined estimates.

Table 12 Combined Analysis Fluvial Flood Flows (gauged analysis) and Tidal Storm surge Levels

Combined Return Period years	Fluvial Flood Flow Waldron’s Br. cumec	Fluvial return Period years	Tidal Flood Level in Liffey Estuary mOD	Tidal return period years
2	74.3	2	2.42	1.5
5	108.2	5	2.44	2
10	130.6	10	2.44	2
25	159.0	20	2.48	2.5
50	180.1	50	2.51	3
100	201.0	100	2.56	5
200	221.8	200	2.60	7
1000	270.0	1000	2.73	19
Combined Return Period years	Tidal Flood Level in Liffey Estuary mOD	Tidal return period years	Fluvial Flood Flow Waldron’s Br. cumec	Fluvial return Period years
2	2.46	2	68.9	1.75
5	2.58	5	83.3	2.5
10	2.67	10	91.5	3.1
20	2.76	20	105.9	4.6
50	2.88	50	103.9	4.4
100	2.97	100	104.0	4.4
200	3.07	200	103.9	4.4
1000	3.28	1000	95.6	3.5

2.4 Catchment Change Allowances

The future urban development within the Dodder catchment is likely to significantly increase over the next 100year horizon given the proximity of the catchment to Dublin and the relatively small size of catchment. Therefore, the continued implementation of SUD's policy for the urbanised catchment is extremely important as is the maintenance and of existing SUD's facilities. It is not clear as to the likely footprint increase of urbanisation within the catchment as planning policy is likely to favour higher rise development to limit the urbanized spread and sprawl out into the scenic Dublin Mountains. It is assumed for the purpose of this study that future Urban development will implement SUD's in order to limit storm runoff to present day greenfield runoff rates. Therefore, no additional allowance is made for urbanisation in the future.

2.5 Climate change Allowance

2.5.1 Introduction

According to the United Nations Intergovernmental Panel on Climate Change (2007) there is unequivocal evidence of climate change

"most of the observed increase in global average temperatures since the mid-20th century is very likely due to the observed increase in anthropogenic greenhouse gas concentrations." (Climate Change 2007, IPCC, Fourth Assessment Report AR4)

There is a high degree of uncertainty in relation to the potential effects of climate change, and therefore a precautionary approach is required. Examples of precautionary approach include:

- Recognising that significant changes in the flood extent may result from an increase in rainfall or tide level and accordingly adopting a cautious approach to zoning lands in these potential transitional areas.
- Ensuring that the finish levels of structures are sufficient to cope with the effects of climate change over the lifetime of the development.
- Ensuring that structures to protect against flooding (e.g. defence walls) are capable of adaptation to the effects of climate change when there is more certainty about the effects (e.g. foundations of flood defence designed to allow future raising of flood wall to combat climate change).

2.5.2 Climate Change Allowance for Fluvial Flood Flows

Climate change scenarios suggest for UK and Ireland fluvial floods in the 2080's increasing by up to 10 to 20% (low and medium low scenarios) and by up to 20 to 30% (medium high and high scenarios). Present recommendations are to include in the design flow a 20% increase in flood peaks over 50 years return period as a result of climate change. This scenario based on the Irish growth curve will result in a present day 100 year flood becoming a 25-year flood in

approximately 50 years time. The extent and expected levels of flooding are derived based on these flows.

In the UK, research is ongoing to assess regional variations in flood allowances and the rate of future change. Current research thus far does not provide any evidence for the rate of future change let alone consider regional variations in such a rate. The UK Flood and Coastal Defence Appraisal Guidance (DEFRA, 2006) gives the climate change ranges as per Table 1 below and as a pragmatic approach it is suggested that 10% should be applied up to 2025, rising to 20% beyond 2025.

In Ireland general practice is to use a medium range climate change allowance for flood flows of 20% over the next 100 years. This rate has been adopted by the OPW for all of its Catchment Flood Risk Assessment and Management Studies (Lee, Dodder, Tolka CFRAMs, Shannon, West, etc.).

Table 13 UK flood and coastal defence appraisal guidance (DEFRA, 2006)

UK Flood and coastal appraisal guidance (DEFRA, 2006)				
Parameter	1990 – 2025	2025 - 2055	2055 - 2085	2085 - 2115
Peak rainfall intensity (preferably for small catchments)	+5%	+10%	+20%	+30%
Peak river flow (preferably for larger catchments)	+10%	+20%		

2.5.3 Sea level rise

Scientists predict that global sea level rise will have two main causes. Firstly, as the oceans heat up the water expands. At present this thermal expansion accounts for about half of the observed increase in sea level. The other cause is melting land ice from glaciers and ice caps. The rate of melt and the volumes of water locked within these sources are uncertain and this is a cause for concern.

In recent years, ice shelves have broken off huge ice sheets in Antarctica and Greenland. The ways in which they are melting is only now beginning to be understood fully enough to allow estimates of how fast this melt is occurring and how much this will affect sea levels. If they melt as fast as is now thought to be possible, sea levels could rise dramatically over the next century, flooding many of the world’s major cities and much of the world’s most productive

farmland. Consequently, guidance on sea level rise allowances for flood risk management is continually changing as more scientific research is published with allowances likely to increase as opposed to decrease in future years.

The biggest threat to coastal flood risk areas is from sea level rise. Global mean sea levels are predicted to increase from a combination of thermal expansion of the water column and melt from the glaciers and reduction of liquid water storage on land. The Intergovernmental Panel on Climate Change Third Assessment Report (*IPPC TAR*) that preceded the published *IPCC Fourth Assessment Report (2007)* has been used as the basis of future sea level projections for Ireland. A best estimate increase of 480 mm to year 2100 has been suggested by Sweeney et al (2003) and used in the *Greater Dublin Strategic Drainage Study (GSDSDS 2005)*. This value was not directly challenged in the 2007 *IPCC* report, with a range of 0.2 - 0.51 m given for the prudent Medium-High A2 emission scenario.

The IPCC fifth Assessment Report (2014) has investigated the current and future trends in global mean sea level rise (GMSLR) and have concluded with a high level of confidence under various emission scenarios considered (four modelled RCPS (Representative Concentration Pathways) that thermal expansion of the sea due to warming will increase Global mean sea level by between 0.15 to 0.3m by 2100. This report predicts at medium confidence the contribution of glacier mass loss to GMSLR for the four RCP scenarios. The global glacier volume is projected to decrease by 15 to 55% for RCP2.6, and by 35 to 85% for RCP8.5 and in between these rates for the other two RCP scenarios. RCP2.6 is representative for scenarios leading to very low greenhouse gas concentration level, it is a so called “peak” scenario with radiative forcing reaching a peak level of 3.1 W/m² mid-century and returning back to 2.6W/m² by 2100. RCP8.5 is characterised by increasing greenhouse gas emissions overtime leading to high greenhouse gas concentrations by 2100.

Projections of GMSLR by 2100 under the high RCP8.5 scenario are 0.53 to 0.98m with rises of 8 – 16mm/annum during 2081 to 2100 and under the low RCP2.6 scenario are a rise is 0.28 to 0.61mm.

Observations of GMSLR show that from 1901 to 1990 1.5mm per annum mean rise and from 1993 to 2010 the mean rise was 3.2mm per annum.

The IPCC concluded that it is very likely that sea level will rise in more than about 95% of the ocean area. About 70% of the coastlines worldwide are projected to experience sea level change within 20% of the global mean sea level change. GMSLR during 1901–2010 can be accounted for by ocean thermal expansion, ice loss by glaciers and ice sheets, and change in liquid water storage on land. It is very likely that the 21st-century mean rate of GMSLR under all RCPs will exceed that of 1971–2010, due to the same processes. It

is virtually certain that global mean sea level rise will continue for many centuries beyond 2100, with the amount of rise dependent on future emissions.

2.5.4 Sea level rise for East Coast of Ireland

An annual rate of sea level rise for Ireland of 3.5mm per year has been observed for the period 1993 – 2003 which is higher than the longer term observed rate of 1.8mm per year for the period 1963 – 2003. This trend is likely to be more modest in the Irish Sea with a ‘net trend’ (allowing for isostatic adjustment of the earth’s crust) of 2.3 – 2.7mm per year.

Assessment of Potential Future Scenarios for Flood Risk Management’ (OPW, 2009), it is recommended that a mid-range future scenario of a 500mm rise in sea levels is considered and a 1000mm increase in sea levels is considered for the high-end future scenario. These allowances would seem appropriate and consistent with the higher end estimates from the regional climate change predictions when both sea level rise and an increase in storm surge are considered.

An allowance of 550mm mean sea level rise to the year 2120, which accounts or a 500mm increase in mean sea level and 50mm increase for isostatic land movement adjustment will be included for in this study to simulate a potential id-range future climate change scenario for the development.

2.5.5 Recommended Climate change allowances

The recommended climate change allowance for the proposed project, summarised below in Table 14 are the Mid-Range Future Scenario representing 550mm increase in sea level and 20% increase in Flood Flow magnitudes.

Table 14 Climate Change Allowances for Future Scenarios 100 year

Criteria	Mid-Range Future Scenario MRFS	High-End Future Scenario HEFS
Mean Sea Level Rise	+500mm	+1000mm
Land Movement	-0.5mm/year	-0.5mm/year
Extreme Rainfall Depths	+20%	+30%
Flood Flows	+20%	+30%

Mid-range scenario adopted in the CFRAM studies throughout Ireland and will also be considered for this site-specific flood risk assessment and section 50 application.

2.6 Recommended Design Flows

A variety of flood estimation methods both gauged and ungauged have been applied to the Dodder River to estimate return period flood events. All of the methods have been used to provide an estimate at the Waldron Bridge Gauge Site refer to Table 15 below for 100year fluvial flow estimates from these various methods. Based on FSU catchment descriptors the Qmed estimate is c. 15% larger at the downstream subject site at Ringsend. This 15% increase will be used for all return periods.

Table 15 Summary of 100year flood flow peak magnitude in the Dodder to Waldron’s Weir (catchment area 94km²)

Method	HEL censored gauged analysis	FSU PCD with FSU pooling group	FSU PCD with Dublin Growth Curve	CFRAM gauged Analysis	CFRAM Rainfall-Runoff method	Recorded Historical maximum
Q100 cumec	227.3	97.2	136.5	201.0	270.6	269

Note: Not included in this table is the FSU gauged site analysis as on 18years AM series was used which makes the method very unreliable at the larger return periods of say 100year.

For the purpose of Section 50 approval for the proposed bridge the estimation method to be used is the CFRAM rainfall- runoff modelling giving a 100year flow magnitude of 270.6cumec at Waldron Bridge and increased to 311.2cumec at the subject site (i.e. 15% increase as a result of larger catchment).

The section 50 approval requires consideration in tidal areas of the combined 200year return period event with a maximum fluvial return period of 100years and maximum tidal return period of 200years. From the CFRAM study by RPS (Hydraulic Report 2010) the combined 200year event is estimated to be a 200year Tidal event of 3.07mOD with a 4.5year return period fluvial flood in the Dodder of 136.5cumec and a 100year fluvial flood event of 311.2cumec combining with a 9 year tidal flood of 2.65m OD.

Under present day conditions the combined 200year event to be considered is

- A 100fluvial flood of 311.2cumec and a downstream tide level of 2.65m
- A 200year downstream tide level of 3.07 and a fluvial flow of 136.5cumec

The climate change allowance to be considered in the Section 50 application is the medium-range future change scenario which has a 20% increase in flood flow magnitude and a sea level rise including isostatic tilt of 550mm.

Under these future conditions the combined 200year event to be considered is

- A 100fluvial flood of 373.4cumec and a downstream tide level of 3.2m
- A 200year downstream tide level of 3.62 and a fluvial flow of 163.8cumec

3. Hydraulic Modelling of Bridge Structure

3.1 Introduction

In order to assess the impact of the proposed bridge structure on flooding and flood levels a 1-D HEC RAS hydraulic model of the Dodder and Liffey was developed using the CFRAM Liffey survey, the Dodder channel Survey from the Flood relief study, a recent bathymetric survey carried out by Aquafact of the Dodder-Liffey Confluence area and the Liffey Estuary Bathymetric surveys that were obtained from Dublin Port.

It is important to point out that the proposed Bridge crossing in the deep navigable section of the Dodder Estuary has a generous open area for flow through the bridge providing a total open area from bed to bridge soffit level of 626m².

The simulations assume that all flood flow is within the river/estuary channel in the downstream reach of the Dodder such that it must pass through the proposed bridge structure as it joins the Liffey Estuary.

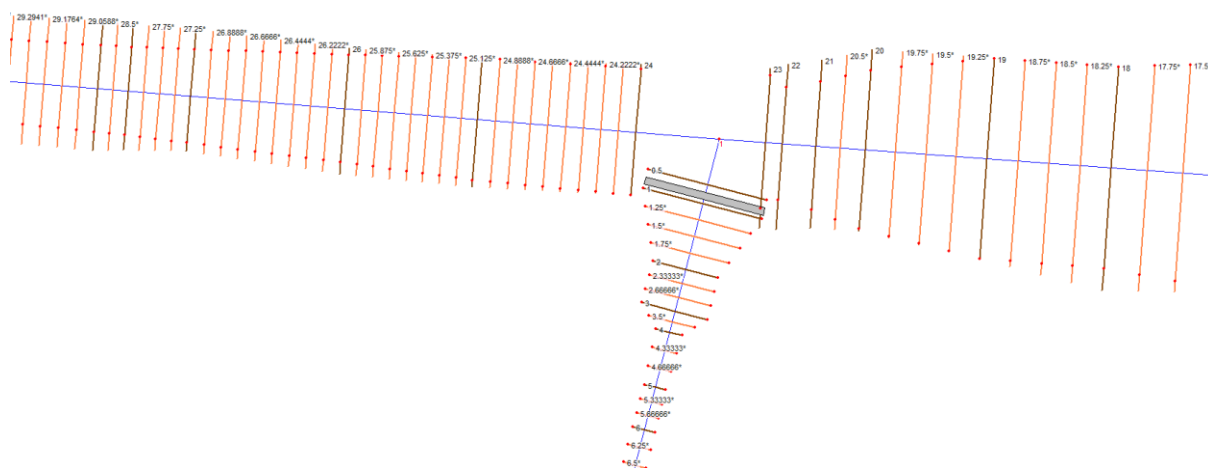

Figure 7 Schematic of 1-D model topology in the vicinity of the Dodder Liffey confluence

3.2 Design Flood Simulations

The critical design flood simulations for investigating the bridge flow capacity for section 50 approval is at high flood levels associated with the high tide in the downstream Liffey estuary. Other tidal stages due to lower water levels through the bridge will generate higher flow velocities through the bridge structure and potentially higher upstream afflux but such conditions do not impact the associated flood risk.

The critical design flood events are the present day and future climate change combined 200year flood event as follows:

- Simulation 1 Present day 100year Dodder Fluvial Flood Flow of 311.2cumec with tidal flood level of 2.65m OD (9year tidal event)
- Simulation 2 Present day 4.5year Dodder Fluvial Flood Flow of 136.5cumec with 200year tidal flood level of 3.07m OD
- Simulation 3 Future 100year Dodder Fluvial Flood Flow of 373.4cumec with tidal flood level of 3.2m OD (9year tidal event)
- Simulation 4 Future 4.5year Dodder Fluvial Flood Flow of 163.8cumec with 200year tidal flood level of 3.62m OD

3.3 Flood Simulation Results

To assess the potential afflux generated by the proposed bridge structure described earlier in Section 1 steady state hydraulic analysis with the upstream peak design flow and the downstream peak tidal level were specified for each of the four design Flood Simulations.

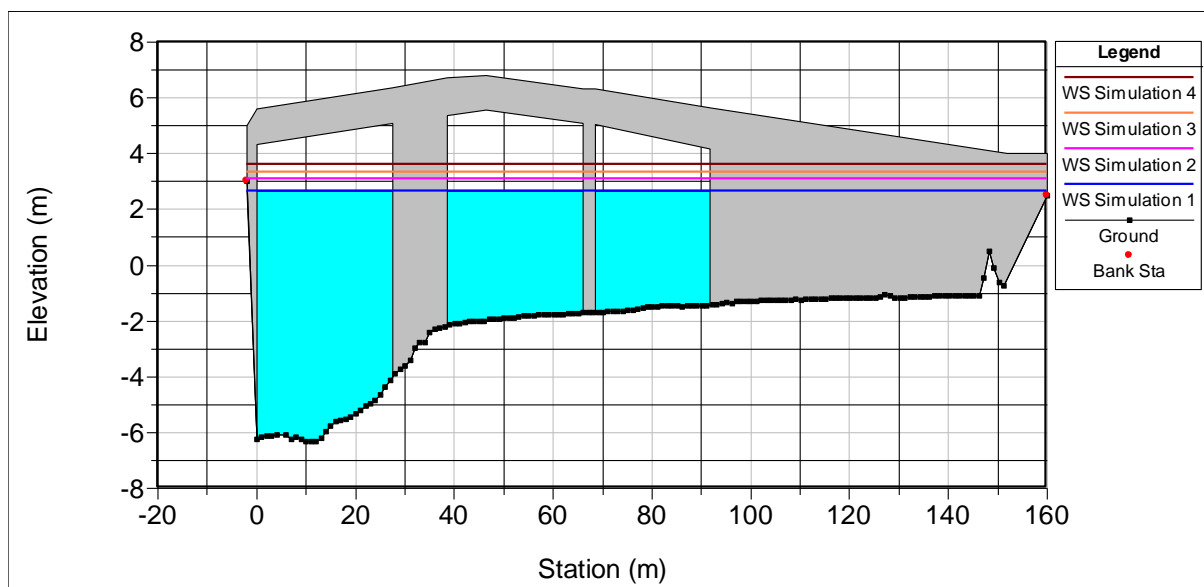

Figure 8 Proposed Bridge Cross-section showing the predicted flood levels for the four design Simulations

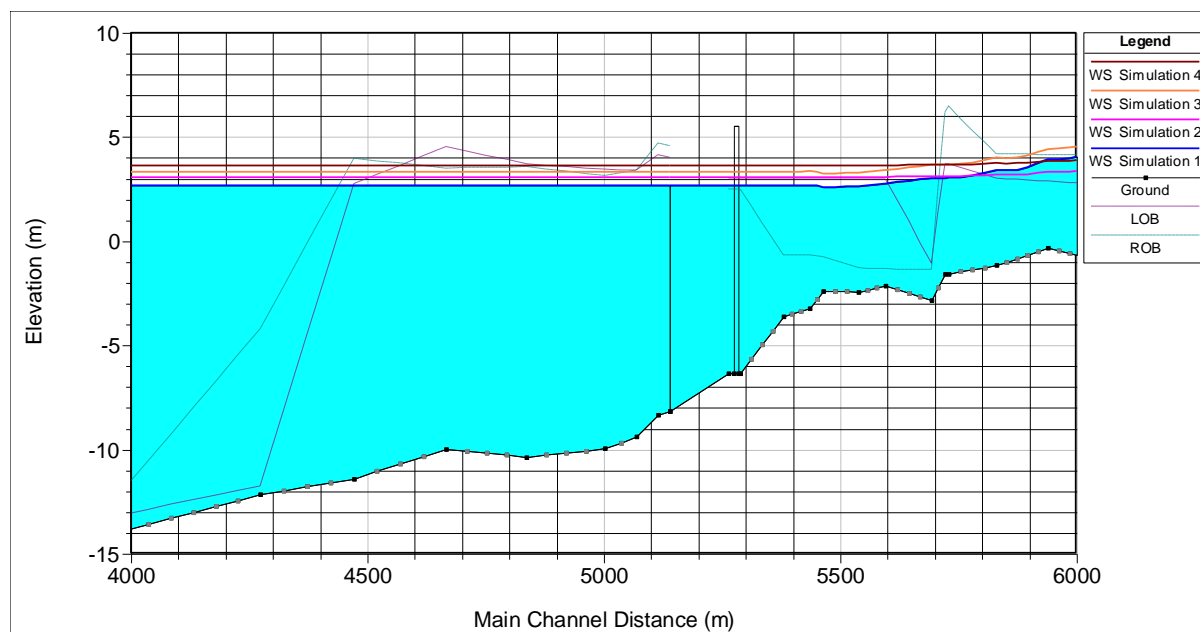

Figure 9 Computed Flood Level Profile in Lower Dodder and Lower Liffey estuary

Table 16 Computed Flood Levels and resultant upstream afflux at Bridge for combined 200year Flood Events both present day and future Climate change

200yr Design Events	Dodder Flow Rate cumec	Tide level m OD	Predicted Flood Level at Bridge Site m OD	Predicted afflux m
Simulation 1	311.2	2.650	2.690	0.042
Simulation 2	136.5	3.070	3.078	0.008
Simulation 3	373.4	3.200	3.247	0.047
Simulation 4	163.8	3.620	3.629	0.009

In respect to maximum flood levels the critical event at the proposed bridge is the 200year storm surge event producing a maximum flood level at the bridge site of 3.078m OD under the present day conditions and 3.629 under the medium emission future scenario. At critical peak flood levels the predicted upstream afflux from the proposed bridge structure is small at less than 1cm for the 200year Storm surge tidal event combining with 4.5year fluvial event. The high Fluvial Flood flow events generate the higher afflux with the 100year fluvial flow generating 4.2 and 4.7cm at high tide.

Combination of Dodder Peak Flow with different tidal stages will generate high afflux due to reduced flow area associated with lower water level but such stages are not critical in respect to flooding. To demonstrate this the 100year present and future fluvial flood is combined with low water as presented in cross-section and long-sectional model output in Figures 10 and 11.

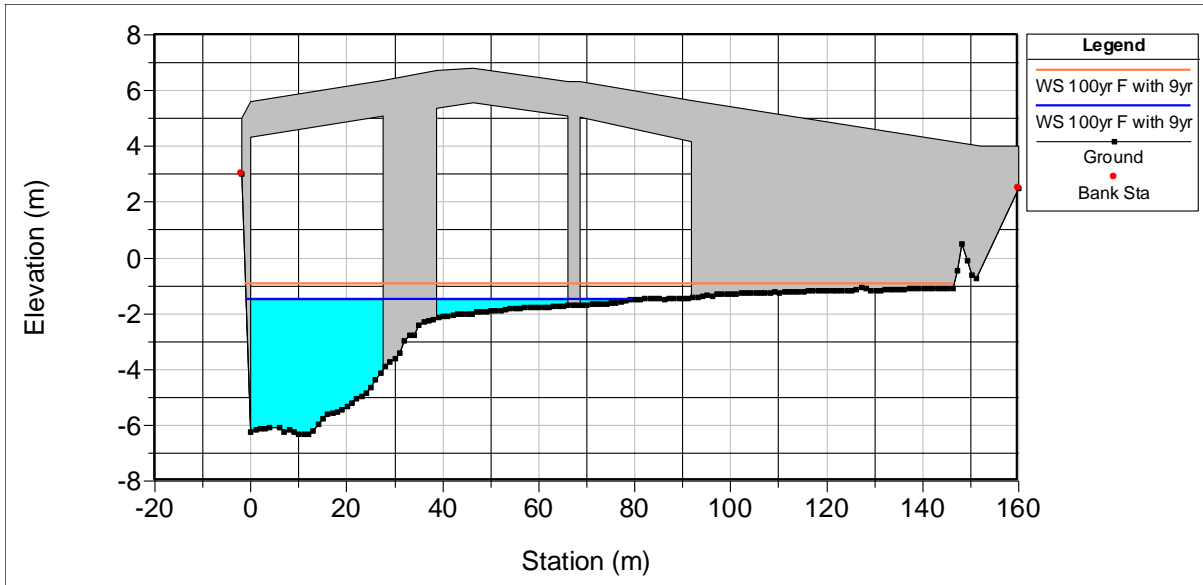

Figure 10 Bridge Cross-section showing the predicted flood levels for the 100year fluvial events (Simulations 1 and 3) combining at Low Water

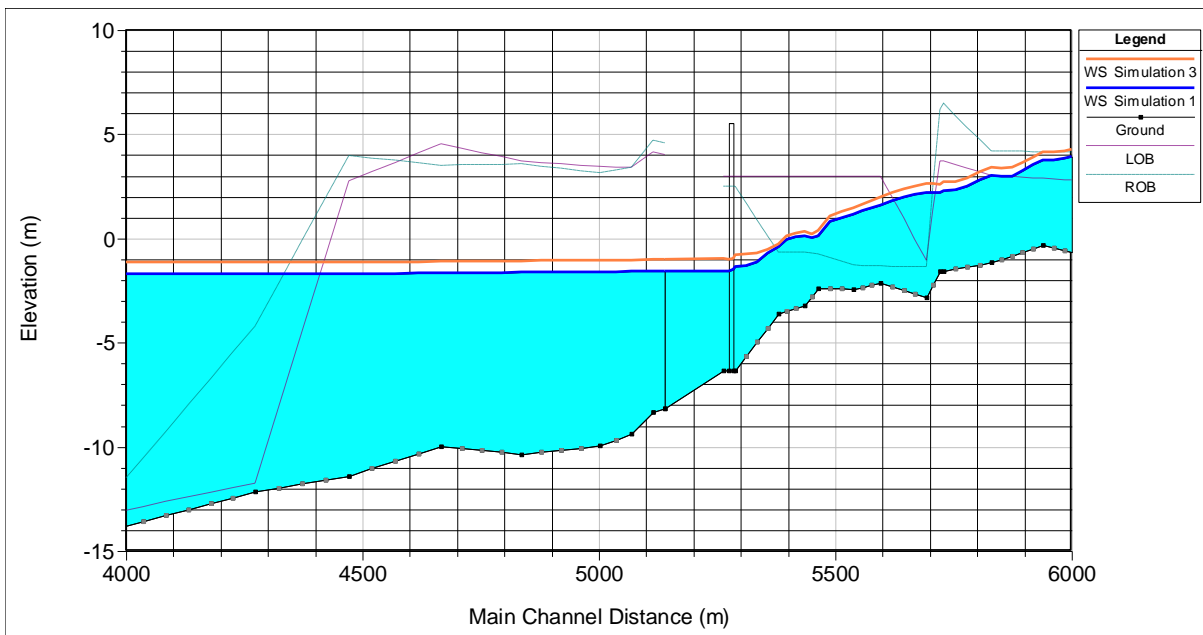

Figure 10 Bridge Cross-section showing the predicted flood levels for the 100year fluvial events (Simulations 1 and 3) combining at Low Water

The maximum afflux is generated under the 100year fluvial flood conditions in the Dodder and at Low water (i.e. when the tide is fully out). The predicted Low water under such conditions without the Bridge is -2.013 and -1.398 for the present and future cases and with the bridge the predicted low water flood levels are -1.349 and -0.798m OD.

4. Conclusions

The proposed Dodder Bridge at Ringsend is amply sized for the combined 200year tidal Flood Event and will not result in increased flooding or flood risk in the Dodder or Liffey.

The predicted medium range future emission design flood event produces a peak flood level at the proposed bridge site of 3.628mOD. The Soffit levels of the bridge varies form a minimum level of 4.15 to a maximum level of 5.45m OD providing clearances above the future design flood level of 0.52 (at the eastern abutment) to 1.82m (mid span).

The proposed Bridge structure meets the hydraulic requirements set out in the OPW section 50 process.

Appendix 1 – Section 50 application



**Construction, Replacement or Alteration of Bridges and Culverts
Application for Consent under Section 50 of the Arterial Drainage Act, 1945 & EU (Assessment
and Management of Flood Risks) Regulations SI 122 of 2010**

Project Name	Dodder Bridge	Structure Ref No.	
Applicant (Correspondence will issue to agent)			
Company or Organisation Name:		Dublin City Council	
Postal Address:		Dublin City Council, Block 2 Floor 5, Civic Offices, Wood Quay, Dublin 8, Ireland	
Contact Person:		Karen Kennedy	
Phone:	353 1 22260	Mobile:	353 86 8151562
E-mail:		karen.kennedy@dublincity.ie	

Agent (Correspondence will issue to agent)			
Company or Organisation Name:		Roughan O'Donovan Ltd.	
Postal Address:		Arena House, Arena Road, Sandyford, Dublin 18, D18 V8P6.	
Contact Person:		Joe Kelly	
Phone:	01 294 0800	Fax:	
E-mail:		joe.kelly@rod.ie	

Location and Parameters of crossing			
Watercourse:	Dodder Estuary	Catchment:	Dodder
Address (Townland – County):		Ringsend	
Grid Reference	X: 717864	Y: 734244	
Hydrometric Station(s) utilized (including reference number):		09010 Dublin Port tide gauge	
Area of Contributing Catchment:	112Km²	Road Reference:	A New bridge
Design Flood Flow:	373.4m³/s	Annual Exceedance Probability (AEP):	1 %

Statement of Authenticity	
I hereby certify that the information contained in this application form, along with all appended supporting information, has been checked by me and that all statements are true and accurate.	
Name:	Joe Kelly
Company/Organisation:	Roughan and O'Donovan Ltd.
Signature:	
Date:	23/09/2020

Application Check List	<input type="checkbox"/>
COMPLETED APPLICATION FORM	<input checked="" type="checkbox"/>
SUPPORTING HYDROLOGICAL AND HYDRAULIC INFORMATION	<input checked="" type="checkbox"/>
PHOTOGRAPHS COVERING SITE OF ALL PROPOSED WORKS	<input checked="" type="checkbox"/>
SCALED PLAN OF BRIDGE/CULVERT/APPROACH EARTHWORKS	<input checked="" type="checkbox"/>
SCALED CROSS SECTION OF BRIDGE/CULVERT/APPROACH EARTHWORKS	<input checked="" type="checkbox"/>
SCALED LONG SECTION OF CHANNEL THROUGH BRIDGE/CULVERT	<input checked="" type="checkbox"/>
DETAILS OF RELEVANT EXISTING STRUCTURES	<input checked="" type="checkbox"/>
COMPLETED STATEMENT OF AUTHENTICITY	<input checked="" type="checkbox"/>
PLAN OF CATCHMENT AREA	<input checked="" type="checkbox"/>
COPY OF NOTICE OF GRANT OF PLANNING PERMISSION WITH CONDITIONS *1	<input type="checkbox"/>

For OPW use only	Date of Receipt							
OPW Drainage Maintenance Region	East	<input type="checkbox"/>	South East	<input type="checkbox"/>	South West	<input type="checkbox"/>	West	<input type="checkbox"/>

If the application form is not completed correctly, and in its entirety, the application may be deemed invalid and returned for correction.

Correspondence Number	OPW Register No:	
	Consent Issued	<input type="checkbox"/>

ADDITIONAL INFORMATION

Hydrological Analysis			
Methodology Applied			Factors Applied
Method Used	Tick box if used or state other	Flow *2 (m ³ /sec)	Type of Factor / Value Used
6 – Variable Catchment characteristics			Climate Change 1.20
3 – Variable Catchment Characteristics			Irish Growth Curve
IH 124	<input type="checkbox"/>		Factor for Standard Error
Gauged Flow	<input checked="" type="checkbox"/>		Drained Channel
Unit Hydrograph	<input checked="" type="checkbox"/>		Other 6.48
FSU methods	<input checked="" type="checkbox"/>		
Other	<input type="checkbox"/>		
FSR <input type="checkbox"/>	FSU <input type="checkbox"/>	Other <input type="checkbox"/>	Tidal <input checked="" type="checkbox"/>
Comments A variety of method were examined from gauge flood frequency, fsu and rainfall runoff modelling. Gauged Qmed = 48cumec			Comments The design tidal event produced the maximum flood level with a rise of 0.55 being included for sea level rise (medium range). 200year tide with 4.5year fluvial Dodder

Hydraulic/Structure Details	
Description of Structure *3	three span structure with a Bascule Pier and Lifting section 20m in width upstream to downstream
Effective Conveyance Area *4	626m²
Upstream Invert Level mOD	Downstream Invert Level mOD
Upstream Soffit Level 5.45 mOD	Downstream Soffit Level 5.45 mOD
Upstream Design Flood Level 3.628 mOD	Downstream Design Flood Level 3.62 mOD

NOTES :

- In line with OPW policy, section 50 approvals should be sought for bridges and culverts that are necessary for access or deemed acceptable by the planning authority. A copy of the notice of grant of planning permission with all conditions should be enclosed with all applications, that are not exempt development under the Planning and Development Act, 2000, as evidence that these factors have been considered.
- Flow is the estimated flow from the catchment, without any factors applied.
- The following details are to be included: the channel bed level, invert and soffit levels of the structure along with the width, length and total conveyance area. Any environmental considerations such as bed depression, baffles, mammal walkways etc. should be described.
- Effective conveyance area is from channel bed level to design flood level.
- All levels must be given to Ordnance Datum, Malin Head.

If the application form is not completed correctly, and in its entirety, the application may be deemed invalid and returned for correction.



**Mr. Joe Kelly
Roughan O'Donovan
Arena House
Arena Road
Sandyford
Dublin 18
D18 V8P6**

Joe.kelly@rod.ie

Our Ref: 416 - 2020

**Re: Section 50 Application – Proposed bridge on the river Dodder at Ringsend
Dublin.**

Dear Mr. Kelly,

I refer to the above Section 50 application received by this office.

The documentation submitted has been examined and I recommend that the consent of the Commissioners of Public Works under Section 50 of The Arterial Drainage Act, 1945 be given for the proposed culvert as follows:

A 20m wide, three span structure (33m, 25.15m and 26.4m) with a bascule pier and lifting section and a soffit level of 5.45mOD as per that detailed on attached Dwg no; 210201 Rev P01

It should be noted that consent is given only for the purpose of Section 50 and does not absolve the recipient of responsibility for any adverse effects caused by this installation to any third party.

The Commissioners of Public Works are not responsible and accept no liability for any loss or damage whatsoever caused because of this development.

Yours sincerely,

A handwritten signature in blue ink that reads "Karen Donovan".

**Karen Donovan
Engineering Services Administration Unit
2nd November 2020**

APPENDIX 7 COST ESTIMATE BASE INFORMATION

APPENDIX 7.1 PRICING DOCUMENT CIVIL WORKS



DODDER PUBLIC TRANSPORTATION OPENING BRIDGE



PRELIMINARY DESIGN REPORT COST ESTIMATE |
SEPTEMBER 2020

DPTB-ROD-C1-SWE-RPT-CV-00026-01 Appendix 7



Dodder Public Transportation Opening Bridge										
Bill Part 1: Dodder Public Transportation Bridge										
Bill Part/ Constr Heading/ Series	Item No.	Item Description	Unit	Quantity	Rate	Amount €	Totals €	Cost Estimate		
								Rate	Amount €	Totals €
		Construction Heading 1: Preliminaries								
		Series 100: Preliminaries								
		Special Preliminaries - General								
1/1/100		Environmental geotextile screen/ boom at intermediate pier supports	item	1	_____ / ____	_____ / ____		€12,600.00	€12,600.00	
1/1/100		Temporary bridge for intermediate pier piling/ cofferdam construction including river access during construction	item	1	_____ / ____	_____ / ____		€486,000.00	€486,000.00	
1/1/100		Channel fendering	item	1	_____ / ____	_____ / ____		€63,000.00	€63,000.00	
1/1/100		Pier protection	item	1	_____ / ____	_____ / ____		€25,200.00	€25,200.00	
1/1/100		Navigation markers to piers and channel	item	1	_____ / ____	_____ / ____		€18,900.00	€18,900.00	
		TOTAL CARRIED FORWARD TO Construction Heading 1 SUMMARY					_____ / ____			€605,700.00

Dodder Public Transportation Opening Bridge								Cost Estimate		
Bill Part 1: Dodder Public Transportation Bridge								Rate	Amount €	Totals €
Bill Part/ Constr Heading/ Series	Item No.	Item Description	Unit	Quantity	Rate	Amount €	Totals €			
1/1/100		Construction Heading 1: Preliminaries - Summary Series 100: Preliminaries TOTAL CARRIED FORWARD TO Bill Part 1 SUMMARY					_____ / _____ _____ / _____			€605,700.00 €605,700.00

Dodder Public Transportation Opening Bridge							Cost Estimate			
Bill Part 1: Dodder Public Transportation Bridge							Rate	Amount €	Totals €	
Bill Part/ Constr Heading/ Series	Item No.	Item Description	Unit	Quantity	Rate	Amount €	Totals €	Rate	Amount €	Totals €
		Construction Heading 2: Substructure End Supports - West Abutment SJRQ								
1/2/100		Series 100: Preliminaries								
1/2/100		Special Preliminaries - General								
1/2/100		Protection to the existing quay wall protected structures, in particular during abutment construction which is to be located behind the existing quay walls	item	1	_____ / _____	_____ / _____		€18,900.00	€18,900.00	
		TOTAL CARRIED FORWARD TO Construction Heading 2 SUMMARY					_____ / _____			€18,900.00
1/2/200		Series 200: Site Clearance								
1/2/200		Take Up or Down and Set Aside for Reuse or Remove to Store or Tip off Site								
1/2/200		Take up or down and set aside for reuse - Paved areas; surface paving	m ²	305	_____ / _____	_____ / _____		€12.60	€3,843.00	
		TOTAL CARRIED FORWARD TO Construction Heading 2 SUMMARY					_____ / _____			€3,843.00
1/2/500		Series 500: Drainage and Service Ducts								
1/2/500		Drainage and Service Ducts in Structures (Including Reinforced Earth Structures and Anchored Earth Structures)								
1/2/500		Drainage - Substructure - end supports	m ²	75	_____ / _____	_____ / _____		€12.60	€945.00	
		TOTAL CARRIED FORWARD TO Construction Heading 2 SUMMARY					_____ / _____			€945.00
1/2/600		Series 600: Earthworks								
1/2/600		Excavation								
1/2/600		Excavation - Unacceptable Material Class U1 - Structural foundations - 0 metres to 3 metres in depth	m ³	108	_____ / _____	_____ / _____		€7.50	€810.00	
1/2/600		Excavation - Unacceptable Material Class U2 - Structural foundations - 0 metres to 3 metres in depth	m ³	215	_____ / _____	_____ / _____		€8.75	€1,881.25	
1/2/600		Disposal of Material								
1/2/600		Disposal - Unacceptable material Class U1	m ³	108	_____ / _____	_____ / _____		€14.50	€1,566.00	
1/2/600		Disposal - Unacceptable material Class U2	m ³	215	_____ / _____	_____ / _____		€190.00	€40,850.00	
1/2/600		Imported Fill								
1/2/600		Imported acceptable material fill - Fill above structural concrete foundations	m ³	425	_____ / _____	_____ / _____		€23.50	€9,987.50	
1/2/600		Compaction of Fill								
1/2/600		Compaction - Acceptable material - Fill above structural concrete foundations	m ³	425	_____ / _____	_____ / _____		€4.50	€1,912.50	
1/2/600		Completion of Formation and Sub-formation								
1/2/600		Completion of formation - On Blinding material	m ²	220	_____ / _____	_____ / _____		€84.00	€18,480.00	
1/2/600		Ground Water Lowering								
1/2/600		Ground water lowering	item	1	_____ / _____	_____ / _____		€13,882.26	€13,882.26	
1/2/600		Breaking up and Perforation of Redundant Pavements								
1/2/600		Breaking up of redundant pavements - Pavement at SJRQ Development - Depth exceeding 100mm but not exceeding 200mm	m ²	220	_____ / _____	_____ / _____		€19.02	€4,184.75	
		TOTAL CARRIED FORWARD TO Construction Heading 2 SUMMARY					_____ / _____			€93,554.27
1/2/1600		Series 1600: Piling and Embedded Retaining Walls								
1/2/1600		Piling Plant								
1/2/1600		Establishment of piling plant - Bored cast-in-place piles - 800mm Diameter - Preliminary piling as a separate operation in advance of the main piling	no	1	_____ / _____	_____ / _____		€16,497.75	€16,497.75	
1/2/1600		Establishment of piling plant - Bored cast-in-place piles - 800mm diameter - Main piling	no	1	_____ / _____	_____ / _____		€16,497.75	€16,497.75	
1/2/1600		Moving piling plant - Bored cast-in-place piles - 800mm Diameter - Preliminary piling as a separate operation in advance of the main piling	no	1	_____ / _____	_____ / _____		€202.38	€202.38	
1/2/1600		Moving piling plant - Bored cast-in-place piles - 800mm diameter - Main piling	no	14	_____ / _____	_____ / _____		€202.38	€2,833.35	
1/2/1600		Cast-in-place Piles								
1/2/1600		Pile shafts - Vertical - Reinforced concrete piles - 800mm diameter - Pile shafts exceeding 20 metres in length but not exceeding 25 metres - Preliminary piling as a separate operation in advance of the main piling	m	25	_____ / _____	_____ / _____		€378.49	€9,462.18	
1/2/1600		Pile shafts - Vertical - Reinforced concrete piles - 800mm diameter - Pile shafts exceeding 20 metres in length but not exceeding 25 metres - Main piling	m	350	_____ / _____	_____ / _____		€378.49	€132,470.58	
1/2/1600		Reinforcement for Cast-in-place Piles								
1/2/1600		Bar reinforcement - Nominal size 20 millimetres and over - Grade B500B - Bars not exceeding 12 metres in length	t	7.4	_____ / _____	_____ / _____		€1,225.00	€9,065.00	
1/2/1600		Bar reinforcement - Nominal size 16 millimetres and under - Grade B500B - Bars not exceeding 12 metres in length	t	22.2	_____ / _____	_____ / _____		€1,225.00	€27,195.00	
1/2/1600		Proof Loading of Piles								
1/2/1600		Establishment of proof loading equipment - 800mm diameter bored cast-in-place piles - Preliminary piles - Maintained load - Vertical	item	1	_____ / _____	_____ / _____		€4,500.00	€4,500.00	
1/2/1600		Establishment of Integrity testing equipment - 800mm diameter bored cast-in-place piles - Preliminary piles - Sonic Echo testing - Vertical	item	1	_____ / _____	_____ / _____		€600.00	€600.00	
1/2/1600		Establishment of Integrity testing equipment - 800mm diameter bored cast-in-place piles - Main piles - Sonic Echo testing - Vertical	item	1	_____ / _____	_____ / _____		€600.00	€600.00	
1/2/1600		Proof loading piles - 800mm diameter bored cast-in-place piles - Preliminary piles - Maintained load - Vertical	no	1	_____ / _____	_____ / _____		€14,812.50	€14,812.50	
1/2/1600		Integrity testing of piles - Sonic Echo Testing - 800mm diameter bored cast-in-place piles - Preliminary piles	no	1	_____ / _____	_____ / _____		€22.50	€22.50	
1/2/1600		Integrity testing of piles - Sonic Echo Testing - 800mm diameter bored cast-in-place piles - Main piles	no	14	_____ / _____	_____ / _____		€22.50	€315.00	
		TOTAL CARRIED FORWARD TO Construction Heading 2 SUMMARY					_____ / _____			€235,073.98
1/2/1700		Series 1700: Structural Concrete								
1/2/1700		In Situ Concrete								
1/2/1700		In situ concrete - C40/50 Mix Foundation Pilecap, Abutment and Wingwalls	m ³	285	_____ / _____	_____ / _____		€135.00	€38,475.00	
1/2/1700		In situ concrete - C40/50 Mix Retaining Walls and Base	m ³	45	_____ / _____	_____ / _____		€137.50	€6,187.50	
1/2/1700		In situ concrete - Mix ST1 - Blinding Concrete 75mm or less in thickness	m ³	20	_____ / _____	_____ / _____		€82.50	€1,650.00	
1/2/1700		Surface Finish of Concrete - Formwork								
1/2/1700		Formwork - Vertical more than 300mm wide - F1 finish	m ²	180	_____ / _____	_____ / _____		€47.50	€8,550.00	
1/2/1700		Formwork - Vertical more than 300mm wide - F4 finish	m ²	115	_____ / _____	_____ / _____		€100.00	€11,500.00	

Dodder Public Transportation Opening Bridge								Cost Estimate		
Bill Part 1: Dodder Public Transportation Bridge								Rate	Amount €	Totals €
Bill Part/ Constr Heading/ Series	Item No.	Item Description	Unit	Quantity	Rate	Amount €	Totals €			
1/2/1700		Steel Reinforcement for Structures								
1/2/1700		Bar reinforcement - Nominal size 16 millimetres and under - Grade B500B - Bars not exceeding 12 metres in length	t	7.1	_____ / ____	_____ / ____		€1,225.00	€8,697.50	
1/2/1700		Bar reinforcement - Nominal size 20 millimetres and over - Grade B500B - Bars not exceeding 12 metres in length	t	44.8	_____ / ____	_____ / ____		€1,225.00	€54,880.00	
		TOTAL CARRIED FORWARD TO Construction Heading 2 SUMMARY					_____ / ____			€129,940.00
1/2/1800		Series 1800: Structural Steelwork								
1/2/1800		Miscellaneous Metalwork								
1/2/1800		Miscellaneous metalwork - Access manhole to abutment gallery	no	1	_____ / ____	_____ / ____		€1,890.00	€1,890.00	
1/2/1800		Miscellaneous metalwork - Access manhole ladder	no	3	_____ / ____	_____ / ____		€630.00	€1,890.00	
		TOTAL CARRIED FORWARD TO Construction Heading 2 SUMMARY					_____ / ____			€3,780.00
1/2/2000		Series 2000: Waterproofing for Structures								
1/2/2000		Waterproofing								
1/2/2000		Waterproofing - Epoxy resin MCDUR 1680 or similar approved - More than 300mm wide horizontal or at any inclination up to and including 30° to the horizontal	m ²	220	_____ / ____	_____ / ____		€13.50	€2,970.00	
1/2/2000		Waterproofing - Epoxy resin MCDUR 1680 or similar approved - More than 300mm wide at any inclination more than 30° up to and including 90° to the horizontal	m ²	95	_____ / ____	_____ / ____		€13.50	€1,282.50	
1/2/2000		Waterproofing - Spray applied membrane - More than 300mm wide horizontal or at any inclination up to and including 30° to the horizontal	m ²	220	_____ / ____	_____ / ____		€32.00	€7,040.00	
1/2/2000		Waterproofing - Spray applied membrane - More than 300mm wide at any inclination more than 30° up to and including 90° to the horizontal	m ²	215	_____ / ____	_____ / ____		€33.00	€7,095.00	
		TOTAL CARRIED FORWARD TO Construction Heading 2 SUMMARY					_____ / ____			€18,387.50
1/2/2300		Series 2300: Bridge Expansion Joints and Sealing of Gaps								
1/2/2300		Sealing of Gaps								
1/2/2300		Joint filler - Compressible filler between abutment base and retaining wall bases and walls as described on the drawings	m ²	5	_____ / ____	_____ / ____		€31.25	€156.25	
		TOTAL CARRIED FORWARD TO Construction Heading 2 SUMMARY					_____ / ____			€156.25

Dodder Public Transportation Opening Bridge										
Bill Part 1: Dodder Public Transportation Bridge										
Bill Part/ Constr Heading/ Series	Item No.	Item Description	Unit	Quantity	Rate	Amount €	Totals €	Cost Estimate		
								Rate	Amount €	Totals €
		Construction Heading 2: Substructure End Supports - West Abutment SJRQ - Summary								
1/2/100		Series 100: Preliminaries					_____ / _____			€18,900.00
1/2/200		Series 200: Site Clearance					_____ / _____			€3,843.00
1/2/500		Series 500: Drainage and Service Ducts					_____ / _____			€945.00
1/2/600		Series 600: Earthworks					_____ / _____			€93,554.27
1/2/1600		Series 1600: Piling and Embedded Retaining Walls					_____ / _____			€235,073.98
1/2/1700		Series 1700: Structural Concrete					_____ / _____			€129,940.00
1/2/1800		Series 1800: Structural Steelwork					_____ / _____			€3,780.00
1/2/2000		Series 2000: Waterproofing for Structures					_____ / _____			€18,387.50
1/2/2300		Series 2300: Bridge Expansion Joints and Sealing of Gaps					_____ / _____			€156.25
		TOTAL CARRIED FORWARD TO Bill Part 1 SUMMARY					_____ / _____			€504,579.99

Dodder Public Transportation Opening Bridge								Cost Estimate		
Bill Part 1: Dodder Public Transportation Bridge								Rate	Amount €	Totals €
Bill Part/ Constr Heading/ Series	Item No.	Item Description	Unit	Quantity	Rate	Amount €	Totals €	Rate	Amount €	Totals €
		Construction Heading 3: Substructure End Supports - Ringsend Side								
1/3/500		Series 500: Drainage and Service Ducts								
1/3/500		Drainage and Service Ducts in Structures (Including Reinforced Earth Structures and Anchored Earth Structures)								
1/3/500		Drainage - Substructure - end supports	m ²	60	_____ / _____	_____ / _____		€12.60	€756.00	
		TOTAL CARRIED FORWARD TO Construction Heading 3 SUMMARY					_____ / _____			€756.00
1/3/600		Series 600: Earthworks								
1/3/600		Completion of Formation and Sub-formation								
1/3/600		Completion of formation - On Blinding material	m ²	90	_____ / _____	_____ / _____		€84.00	€7,560.00	
1/3/600		Ground Water Lowering								
1/3/600		Ground water lowering	item	1	_____ / _____	_____ / _____		€13,882.26	€13,882.26	
		TOTAL CARRIED FORWARD TO Construction Heading 3 SUMMARY					_____ / _____			€21,442.26
1/3/1600		Series 1600: Piling and Embedded Retaining Walls								
1/3/1600		Piling Plant								
1/3/1600		Establishment of piling plant - Bored cast-in-place piles - 800mm Diameter - Preliminary piling as a separate operation in advance of the main piling	no	1	_____ / _____	_____ / _____		€16,497.75	€16,497.75	
1/3/1600		Establishment of piling plant - Bored cast-in-place piles - 800mm diameter - Main piling	no	1	_____ / _____	_____ / _____		€16,497.75	€16,497.75	
1/3/1600		Moving piling plant - Bored cast-in-place piles - 800mm Diameter - Preliminary piling as a separate operation in advance of the main piling	no	1	_____ / _____	_____ / _____		€202.38	€202.38	
1/3/1600		Moving piling plant - Bored cast-in-place piles - 800mm diameter - Main piling	no	10	_____ / _____	_____ / _____		€202.38	€2,023.82	
1/3/1600		Cast-in-place Piles								
1/3/1600		Pile shafts - Vertical - Reinforced concrete piles - 800mm diameter - Pile shafts exceeding 20 metres in length but not exceeding 25 metres - Preliminary piling as a separate operation in advance of the main piling	m	21.5	_____ / _____	_____ / _____		€378.49	€8,137.48	
1/3/1600		Pile shafts - Vertical - Reinforced concrete piles - 800mm diameter - Pile shafts exceeding 20 metres in length but not exceeding 25 metres - Main piling	m	215	_____ / _____	_____ / _____		€378.49	€81,374.78	
1/3/1600		Reinforcement for Cast-in-place Piles								
1/3/1600		Bar reinforcement - Nominal size 20 millimetres and over - Grade B500B - Bars not exceeding 12 metres in length	t	4.7	_____ / _____	_____ / _____		€1,225.00	€5,757.50	
1/3/1600		Bar reinforcement - Nominal size 16 millimetres and under - Grade B500B - Bars not exceeding 12 metres in length	t	14	_____ / _____	_____ / _____		€1,225.00	€17,150.00	
1/3/1600		Proof Loading of Piles								
1/3/1600		Establishment of proof loading equipment - 800mm diameter bored cast-in-place piles - Preliminary piles - Maintained load - Vertical	item	1	_____ / _____	_____ / _____		€4,500.00	€4,500.00	
1/3/1600		Establishment of Integrity testing equipment - 800mm diameter bored cast-in-place piles - Preliminary piles - Sonic Echo testing - Vertical	item	1	_____ / _____	_____ / _____		€600.00	€600.00	
1/3/1600		Establishment of Integrity testing equipment - 800mm diameter bored cast-in-place piles - Main piles - Sonic Echo testing - Vertical	item	1	_____ / _____	_____ / _____		€600.00	€600.00	
1/3/1600		Proof loading piles - 800mm diameter bored cast-in-place piles - Preliminary piles - Maintained load - Vertical	no	1	_____ / _____	_____ / _____		€14,812.50	€14,812.50	
1/3/1600		Integrity testing of piles - Sonic Echo Testing - 800mm diameter bored cast-in-place piles - Preliminary piles	no	1	_____ / _____	_____ / _____		€22.50	€22.50	
1/3/1600		Integrity testing of piles - Sonic Echo Testing - 800mm diameter bored cast-in-place piles - Main piles	no	10	_____ / _____	_____ / _____		€22.50	€225.00	
		TOTAL CARRIED FORWARD TO Construction Heading 3 SUMMARY					_____ / _____			€168,401.45
1/3/1700		Series 1700: Structural Concrete								
1/3/1700		In Situ Concrete								
1/3/1700		In situ concrete - C40/50 Mix Foundation Pilecap, Abutment and Wingwalls	m ³	185	_____ / _____	_____ / _____		€137.50	€25,437.50	
1/3/1700		In situ concrete - ST1 Mix - Blinding Concrete 75mm or less in thickness	m ³	10	_____ / _____	_____ / _____		€82.50	€825.00	
1/3/1700		Surface Finish of Concrete - Formwork								
1/3/1700		Formwork - 300mm wide or less at any inclination - F1 finish	m ²	3	_____ / _____	_____ / _____		€47.50	€142.50	
1/3/1700		Formwork - Vertical more than 300mm wide - F1 finish	m ²	100	_____ / _____	_____ / _____		€47.50	€4,750.00	
1/3/1700		Formwork - Vertical more than 300mm wide - F4 finish	m ²	145	_____ / _____	_____ / _____		€100.00	€14,500.00	
1/3/1700		Formwork - Horizontal more than 300mm wide - F4 finish	m ²	11	_____ / _____	_____ / _____		€110.00	€1,210.00	
1/3/1700		Steel Reinforcement for Structures								
1/3/1700		Bar reinforcement - Nominal size 16 millimetres and under - Grade B500B - Bars not exceeding 12 metres in length	t	7.3	_____ / _____	_____ / _____		€1,225.00	€8,942.50	
1/3/1700		Bar reinforcement - Nominal size 20 millimetres and over - Grade B500B - Bars not exceeding 12 metres in length	t	21.8	_____ / _____	_____ / _____		€1,225.00	€26,705.00	
		TOTAL CARRIED FORWARD TO Construction Heading 3 SUMMARY					_____ / _____			€82,512.50
1/3/1800		Series 1800: Structural Steelwork								
1/3/1800		Miscellaneous Metalwork								
1/3/1800		Miscellaneous metalwork - Access manhole to abutment gallery	no	1	_____ / _____	_____ / _____		€1,890.00	€1,890.00	
1/3/1800		Miscellaneous metalwork - Access manhole ladder	no	5	_____ / _____	_____ / _____		€630.00	€3,150.00	
		TOTAL CARRIED FORWARD TO Construction Heading 3 SUMMARY					_____ / _____			€5,040.00
1/3/2000		Series 2000: Waterproofing for Structures								
1/3/2000		Waterproofing								
1/3/2000		Waterproofing - Epoxy resin MCDUR 1680 or similar approved - More than 300mm wide horizontal or at any inclination up to and including 30° to the horizontal	m ²	50	_____ / _____	_____ / _____		€13.50	€675.00	
1/3/2000		Waterproofing - Epoxy resin MCDUR 1680 or similar approved - More than 300mm wide at any inclination more than 30° up to and including 90° to the horizontal	m ²	40	_____ / _____	_____ / _____		€13.50	€540.00	
1/3/2000		Waterproofing - Spray applied membrane - More than 300mm wide horizontal or at any inclination up to and including 30° to the horizontal	m ²	90	_____ / _____	_____ / _____		€32.00	€2,880.00	
1/3/2000		Waterproofing - Spray applied membrane - More than 300mm wide at any inclination more than 30° up to and including 90° to the horizontal	m ²	210	_____ / _____	_____ / _____		€33.00	€6,930.00	
1/3/2000		Waterproofing - Spray applied membrane - 300mm wide or less at any inclination	m ²	3	_____ / _____	_____ / _____		€33.00	€99.00	
		TOTAL CARRIED FORWARD TO Construction Heading 3 SUMMARY					_____ / _____			€11,124.00

Dodder Public Transportation Opening Bridge								Cost Estimate		
Bill Part 1: Dodder Public Transportation Bridge								Rate	Amount €	Totals €
Bill Part/ Constr Heading/ Series	Item No.	Item Description	Unit	Quantity	Rate	Amount €	Totals €			
1/3/2300		Series 2300: Bridge Expansion Joints and Sealing of Gaps								
1/3/2300		Sealing of Gaps								
1/3/2300		Joint sealant - Polysulphide sealant between pilecap and sheet pile wall - 25mm thick	m	45	_____ / _____	_____ / _____		€17.00	€765.00	
		TOTAL CARRIED FORWARD TO Construction Heading 3 SUMMARY					_____ / _____			€765.00

Dodder Public Transportation Opening Bridge										
Bill Part 1: Dodder Public Transportation Bridge										
Bill Part/ Constr Heading/ Series	Item No.	Item Description	Unit	Quantity	Rate	Amount €	Totals €	Cost Estimate		
								Rate	Amount €	Totals €
		Construction Heading 3: Substructure End Supports - Ringsend Side - Summary								
1/3/500		Series 500: Drainage and Service Ducts					_____ / _____			€756.00
1/3/600		Series 600: Earthworks					_____ / _____			€21,442.26
1/3/1600		Series 1600: Piling and Embedded Retaining Walls					_____ / _____			€168,401.45
1/3/1700		Series 1700: Structural Concrete					_____ / _____			€82,512.50
1/3/1800		Series 1800: Structural Steelwork					_____ / _____			€5,040.00
1/3/2000		Series 2000: Waterproofing for Structures					_____ / _____			€11,124.00
1/3/2300		Series 2300: Bridge Expansion Joints and Sealing of Gaps					_____ / _____			€765.00
		TOTAL CARRIED FORWARD TO Bill Part 1 SUMMARY					_____ / _____			€290,041.21

Dodder Public Transportation Opening Bridge								Cost Estimate		
Bill Part 1: Dodder Public Transportation Bridge								Rate	Amount €	Totals €
Bill Part/ Constr Heading/ Series	Item No.	Item Description	Unit	Quantity	Rate	Amount €	Totals €	Rate	Amount €	Totals €
Construction Heading 4: Substructure - Intermediate Support West										
Series 100: Preliminaries										
Special Preliminaries - General										
1/4/100		Cofferdam construction at intermediate support west; dredging and formation preparation for pilecap construction and removal after construction	item	1	_____ / _____	_____ / _____		€550,000.00	€550,000.00	
TOTAL CARRIED FORWARD TO Construction Heading 4 SUMMARY										€550,000.00
Series 600: Earthworks										
Excavation										
1/4/600		Excavation - Unacceptable Material Class U1 - Structural foundations - 0 metres to 3 metres in depth	m ³	1000	_____ / _____	_____ / _____		€7.50	€7,500.00	
1/4/600		Excavation - Unacceptable Material Class U1 - Structural foundations - 3 metres to 6 metres in depth	m ³	35	_____ / _____	_____ / _____		€7.50	€262.50	
Disposal of Material										
1/4/600		Disposal - Unacceptable material Class U1	m ³	1035	_____ / _____	_____ / _____		€14.50	€15,007.50	
TOTAL CARRIED FORWARD TO Construction Heading 4 SUMMARY										€22,770.00
Series 1600: Piling and Embedded Retaining Walls										
Piling Plant										
1/4/1600		Establishment of piling plant - Bored cast-in-place piles - 800mm Diameter - Preliminary piling as a separate operation in advance of the main piling	no	1	_____ / _____	_____ / _____		€16,497.75	€16,497.75	
1/4/1600		Establishment of piling plant - Bored cast-in-place piles - 800mm diameter - Main piling	no	1	_____ / _____	_____ / _____		€16,497.75	€16,497.75	
1/4/1600		Moving piling plant - Bored cast-in-place piles - 800mm Diameter - Preliminary piling as a separate operation in advance of the main piling	no	1	_____ / _____	_____ / _____		€202.38	€202.38	
1/4/1600		Moving piling plant - Bored cast-in-place piles - 800mm diameter - Main piling	no	32	_____ / _____	_____ / _____		€202.38	€6,476.22	
Cast-in-place Piles										
1/4/1600		Pile shafts - Vertical - Reinforced concrete piles - 800mm diameter - Pile shafts exceeding 15 metres in length but not exceeding 20 metres - Preliminary piling as a separate operation in advance of the main piling	m	16.5	_____ / _____	_____ / _____		€378.49	€6,245.04	
1/4/1600		Pile shafts - Vertical - Reinforced concrete piles - 800mm diameter - Pile shafts exceeding 15 metres in length but not exceeding 20 metres - Main piling	m	528	_____ / _____	_____ / _____		€378.49	€199,841.33	
Reinforcement for Cast-in-place Piles										
1/4/1600		Bar reinforcement - Nominal size 20 millimetres and over - Grade B500B - Bars not exceeding 12 metres in length	t	10.8	_____ / _____	_____ / _____		€1,225.00	€13,230.00	
1/4/1600		Bar reinforcement - Nominal size 16 millimetres and under - Grade B500B - Bars not exceeding 12 metres in length	t	32.3	_____ / _____	_____ / _____		€1,225.00	€39,567.50	
Proof Loading of Piles										
1/4/1600		Establishment of proof loading equipment - 800mm diameter bored cast-in-place piles - Preliminary piles - Maintained load - Vertical	item	1	_____ / _____	_____ / _____		€4,500.00	€4,500.00	
1/4/1600		Establishment of Integrity testing equipment - 800mm diameter bored cast-in-place piles - Preliminary piles - Sonic Echo testing - Vertical	item	1	_____ / _____	_____ / _____		€600.00	€600.00	
1/4/1600		Establishment of Integrity testing equipment - 800mm diameter bored cast-in-place piles - Main piles - Sonic Echo testing - Vertical	item	1	_____ / _____	_____ / _____		€600.00	€600.00	
1/4/1600		Proof loading piles - 800mm diameter bored cast-in-place piles - Preliminary piles - Maintained load - Vertical	no	1	_____ / _____	_____ / _____		€14,812.50	€14,812.50	
1/4/1600		Integrity testing of piles - Sonic Echo Testing - 800mm diameter bored cast-in-place piles - Preliminary piles	no	1	_____ / _____	_____ / _____		€22.50	€22.50	
1/4/1600		Integrity testing of piles - Sonic Echo Testing - 800mm diameter bored cast-in-place piles - Main piles	no	32	_____ / _____	_____ / _____		€22.50	€720.00	
TOTAL CARRIED FORWARD TO Construction Heading 4 SUMMARY										€319,812.96
Series 1700: Structural Concrete										
In Situ Concrete										
1/4/1700		In situ concrete - C40/50 Mix Pilecap and Bascule Pier	m ³	2250	_____ / _____	_____ / _____		€137.50	€309,375.00	
1/4/1700		In situ concrete - Mix ST1 - Blinding Concrete 75mm or less in thickness	m ³	25	_____ / _____	_____ / _____		€82.50	€2,062.50	
Surface Finish of Concrete - Formwork										
1/4/1700		Formwork - Vertical more than 300mm wide - F1 finish	m ²	110	_____ / _____	_____ / _____		€47.50	€5,225.00	
1/4/1700		Formwork - Vertical more than 300mm wide - F4 finish	m ²	1650	_____ / _____	_____ / _____		€100.00	€165,000.00	
1/4/1700		Patterned and profile work - Inclined, Curved - F4 finish	m ²	760	_____ / _____	_____ / _____		€209.69	€159,362.50	
1/4/1700		Formwork - Horizontal more than 300mm wide - F4 finish	m ²	279	_____ / _____	_____ / _____		€110.00	€30,690.00	
1/4/1700		Formwork - Horizontal less than 300mm wide - F4 finish	m ²	3	_____ / _____	_____ / _____		€110.00	€330.00	
Steel Reinforcement for Structures										
1/4/1700		Bar reinforcement - Nominal size 16 millimetres and under - Grade B500B - Bars not exceeding 12 metres in length	t	88.4	_____ / _____	_____ / _____		€1,225.00	€108,290.00	
1/4/1700		Bar reinforcement - Nominal size 20 millimetres and over - Grade B500B - Bars not exceeding 12 metres in length	t	265	_____ / _____	_____ / _____		€1,225.00	€324,625.00	
TOTAL CARRIED FORWARD TO Construction Heading 4 SUMMARY										€1,104,960.00
Series 2000: Waterproofing for Structures										
Waterproofing										
1/4/2000		Waterproofing - Epoxy resin MCDUR 1680 or similar approved - More than 300mm wide horizontal or at any inclination up to and including 30° to the horizontal	m ²	330	_____ / _____	_____ / _____		€13.50	€4,455.00	
1/4/2000		Waterproofing - Epoxy resin MCDUR 1680 or similar approved - More than 300mm wide at any inclination more than 30° up to and including 90° to the horizontal	m ²	110	_____ / _____	_____ / _____		€13.50	€1,485.00	
1/4/2000		Waterproofing - Spray applied membrane - More than 300mm wide horizontal or at any inclination up to and including 30° to the horizontal	m ²	1365	_____ / _____	_____ / _____		€32.00	€43,680.00	
1/4/2000		Waterproofing - Spray applied membrane - More than 300mm wide at any inclination more than 30° up to and including 90° to the horizontal	m ²	1670	_____ / _____	_____ / _____		€33.00	€55,110.00	
1/4/2000		Waterproofing - Spray applied membrane - 300mm wide or less at any inclination	m ²	3	_____ / _____	_____ / _____		€33.00	€99.00	
TOTAL CARRIED FORWARD TO Construction Heading 4 SUMMARY										€104,829.00

Dodder Public Transportation Opening Bridge										
Bill Part 1: Dodder Public Transportation Bridge										
Bill Part/ Constr Heading/ Series	Item No.	Item Description	Unit	Quantity	Rate	Amount €	Totals €	Cost Estimate		
								Rate	Amount €	Totals €
		Construction Heading 4: Substructure - Intermediate								
		Support West - Summary								
1/4/100		Series 100: Preliminaries					_____ / _____			€550,000.00
1/4/600		Series 600: Earthworks					_____ / _____			€22,770.00
1/4/1600		Series 1600: Piling and Embedded Retaining Walls					_____ / _____			€319,812.96
1/4/1700		Series 1700: Structural Concrete					_____ / _____			€1,104,960.00
1/4/2000		Series 2000: Waterproofing for Structures					_____ / _____			€104,829.00
		TOTAL CARRIED FORWARD TO Bill Part 1 SUMMARY					_____ / _____			€2,102,371.96

Dodder Public Transportation Opening Bridge								Cost Estimate		
Bill Part 1: Dodder Public Transportation Bridge								Rate	Amount €	Totals €
Bill Part/ Constr Heading/ Series	Item No.	Item Description	Unit	Quantity	Rate	Amount €	Totals €	Rate	Amount €	Totals €
		Construction Heading 5: Substructure - Intermediate Support East								
1/5/100		Series 100: Preliminaries								
1/5/100		Special Preliminaries - General								
1/5/100		Cofferdam construction at intermediate support east, dredging and formation preparation for pilecap construction and removal after construction	item	1	_____ / _____	_____ / _____		€550,000.00	€550,000.00	
		TOTAL CARRIED FORWARD TO Construction Heading 5 SUMMARY					_____ / _____			€550,000.00
1/5/600		Series 600: Earthworks								
1/5/600		Excavation								
1/5/600		Excavation - Unacceptable Material Class U1 - Structural foundations - 0 metres to 3 metres in depth	m ³	165	_____ / _____	_____ / _____		€7.50	€1,237.50	
1/5/600		Disposal of Material								
1/5/600		Disposal - Unacceptable material Class U1	m ³	165	_____ / _____	_____ / _____		€14.50	€2,392.50	
		TOTAL CARRIED FORWARD TO Construction Heading 5 SUMMARY					_____ / _____			€3,630.00
1/5/1600		Series 1600: Piling and Embedded Retaining Walls								
1/5/1600		Piling Plant								
1/5/1600		Establishment of piling plant - Bored cast-in-place piles - 800mm Diameter - Preliminary piling as a separate operation in advance of the main piling	no	1	_____ / _____	_____ / _____		€16,497.75	€16,497.75	
1/5/1600		Establishment of piling plant - Bored cast-in-place piles - 800mm diameter - Main piling	no	1	_____ / _____	_____ / _____		€16,497.75	€16,497.75	
1/5/1600		Moving piling plant - Bored cast-in-place piles - 800mm Diameter - Preliminary piling as a separate operation in advance of the main piling	no	1	_____ / _____	_____ / _____		€202.38	€202.38	
1/5/1600		Moving piling plant - Bored cast-in-place piles - 800mm diameter - Main piling	no	8	_____ / _____	_____ / _____		€202.38	€1,619.05	
1/5/1600		Cast-in-place Piles								
1/5/1600		Pile shafts - Vertical - Reinforced concrete piles - 800mm diameter - Pile shafts exceeding 15 metres in length but not exceeding 20 metres - Preliminary piling as a separate operation in advance of the main piling	m	16	_____ / _____	_____ / _____		€378.49	€6,055.80	
1/5/1600		Pile shafts - Vertical - Reinforced concrete piles - 800mm diameter - Pile shafts exceeding 15 metres in length but not exceeding 20 metres - Main piling	m	128	_____ / _____	_____ / _____		€378.49	€48,446.38	
1/5/1600		Reinforcement for Cast-in-place Piles								
1/5/1600		Bar reinforcement - Nominal size 20 millimetres and over - Grade B500B - Bars not exceeding 12 metres in length	t	2.9	_____ / _____	_____ / _____		€1,225.00	€3,552.50	
1/5/1600		Bar reinforcement - Nominal size 16 millimetres and under - Grade B500B - Bars not exceeding 12 metres in length	t	8.6	_____ / _____	_____ / _____		€1,225.00	€10,535.00	
1/5/1600		Proof Loading of Piles								
1/5/1600		Establishment of proof loading equipment - 800mm diameter bored cast-in-place piles - Preliminary piles - Maintained load - Vertical	item	1	_____ / _____	_____ / _____		€4,500.00	€4,500.00	
1/5/1600		Establishment of Integrity testing equipment - 800mm diameter bored cast-in-place piles - Preliminary piles - Sonic Echo testing - Vertical	item	1	_____ / _____	_____ / _____		€600.00	€600.00	
1/5/1600		Establishment of Integrity testing equipment - 800mm diameter bored cast-in-place piles - Main piles - Sonic Echo testing - Vertical	item	1	_____ / _____	_____ / _____		€600.00	€600.00	
1/5/1600		Proof loading piles - 800mm diameter bored cast-in-place piles - Preliminary piles - Maintained load - Vertical	no	1	_____ / _____	_____ / _____		€14,812.50	€14,812.50	
1/5/1600		Integrity testing of piles - Sonic Echo Testing - 800mm diameter bored cast-in-place piles - Preliminary piles	no	1	_____ / _____	_____ / _____		€22.50	€22.50	
1/5/1600		Integrity testing of piles - Sonic Echo Testing - 800mm diameter bored cast-in-place piles - Main piles	no	8	_____ / _____	_____ / _____		€22.50	€180.00	
		TOTAL CARRIED FORWARD TO Construction Heading 5 SUMMARY					_____ / _____			€124,121.61
1/5/1700		Series 1700: Structural Concrete								
1/5/1700		In Situ Concrete								
1/5/1700		In situ concrete - C40/50 Mix Pilecap and Piers	m ³	190	_____ / _____	_____ / _____		€137.50	€26,125.00	
1/5/1700		In situ concrete - ST1 Mix - Blinding Concrete 75mm or less in thickness	m ³	6	_____ / _____	_____ / _____		€82.50	€495.00	
1/5/1700		Surface Finish of Concrete - Formwork								
1/5/1700		Formwork - Vertical more than 300mm wide - F1 finish	m ²	55	_____ / _____	_____ / _____		€47.50	€2,612.50	
1/5/1700		Formwork - Vertical more than 300mm wide - F4 finish	m ²	100	_____ / _____	_____ / _____		€152.50	€15,250.00	
1/5/1700		Patterned and profile work - Vertical, Curved - F4 finish	m ²	40	_____ / _____	_____ / _____		€209.69	€8,387.50	
1/5/1700		Steel Reinforcement for Structures								
1/5/1700		Bar reinforcement - Nominal size 16 millimetres and under - Grade B500B - Bars not exceeding 12 metres in length	t	6.7	_____ / _____	_____ / _____		€1,225.00	€8,207.50	
1/5/1700		Bar reinforcement - Nominal size 20 millimetres and over - Grade B500B - Bars not exceeding 12 metres in length	t	20.1	_____ / _____	_____ / _____		€1,225.00	€24,622.50	
		TOTAL CARRIED FORWARD TO Construction Heading 5 SUMMARY					_____ / _____			€85,700.00
1/5/2000		Series 2000: Waterproofing for Structures								
1/5/2000		Waterproofing								
1/5/2000		Waterproofing - Epoxy resin MCDUR 1680 or similar approved - More than 300mm wide horizontal or at any inclination up to and including 30° to the horizontal	m ²	70	_____ / _____	_____ / _____		€13.50	€945.00	
1/5/2000		Waterproofing - Epoxy resin MCDUR 1680 or similar approved - More than 300mm wide at any inclination more than 30° up to and including 90° to the horizontal	m ²	55	_____ / _____	_____ / _____		€13.50	€742.50	
1/5/2000		Waterproofing - Spray applied membrane - More than 300mm wide horizontal or at any inclination up to and including 30° to the horizontal	m ²	70	_____ / _____	_____ / _____		€32.00	€2,240.00	
1/5/2000		Waterproofing - Spray applied membrane - More than 300mm wide at any inclination more than 30° up to and including 90° to the horizontal	m ²	145	_____ / _____	_____ / _____		€33.00	€4,785.00	
		TOTAL CARRIED FORWARD TO Construction Heading 5 SUMMARY					_____ / _____			€8,712.50

Dodder Public Transportation Opening Bridge										
Bill Part 1: Dodder Public Transportation Bridge										
Bill Part/ Constr Heading/ Series	Item No.	Item Description	Unit	Quantity	Rate	Amount €	Totals €	Cost Estimate		
								Rate	Amount €	Totals €
		Construction Heading 5: Substructure - Intermediate								
		Support East - Summary								
1/5/100		Series 100: Preliminaries					_____ / _____			€550,000.00
1/5/600		Series 600: Earthworks					_____ / _____			€3,630.00
1/5/1600		Series 1600: Piling and Embedded Retaining Walls					_____ / _____			€124,121.61
1/5/1700		Series 1700: Structural Concrete					_____ / _____			€85,700.00
1/5/2000		Series 2000: Waterproofing for Structures					_____ / _____			€8,712.50
		TOTAL CARRIED FORWARD TO Bill Part 1 SUMMARY					_____ / _____			€772,164.11

Dodder Public Transportation Opening Bridge							Cost Estimate			
Bill Part 1: Dodder Public Transportation Bridge							Rate	Amount €	Totals €	
Bill Part/ Constr Heading/ Series	Item No.	Item Description	Unit	Quantity	Rate	Amount €	Totals €	Rate	Amount €	Totals €
Construction Heading 6: Superstructure - Fixed Span										
Series 1700: Structural Concrete										
In Situ Concrete										
1/6/1700		In situ concrete - C40/50 Mix Concrete Deck	m ³	140	_____ / _____	_____ / _____		€125.00	€17,500.00	
1/6/1700		In situ concrete - Fosroc Conbextra GP or equivalent in bearing plinths	m ³	2	_____ / _____	_____ / _____		€220.00	€440.00	
Surface Finish of Concrete - Formwork										
1/6/1700		Formwork - 300mm wide or less at any inclination - F4 finish	m ²	13	_____ / _____	_____ / _____		€100.00	€1,300.00	
1/6/1700		Formwork - Vertical more than 300mm wide - F4 finish	m ²	90	_____ / _____	_____ / _____		€100.00	€9,000.00	
1/6/1700		Formwork - Horizontal more than 300mm wide - F4 finish	m ²	215	_____ / _____	_____ / _____		€110.00	€23,650.00	
Steel Reinforcement for Structures										
1/6/1700		Bar reinforcement - Nominal size 16 millimetres and under - Grade B500B - Bars not exceeding 12 metres in length	t	6	_____ / _____	_____ / _____		€1,225.00	€7,350.00	
1/6/1700		Bar reinforcement - Nominal size 20 millimetres and over - Grade B500B - Bars not exceeding 12 metres in length	t	16.5	_____ / _____	_____ / _____		€1,225.00	€20,212.50	
TOTAL CARRIED FORWARD TO Construction Heading 6 SUMMARY							_____ / _____			€79,452.50
Series 1800: Structural Steelwork										
Fabrication of Steelwork										
1/6/1800		Fabrication - Main members - Box girders - S355 grade stiffened steel box girder - Tapering depth along bridge length	t	635	_____ / _____	_____ / _____		€5,529.23	€3,511,062.45	
Erection of Steelwork										
1/6/1800		Trial erection at the place of fabrication - Main deck box girder	t	635	_____ / _____	_____ / _____		€347.33	€220,556.46	
1/6/1800		Permanent erection - Main deck box girder	t	635	_____ / _____	_____ / _____		€291.35	€185,009.66	
Provision for future light rail support										
1/6/1800		Single track	m	230	_____ / _____	_____ / _____		€1,003.00	€230,690.00	
TOTAL CARRIED FORWARD TO Construction Heading 6 SUMMARY							_____ / _____			€4,147,318.57
Series 1900: Protection of Steelwork against Corrosion Protective System										
1/6/1900		Protective system - Blast clean surface preparation to BS 7079, removal of defects to EN10025 and application of protective coatings	m ²	9625	_____ / _____	_____ / _____		€51.14	€492,234.05	
TOTAL CARRIED FORWARD TO Construction Heading 6 SUMMARY							_____ / _____			€492,234.05
Series 2000: Waterproofing for Structures										
Waterproofing										
1/6/2000		Waterproofing - Spray applied membrane - More than 300mm wide horizontal or at any inclination up to and including 30° to the horizontal	m ²	7	_____ / _____	_____ / _____		€32.00	€224.00	
1/6/2000		Waterproofing - Spray applied membrane - More than 300mm wide at any inclination more than 30° up to and including 90° to the horizontal	m ²	6	_____ / _____	_____ / _____		€33.00	€198.00	
1/6/2000		Waterproofing - Spray applied membrane - 300mm wide or less at any inclination	m ²	4	_____ / _____	_____ / _____		€33.00	€132.00	
TOTAL CARRIED FORWARD TO Construction Heading 6 SUMMARY							_____ / _____			€554.00
Series 2100: Bridge Bearings										
Bearings										
1/6/2100		Bearings - Mechanical guided bearing at abutments	no	3	_____ / _____	_____ / _____		€12,600.00	€37,800.00	
1/6/2100		Bearings - Mechanical fixed bearing at east abutment	no	1	_____ / _____	_____ / _____		€6,300.00	€6,300.00	
1/6/2100		Bearings - Mechanical free bearing at east pier	no	1	_____ / _____	_____ / _____		€12,600.00	€12,600.00	
1/6/2100		Bearings - Mechanical guided bearing at east pier	no	1	_____ / _____	_____ / _____		€12,600.00	€12,600.00	
1/6/2100		Installation of bearings - Mechanical guided bearing at abutments	no	3	_____ / _____	_____ / _____		€143.70	€431.10	
1/6/2100		Installation of bearings - Mechanical fixed bearing at east abutment	no	1	_____ / _____	_____ / _____		€131.20	€131.20	
1/6/2100		Installation of bearings - Mechanical free bearing at east pier	no	1	_____ / _____	_____ / _____		€143.70	€143.70	
1/6/2100		Installation of bearings - Mechanical guided bearing at east pier	no	1	_____ / _____	_____ / _____		€143.70	€143.70	
TOTAL CARRIED FORWARD TO Construction Heading 6 SUMMARY							_____ / _____			€70,149.71
Series 2300: Bridge Expansion Joints and Sealing of Gaps										
Bridge Deck Expansion Joints										
1/6/2300		Bridge deck expansion joints - Proprietary type for steel deck - 20.7m approx. length - 150mm gap width at Ringsend Abutment	no	1	_____ / _____	_____ / _____		€2,494.80	€2,494.80	
1/6/2300		Bridge deck expansion joints - Proprietary type to concrete steel deck transition - 20.7m approx. length - 100mm gap width at Pier B2B	no	1	_____ / _____	_____ / _____		€2,494.80	€2,494.80	
TOTAL CARRIED FORWARD TO Construction Heading 6 SUMMARY							_____ / _____			€4,989.60

Dodder Public Transportation Opening Bridge										
Bill Part 1: Dodder Public Transportation Bridge										
Bill Part/ Constr Heading/ Series	Item No.	Item Description	Unit	Quantity	Rate	Amount €	Totals €	Cost Estimate		
								Rate	Amount €	Totals €
		Construction Heading 6: Superstructure - Fixed Span - Summary								
1/6/1700		Series 1700: Structural Concrete					_____ / _____			€79,452.50
1/6/1800		Series 1800: Structural Steelwork					_____ / _____			€4,147,318.57
1/6/1900		Series 1900: Protection of Steelwork against Corrosion					_____ / _____			€492,234.05
1/6/2000		Series 2000: Waterproofing for Structures					_____ / _____			€554.00
1/6/2100		Series 2100: Bridge Bearings					_____ / _____			€70,149.71
1/6/2300		Series 2300: Bridge Expansion Joints and Sealing of Gaps					_____ / _____			€4,989.60
		TOTAL CARRIED FORWARD TO Bill Part 1 SUMMARY					_____ / _____			€4,794,698.42

Dodder Public Transportation Opening Bridge										
Bill Part 1: Dodder Public Transportation Bridge										
Bill Part/ Constr Heading/ Series	Item No.	Item Description	Unit	Quantity	Rate	Amount €	Totals €	Cost Estimate		
								Rate	Amount €	Totals €
Construction Heading 7: Superstructure - Opening Span										
Series 1700: Structural Concrete										
1/6/1700		In Situ Concrete								
1/6/1700		In situ concrete - Counterweight	m ³	185	_____ / ____	_____ / ____		€125.00	€23,125.00	
		TOTAL CARRIED FORWARD TO Construction Heading 7 SUMMARY								€23,125.00
Series 1800: Structural Steelwork										
Fabrication of Steelwork										
1/7/1800		Fabrication - Main members - Box girders - S355 grade stiffened steel box girder - Tapering depth along bridge length	t	600	_____ / ____	_____ / ____		€6,000.00	€3,600,000.00	
Erection of Steelwork										
1/7/1800		Trial erection at the place of fabrication - Main deck box girder	t	600	_____ / ____	_____ / ____		€347.33	€208,399.80	
1/7/1800		Permanent erection - Main deck box girder	t	600	_____ / ____	_____ / ____		€291.35	€174,812.28	
Provision for future light rail support										
1/7/1800		Single track	m	155	_____ / ____	_____ / ____		€1,003.00	€155,465.00	
Miscellaneous Metalwork										
1/7/1800		Metal plate counterweight allowance for lifting span	t	200	_____ / ____	_____ / ____		€1,500.00	€300,000.00	
		TOTAL CARRIED FORWARD TO Construction Heading 7 SUMMARY					_____ / ____			€4,438,677.08
Series 1900: Protection of Steelwork against Corrosion Protective System										
1/7/1900		Protective system - Blast clean surface preparation to BS 7079, removal of defects to EN10025 and application of protective coatings	m ²	5715	_____ / ____	_____ / ____		€51.14	€292,271.96	
		TOTAL CARRIED FORWARD TO Construction Heading 7 SUMMARY					_____ / ____			€292,271.96
Series 2100: Bridge Bearings										
Bearings										
1/7/2100		Bearings - Mechanical guided bearing at opening span pier	no	1	_____ / ____	_____ / ____		€12,600.00	€12,600.00	
1/7/2100		Bearings - Mechanical free bearing at opening span pier	no	1	_____ / ____	_____ / ____		€12,600.00	€12,600.00	
1/7/2100		Installation of bearings - Mechanical guided bearing at opening span pier	no	1	_____ / ____	_____ / ____		€143.70	€143.70	
1/7/2100		Installation of bearings - Mechanical free bearing at opening span pier	no	1	_____ / ____	_____ / ____		€143.70	€143.70	
		TOTAL CARRIED FORWARD TO Construction Heading 7 SUMMARY					_____ / ____			€25,487.40
Series 2300: Bridge Expansion Joints and Sealing of Gaps										
Bridge Deck Expansion Joints										
1/7/2300		Bridge deck expansion joints - Proprietary type for steel deck - 20.7m approx. length - 50mm gap width at SJRQ Abutment	no	1	_____ / ____	_____ / ____		€2,494.80	€2,494.80	
1/7/2300		Bridge deck expansion joints - Proprietary J seal type at opening span - 37.5m approx. length - 150mm gap width at Pier B2A	no	1	_____ / ____	_____ / ____		€10,000.00	€10,000.00	
		TOTAL CARRIED FORWARD TO Construction Heading 7 SUMMARY					_____ / ____			€12,494.80
Series 2700: Watermains, Utilities and Accommodation Works										
Lifting Span Mechanical Equipment & Control										
1/7/2700		Opening mechanical, electrical and hydraulic equipment and control equipment	item	1	_____ / ____	_____ / ____		€4,500,000.00	€4,500,000.00	
		TOTAL CARRIED FORWARD TO Construction Heading 7 SUMMARY					_____ / ____			€4,500,000.00

Dodder Public Transportation Opening Bridge										
Bill Part 1: Dodder Public Transportation Bridge										
Bill Part/ Constr Heading/ Series	Item No.	Item Description	Unit	Quantity	Rate	Amount €	Totals €	Cost Estimate		
								Rate	Amount €	Totals €
		Construction Heading 7: Superstructure - Opening Span - Summary								
1/6/1700		Series 1700: Structural Concrete					_____ / _____			€23,125.00
1/7/1800		Series 1800: Structural Steelwork					_____ / _____			€4,438,677.08
1/7/1900		Series 1900: Protection of Steelwork against Corrosion					_____ / _____			€292,271.96
1/7/2100		Series 2100: Bridge Bearings					_____ / _____			€25,487.40
1/7/2300		Series 2300: Bridge Expansion Joints and Sealing of Gaps					_____ / _____			€12,494.80
1/7/2700		Series 2700: Watermains, Utilities and Accommodation Works					_____ / _____			€4,500,000.00
		TOTAL CARRIED FORWARD TO Bill Part 1 SUMMARY					_____ / _____			€9,292,056.24

Dodder Public Transportation Opening Bridge							Cost Estimate			
Bill Part 1: Dodder Public Transportation Bridge							Rate	Amount €	Totals €	
Bill Part/ Constr Heading/ Series	Item No.	Item Description	Unit	Quantity	Rate	Amount €	Totals €	Rate	Amount €	Totals €
		Construction Heading 8: Finishings								
1/8/400		Series 400: Road Restraint Systems (Vehicle and Pedestrian)								
1/8/400		Safety Barriers								
1/8/400		Safety barrier: barrier between cycle track and carriageway on fixed span; 600 x 500 (height varies); handrail on top	m	55	_____ / _____	_____ / _____		€255.00	€14,025.00	
1/8/400		Safety barrier; vehicle barriers; recessed into carriageway; mechanically raised/lowered when opening span in operation; to suit single carriageway	no	4	_____ / _____	_____ / _____		€10,000.00	€40,000.00	
1/8/400		Vehicle Parapet Systems								
1/8/400		Bespoke parapets design by the Employer - To edge of bridge, fitted with wind shielding where required - Straight or curved exceeding 50 metres radius	m	195	_____ / _____	_____ / _____		€3,500.00	€682,500.00	
1/8/400		Pedestrian Parapets, Pedestrian Guardrails and Handrails								
1/8/400		Pedestrian gates/barriers to footpath/cycle track; mechanically opened/closed when opening span in operation	no	4	_____ / _____	_____ / _____		€10,000.00	€40,000.00	
		TOTAL CARRIED FORWARD TO Construction Heading 8 SUMMARY					_____ / _____			€776,525.00
1/8/500		Series 500: Drainage and Service Ducts								
1/8/500		Proprietary Prefabricated Buried Modular System								
1/8/500		Sump pump, pipes and fittings to connect with combined bridge deck drainage system, housed in bascule pier.	no	1	_____ / _____	_____ / _____		€10,000.00	€10,000.00	
		TOTAL CARRIED FORWARD TO Construction Heading 8 SUMMARY					_____ / _____			€10,000.00
1/8/700		Series 700: Pavements								
1/8/700		Pavement								
1/8/700		Pavement - Wearing course - Combined waterproofing and surfacing for steel deck, 16mm thick - Carriageway	m ²	625	_____ / _____	_____ / _____		€500.00	€312,500.00	
		TOTAL CARRIED FORWARD TO Construction Heading 8 SUMMARY					_____ / _____			€312,500.00
1/8/1100		Series 1100: Kerbs, Footways and Paved Areas								
1/8/1100		Kerbs, Channels, Edgings, Combined Drainage and Kerb Blocks and Linear Drainage Channel Systems								
1/8/1100		Combined drainage and kerb blocks - 125mm high combined bridge deck drainage system as shown on drawings - Straight	m	195	_____ / _____	_____ / _____		€122.50	€23,887.50	
1/8/1100		Footways and Paved Areas								
1/8/1100		Footways - Footpath/ cycletrack - Combined waterproofing and surfacing for steel deck, 7mm thick in cycleway - Surfaces sloping at 10° or less to the horizontal	m ²	1070	_____ / _____	_____ / _____		€235.50	€251,985.00	
1/8/1100		Rubbing strip - 500mm width x 125mm high formed in situ concrete	m	74	_____ / _____	_____ / _____		€125.00	€9,250.00	
1/8/1100		Rubbing strip - 1100mm width x 125mm high formed in situ concrete	m	26	_____ / _____	_____ / _____		€125.00	€3,250.00	
		TOTAL CARRIED FORWARD TO Construction Heading 8 SUMMARY					_____ / _____			€288,372.50
1/8/1200		Series 1200: Traffic Signs and Road Markings								
1/8/1200		Traffic Signs								
1/8/1200		Traffic signs - General	item	1	_____ / _____	_____ / _____		€63,000.00	€63,000.00	
1/8/1200		Road Markings								
1/8/1200		Road markings - General	item	1	_____ / _____	_____ / _____		€18,900.00	€18,900.00	
		TOTAL CARRIED FORWARD TO Construction Heading 8 SUMMARY					_____ / _____			€81,900.00
1/8/1300		Series 1300: Road Lighting Columns and Brackets								
1/8/1300		Road Lighting Columns, Brackets and Wall Mountings								
1/8/1300		Road lighting columns and brackets - Low level LED lighting installation to parapet handrails and barriers; bridge soffits; uplighters to footpaths, cycle tracks and carriageways, CCTV, cabling and electrics for all	item	1	_____ / _____	_____ / _____		€400,000.00	€400,000.00	
		TOTAL CARRIED FORWARD TO Construction Heading 8 SUMMARY					_____ / _____			€400,000.00

Dodder Public Transportation Opening Bridge										
Bill Part 1: Dodder Public Transportation Bridge										
Bill Part/ Constr Heading/ Series	Item No.	Item Description	Unit	Quantity	Rate	Amount €	Totals €	Cost Estimate		
								Rate	Amount €	Totals €
		Construction Heading 8: Finishings - Summary								
1/8/400		Series 400: Road Restraint Systems (Vehicle and Pedestrian)					_____ / _____			€776,525.00
1/8/500		Series 500: Drainage and Service Ducts					_____ / _____			€10,000.00
1/8/700		Series 700: Pavements					_____ / _____			€312,500.00
1/8/1100		Series 1100: Kerbs, Footways and Paved Areas					_____ / _____			€288,372.50
1/8/1200		Series 1200: Traffic Signs and Road Markings					_____ / _____			€81,900.00
1/8/1300		Series 1300: Road Lighting Columns and Brackets					_____ / _____			€400,000.00
		TOTAL CARRIED FORWARD TO Bill Part 1 SUMMARY					_____ / _____			€1,869,297.50

Dodder Public Transportation Opening Bridge										
Bill Part 1: Dodder Public Transportation Bridge										
Bill Part/ Constr Heading/ Series	Item No.	Item Description	Unit	Quantity	Rate	Amount €	Totals €	Cost Estimate		
								Rate	Amount €	Totals €
		Bill Part 1: Dodder Public Transportation Bridge - Summary								
		Construction Heading 1: Preliminaries					_____ / _____			€605,700.00
		Construction Heading 2: Substructure End Supports - West Abutment SJRQ					_____ / _____			€504,579.99
		Construction Heading 3: Substructure End Supports - Ringsend Side					_____ / _____			€290,041.21
		Construction Heading 4: Substructure - Intermediate Support West					_____ / _____			€2,102,371.96
		Construction Heading 5: Substructure - Intermediate Support East					_____ / _____			€772,164.11
		Construction Heading 6: Superstructure - Fixed Span					_____ / _____			€4,794,698.42
		Construction Heading 7: Superstructure - Opening Span					_____ / _____			€9,292,056.24
		Construction Heading 8: Finishings					_____ / _____			€1,869,297.50
		Total Carried Forward to General Summary					_____ / _____			€20,230,909.43

Dodder Public Transportation Opening Bridge										
Bill Part 2: Eastern & Western Approach Roads										
Bill Part/ Constr Heading/ Series	Item No.	Item Description	Unit	Quantity	Rate	Amount €	Totals €	Cost Estimate		
								Rate	Amount €	Totals €
Construction Heading 1: Eastern Approach Road										
2/1/200		Series 200: Site Clearance								
2/1/200		Site Clearance								
2/1/200		General site clearance	m ²	2420	_____ / _____	_____ / _____		€0.11	€272.25	
2/1/200		Take Up or Down and Set Aside for Reuse or Remove to Store or Tip off Site								
2/1/200		Take up or down and set aside for reuse - Dodder Buoy	item	1	_____ / _____	_____ / _____		€315.00	€315.00	
2/1/200		Take up or down and set aside for reuse - Boat propeller	item	1	_____ / _____	_____ / _____		€189.00	€189.00	
2/1/200		Take up or down and remove to store off Site - Memorial items	item	1	_____ / _____	_____ / _____		€315.00	€315.00	
2/1/200		Take up or down and remove to store off Site - Ship mast	item	1	_____ / _____	_____ / _____		€315.00	€315.00	
2/1/200		Take up or down and remove to tip off Site - Blockwork	item	1	_____ / _____	_____ / _____		€44.10	€44.10	
2/1/200		Take up or down and remove to tip off Site - Posts and chain	item	1	_____ / _____	_____ / _____		€18.90	€18.90	
2/1/200		Take up or down and remove to tip off Site - Precast concrete slab paving, approx. 100mm thick	item	1	_____ / _____	_____ / _____		€12.60	€12.60	
		TOTAL CARRIED FORWARD TO Construction Heading 1 SUMMARY					_____ / _____			€1,481.85
2/1/300		Series 300: Fencing and Environmental Noise Barriers								
2/1/300		Fencing, Gates and Stiles								
2/1/300		Flood gates	no	1	_____ / _____	_____ / _____		€5,000.00	€5,000.00	
		TOTAL CARRIED FORWARD TO Construction Heading 1 SUMMARY								€5,000.00
2/1/400		Series 400: Road Restraint Systems (Vehicle and Pedestrian)								
2/1/400		Safety Barriers								
2/1/400		Safety barrier; standard socketed post foundation - Type N2W2 - Designed to be impacted on one side only - Straight or curved exceeding 120 metres radius	m	72	_____ / _____	_____ / _____		€255.00	€18,360.00	
2/1/400		Transitions								
2/1/400		Transitions between safety barriers and parapets - From single sided N2W2 to bridge parapet - Designed to be impacted on one side only - Straight or curved exceeding 120 metres radius	no	2	_____ / _____	_____ / _____		€1,800.00	€3,600.00	
2/1/400		Terminals								
2/1/400		Terminal; Single Sided Flex Beam - P1 - Designed to be impacted on one side only	no	2	_____ / _____	_____ / _____		€925.00	€1,850.00	
2/1/400		Pedestrian Parapets, Pedestrian Guardrails and Handrails								
2/1/400		Pedestrian Guardrails as shown on the drawings - 1000mm high	m	72	_____ / _____	_____ / _____		€3,500.00	€252,000.00	
		TOTAL CARRIED FORWARD TO Construction Heading 1 SUMMARY					_____ / _____			€275,810.00
2/1/500		Series 500: Drainage and Service Ducts								
2/1/500		Drains, Sewers, Piped Culverts and Service Ducts (Excluding Filter Drains, Narrow Filter Drains & Fin Drains)								
2/1/500		Drains or sewers - 450mm diameter - Depth to invert not exceeding 2m; Average depth <2.0m - uPVC drain - Bed Type S in trench	m	184	_____ / _____	_____ / _____		€158.15	€29,099.51	
2/1/500		Chambers and Gullies								
2/1/500		Chambers - Precast concrete chamber 1500mm diameter - Depth to invert exceeding 1 metre but not exceeding 2 metres D400 cover and frame	no	4	_____ / _____	_____ / _____		€597.00	€2,388.00	
2/1/500		Gullies - Precast concrete trapped gully - D400 hinged cover and frame	no	12	_____ / _____	_____ / _____		€975.00	€11,700.00	
		TOTAL CARRIED FORWARD TO Construction Heading 1 SUMMARY					_____ / _____			€43,187.51
2/1/600		Series 600: Earthworks								
2/1/600		Excavation								
2/1/600		Excavation - Unacceptable Material Class U1 - Cutting and other excavation - 0 metres to 3 metres in depth	m ³	335	_____ / _____	_____ / _____		€7.50	€2,512.50	
2/1/600		Disposal of Material								
2/1/600		Disposal - Unacceptable material Class U1	m ³	335	_____ / _____	_____ / _____		€14.50	€4,857.50	
2/1/600		Breaking up and Perforation of Redundant Pavements								
2/1/600		Breaking up of redundant pavements - Type, Existing paved areas and part of road - Depth exceeding 100mm but not exceeding 200mm	m ²	530	_____ / _____	_____ / _____		€19.02	€10,081.45	
		TOTAL CARRIED FORWARD TO Construction Heading 1 SUMMARY					_____ / _____			€17,451.45
2/1/700		Series 700: Pavements								
2/1/700		Pavement								
2/1/700		Pavement - Base course - Dense bitumen macadam 150mm thick with 28mm aggregate - In Eastern approach road carriageway	m ²	1225	_____ / _____	_____ / _____		€35.00	€42,875.00	
2/1/700		Pavement - Binder course - Dense macadam 60mm thick with 20mm aggregate - In Eastern approach road carriageway	m ²	1225	_____ / _____	_____ / _____		€26.00	€31,850.00	
2/1/700		Pavement - Surface course - Hot rolled asphalt 40mm thick with 10mm aggregate - In Eastern approach road carriageway	m ²	1225	_____ / _____	_____ / _____		€14.50	€17,762.50	
2/1/700		Surface Treatment								
2/1/700		Surface Dressing - Resin based surface treatment to cycleways - Colour TBC	m ²	1145	_____ / _____	_____ / _____		€25.96	€29,724.20	
		TOTAL CARRIED FORWARD TO Construction Heading 1 SUMMARY					_____ / _____			€122,211.70
2/1/1100		Series 1100: Kerbs, Footways and Paved Areas								
2/1/1100		Kerbs, Channels, Edgings, Combined Drainage and Kerb Blocks and Linear Drainage Channel Systems								
2/1/1100		Kerbs - Precast concrete kerb - Straight or curved exceeding 12 metres radius	m	240	_____ / _____	_____ / _____		€25.00	€6,000.00	
2/1/1100		Kerbs - Precast concrete kerb - Curved not exceeding 12 metres radius	m	9	_____ / _____	_____ / _____		€27.50	€247.50	
2/1/1100		Footways and Paved Areas								
2/1/1100		Paved areas - Splitter islands - Surfaces sloping at 10° or less to the horizontal	m ²	55	_____ / _____	_____ / _____		€31.00	€1,705.00	
2/1/1100		Footways - Footpath/ cycletrack; granular material Type 1 sub-base 150 thick, dense macadam binder course with 14 mm aggregate 40 thick, rolled asphalt surface course with 10 mm aggregate 25mm thick with surface dressing - Surfaces sloping at 10° or less to the horizontal	m ²	1550	_____ / _____	_____ / _____		€31.00	€48,050.00	

Dodder Public Transportation Opening Bridge							Cost Estimate		
Bill Part 2: Eastern & Western Approach Roads							Rate	Amount €	Totals €
Bill Part/ Constr Heading/ Series	Item No.	Item Description	Unit	Quantity	Rate	Amount €	Totals €		
		TOTAL CARRIED FORWARD TO Construction Heading 1 SUMMARY					_____/____		€56,002.50
2/1/1200		Series 1200: Traffic Signs and Road Markings							
2/1/1200		Traffic Signs							
2/1/1200		Permanent traffic signs - Retroreflective - Lit Sign Units - Face exceeding 0.50 square metre but not exceeding 0.75 square metre in area - On one tubular steel post	no	20	_____/____	_____/____		€275.00	€5,500.00
2/1/1200		Road Markings							
2/1/1200		Road markings - Continuous lines - Thermoplastic screed with applied solid glass beads - 100mm wide - TSRGD Diag No. 1013.1 - White in colour	m	66	_____/____	_____/____		€2.20	€145.20
2/1/1200		Road markings - Intermittent lines - Thermoplastic screed with applied solid glass beads - 100mm wide - 600mm mark length, 300mm gap length - TSRGD Dia No. 1009A - White in colour	m	161	_____/____	_____/____		€4.15	€668.15
2/1/1200		Road markings - Intermittent lines - Thermoplastic screed with applied solid glass beads - 200mm wide - 1000mm mark length, 1000mm gap length - TSRGD Diag no. 1003.1 - White in colour	m	95	_____/____	_____/____		€4.15	€394.25
2/1/1200		Road markings - Ancillary lines - Thermoplastic screed with applied solid glass beads - 150mm wide - In hatched areas - White in colour	m	182	_____/____	_____/____		€3.05	€555.10
2/1/1200		Road markings - Triangles - Thermoplastic screed with applied solid glass beads - TSRGD Diag No. 1023A - White in colour	no	1	_____/____	_____/____		€60.00	€60.00
2/1/1200		Road markings - Arrows - Thermoplastic screed with applied solid glass beads - 6.00m long - Straight, to TSRGD Diag No. 1038 - White in colour	no	6	_____/____	_____/____		€72.00	€432.00
2/1/1200		Road markings - Symbols - Thermoplastic screed with applied solid glass beads - 1600mm high - BICYCLE - White in colour	no	1	_____/____	_____/____		€71.00	€71.00
		TOTAL CARRIED FORWARD TO Construction Heading 1 SUMMARY					_____/____		€7,825.70
2/1/1300		Series 1300: Road Lighting Columns and Brackets							
2/1/1300		Road Lighting Columns, Brackets and Wall Mountings							
2/1/1300		Road lighting columns and brackets - 10m height - Steel road lighting column, planted base - Single bracket arm with a luminaire unit	no	20	_____/____	_____/____		€1,642.50	€32,850.00
		TOTAL CARRIED FORWARD TO Construction Heading 1 SUMMARY					_____/____		€32,850.00
2/1/1400		Series 1400: Electrical Works for Road Lighting and Traffic Signs							
2/1/1400		Cabling							
2/1/1400		Cabling and electrics - Steel road lighting columns	m	200	_____/____	_____/____		€10.75	€2,150.00
2/1/1400		Cable Joints and Cable Terminations							
2/1/1400		Cable termination - To road lighting columns, feeder pillars and subway lighting - 3mm x 2.5mm Cables	no	20	_____/____	_____/____		€30.50	€610.00
2/1/1400		Feeder Pillars							
2/1/1400		Galvanised steel feeder pillar including marine plywood baseboard and all internal electrical equipment, standard - Supplied by Transport Infrastructure Ireland	no	20	_____/____	_____/____		€1,100.00	€22,000.00
2/1/1400		Earth Electrodes							
2/1/1400		Galvanised steel or copper earth electrodes, 1.2m long, 22mm diameter within feeder pillar base, or in separate enclosure	no	20	_____/____	_____/____		€57.50	€1,150.00
		TOTAL CARRIED FORWARD TO Construction Heading 1 SUMMARY					_____/____		€25,910.00
2/1/1700		Series 1700: Structural Concrete							
2/1/1700		In Situ Concrete							
2/1/1700		In situ concrete - Provision for architectural retaining walls at Ringsend side	m	55.5	_____/____	_____/____		€3,750.00	€208,125.00
		TOTAL CARRIED FORWARD TO Construction Heading 1 SUMMARY					_____/____		€208,125.00
2/1/3000		Series 3000: Landscape and Ecology							
2/1/3000		Landscaping/ Fittings							
2/1/3000		Landscaping, planting and furnishings provision	item	1	_____/____	_____/____		€1,000,000.00	€1,000,000.00
		TOTAL CARRIED FORWARD TO Construction Heading 1 SUMMARY					_____/____		€1,000,000.00

Dodder Public Transportation Opening Bridge										
Bill Part 2: Eastern & Western Approach Roads										
Bill Part/ Constr Heading/ Series	Item No.	Item Description	Unit	Quantity	Rate	Amount €	Totals €	Cost Estimate		
								Rate	Amount €	Totals €
		Construction Heading 1: Eastern Approach Road - Summary								
2/1/200		Series 200: Site Clearance					_____ / _____			€1,481.85
2/1/300		Series 300: Fencing and Environmental Noise Barriers					_____ / _____			€5,000.00
2/1/400		Series 400: Road Restraint Systems (Vehicle and Pedestrian)					_____ / _____			€275,810.00
2/1/500		Series 500: Drainage and Service Ducts					_____ / _____			€43,187.51
2/1/600		Series 600: Earthworks					_____ / _____			€17,451.45
2/1/700		Series 700: Pavements					_____ / _____			€122,211.70
2/1/1100		Series 1100: Kerbs, Footways and Paved Areas					_____ / _____			€56,002.50
2/1/1200		Series 1200: Traffic Signs and Road Markings					_____ / _____			€7,825.70
2/1/1300		Series 1300: Road Lighting Columns and Brackets					_____ / _____			€32,850.00
2/1/1400		Series 1400: Electrical Works for Road Lighting and Traffic Signs					_____ / _____			€25,910.00
2/1/1700		Series 1700: Structural Concrete					_____ / _____			€208,125.00
2/1/3000		Series 3000: Landscape and Ecology					_____ / _____			€1,000,000.00
		TOTAL CARRIED FORWARD TO Bill Part 2 SUMMARY					_____ / _____			€1,795,855.71

Dodder Public Transportation Opening Bridge							Cost Estimate		
Bill Part 2: Eastern & Western Approach Roads							Rate	Amount €	Totals €
Bill Part/ Constr Heading/ Series	Item No.	Item Description	Unit	Quantity	Rate	Amount €	Totals €		
Construction Heading 2: Western Approach Road									
Series 400: Road Restraint Systems (Vehicle and Pedestrian)									
2/2/400		Safety Barriers							
2/2/400		Safety barrier; standard socketed post foundation - Type N2W2 - Designed to be impacted on one side only - Straight or curved exceeding 120 metres radius	m	38	_____ / _____	_____ / _____		€255.00	€9,690.00
2/2/400		Transitions							
2/2/400		Transitions between safety barriers and parapets - From single sided N2W2 to bridge parapet - Designed to be impacted on one side only - Straight or curved exceeding 120 metres radius	no	2	_____ / _____	_____ / _____		€1,800.00	€3,600.00
2/2/400		Terminals							
2/2/400		Terminal; Single Sided Flex Beam - P1 - Designed to be impacted on one side only	no	2	_____ / _____	_____ / _____		€925.00	€1,850.00
2/2/400		Pedestrian Parapets, Pedestrian Guardrails and Handrails							
2/2/400		Pedestrian Guardrails as shown on the drawings - 1000mm high	m	38	_____ / _____	_____ / _____		€3,500.00	€133,000.00
2/2/400		TOTAL CARRIED FORWARD TO Construction Heading 2 SUMMARY					_____ / _____		€148,140.00
Series 500: Drainage and Service Ducts									
Drains, Sewers, Piped Culverts and Service Ducts (Excluding Filter Drains, Narrow Filter Drains & Fin Drains)									
2/2/500		Drains or sewers - 450mm diameter - Depth to invert not exceeding 2m; Average depth <2.0m - uPVC drain - Bed Type S in trench	m	84	_____ / _____	_____ / _____		€158.15	€13,284.56
2/2/500		Chambers and Gullies							
2/2/500		Chambers - Precast concrete chamber 1500mm diameter - Depth to invert exceeding 1 metre but not exceeding 2 metres - D400 cover and frame	no	2	_____ / _____	_____ / _____		€597.00	€1,194.00
2/2/500		Gullies - Precast concrete trapped gully - D400 hinged cover and frame	no	6	_____ / _____	_____ / _____		€975.00	€5,850.00
2/2/500		TOTAL CARRIED FORWARD TO Construction Heading 2 SUMMARY					_____ / _____		€20,328.56
Series 600: Earthworks									
Breaking up and Perforation of Redundant Pavements									
2/2/600		Breaking up of redundant pavements - Type, Existing paved areas and part of road - Depth exceeding 100mm but not exceeding 200mm	m ²	760	_____ / _____	_____ / _____		€19.02	€14,456.42
2/2/600		TOTAL CARRIED FORWARD TO Construction Heading 2 SUMMARY					_____ / _____		€14,456.42
Series 700: Pavements									
Sub-base									
2/2/700		Capping layer sub-base, 300mm deep - In carriageway	m ³	85	_____ / _____	_____ / _____		€235.50	€20,017.50
2/2/700		Granular Type 1 sub-base, 300mm deep - In carriageway	m ³	85	_____ / _____	_____ / _____		€235.50	€20,017.50
Pavement									
2/2/700		Pavement - Base course - Dense bitumen macadam 150mm thick with 28mm aggregate - In Western approach road carriageway	m ²	270	_____ / _____	_____ / _____		€35.00	€9,450.00
2/2/700		Pavement - Binder course - Dense macadam 60mm thick with 20mm aggregate - In Western approach road carriageway	m ²	270	_____ / _____	_____ / _____		€26.00	€7,020.00
2/2/700		Pavement - Surface course - Hot rolled asphalt 40mm thick with 10mm aggregate - In Western approach road carriageway	m ²	270	_____ / _____	_____ / _____		€14.50	€3,915.00
2/2/700		Surface Treatment							
2/2/700		Surface Dressing - Resin based surface treatment to cycleways - Colour TBC	m ²	495	_____ / _____	_____ / _____		€25.96	€12,850.20
2/2/700		TOTAL CARRIED FORWARD TO Construction Heading 2 SUMMARY					_____ / _____		€73,270.20
Series 1100: Kerbs, Footways and Paved Areas									
Kerbs, Channels, Edgings, Combined Drainage and Kerb Blocks and Linear Drainage Channel Systems									
2/2/1100		Kerbs - Precast concrete kerb - Straight or curved exceeding 12 metres radius	m	40	_____ / _____	_____ / _____		€25.00	€1,000.00
2/2/1100		Footways and Paved Areas							
2/2/1100		Footways - Footpath/ cycletrack; granular material Type 1 sub-base 150 thick, dense macadam binder course with 14 mm aggregate 40 thick, rolled asphalt surface course with 10 mm aggregate 25mm thick with surface dressing - Surfaces sloping at 10° or less to the horizontal	m ²	495	_____ / _____	_____ / _____		€31.00	€15,345.00
2/2/1100		TOTAL CARRIED FORWARD TO Construction Heading 2 SUMMARY					_____ / _____		€16,345.00
Series 1200: Traffic Signs and Road Markings									
Traffic Signs									
2/2/1200		Permanent traffic signs - Retroreflective - Lit Sign Units - Face exceeding 0.50 square metre but not exceeding 0.75 square metre in area - On one tubular steel post	no	6	_____ / _____	_____ / _____		€275.00	€1,650.00
2/2/1200		Road Markings							
2/2/1200		Road markings - Intermittent lines - Thermoplastic screed with applied solid glass beads - 100mm wide - 600mm mark length, 300mm gap length - TSRGD Dia No. 1009A - White in colour	m	20	_____ / _____	_____ / _____		€4.15	€83.00
2/2/1200		Road markings - Intermittent lines - Thermoplastic screed with applied solid glass beads - 200mm wide - 1000mm mark length, 1000mm gap length - TSRGD Diag no. 1003.1 - White in colour	m	45	_____ / _____	_____ / _____		€4.15	€186.75
2/2/1200		Road markings - Symbols - Thermoplastic screed with applied solid glass beads - 1600mm high - BICYCLE - White in colour	no	2	_____ / _____	_____ / _____		€71.00	€142.00
2/2/1200		TOTAL CARRIED FORWARD TO Construction Heading 2 SUMMARY					_____ / _____		€2,061.75
Series 1300: Road Lighting Columns and Brackets									
Road Lighting Columns, Brackets and Wall Mountings									
2/2/1300		Road lighting columns and brackets - 10m height - Steel road lighting column, planted base - Single bracket arm with a luminaire unit	no	6	_____ / _____	_____ / _____		€1,642.50	€9,855.00
2/2/1300		TOTAL CARRIED FORWARD TO Construction Heading 2 SUMMARY					_____ / _____		€9,855.00
Series 1400: Electrical Works for Road Lighting and Traffic Signs									
Cabling									
2/2/1400		Cabling and electrics - Steel road lighting columns	m	50	_____ / _____	_____ / _____		€10.75	€537.50
Cable Joints and Cable Terminations									
2/2/1400		Cable termination - To road lighting columns, feeder pillars and subway lighting - 3mm x 2.5mm Cables	no	6	_____ / _____	_____ / _____		€30.50	€183.00

Dodder Public Transportation Opening Bridge										
Bill Part 2: Eastern & Western Approach Roads										
Bill Part/ Constr Heading/ Series	Item No.	Item Description	Unit	Quantity	Rate	Amount €	Totals €	Cost Estimate		
								Rate	Amount €	Totals €
2/2/1400		Feeder Pillars								
2/2/1400		Galvanised steel feeder pillar including marine plywood baseboard and all internal electrical equipment, standard - Supplied by Transport Infrastructure Ireland	no	6	_____ / _____	_____ / _____		€1,100.00	€6,600.00	
2/2/1400		Earth Electrodes								
2/2/1400		Galvanised steel or copper earth electrodes, 1.2m long, 22mm diameter within feeder pillar base, or in separate enclosure	no	6	_____ / _____	_____ / _____		€57.50	€345.00	
		TOTAL CARRIED FORWARD TO Construction Heading 2 SUMMARY					_____ / _____			€7,665.50

Dodder Public Transportation Opening Bridge										
Bill Part 2: Eastern & Western Approach Roads										
Bill Part/ Constr Heading/ Series	Item No.	Item Description	Unit	Quantity	Rate	Amount €	Totals €	Cost Estimate		
								Rate	Amount €	Totals €
		Construction Heading 2: Western Approach Road - Summary								
2/2/400		Series 400: Road Restraint Systems (Vehicle and Pedestrian)					_____ / _____			€148,140.00
2/2/500		Series 500: Drainage and Service Ducts					_____ / _____			€20,328.56
2/2/600		Series 600: Earthworks					_____ / _____			€14,456.42
2/2/700		Series 700: Pavements					_____ / _____			€73,270.20
2/2/1100		Series 1100: Kerbs, Footways and Paved Areas					_____ / _____			€16,345.00
2/2/1200		Series 1200: Traffic Signs and Road Markings					_____ / _____			€2,061.75
2/2/1300		Series 1300: Road Lighting Columns and Brackets					_____ / _____			€9,855.00
2/2/1400		Series 1400: Electrical Works for Road Lighting and Traffic Signs					_____ / _____			€7,665.50
		TOTAL CARRIED FORWARD TO Bill Part 2 SUMMARY					_____ / _____			€292,122.42

Dodder Public Transportation Opening Bridge										
Bill Part 2: Eastern & Western Approach Roads										
Bill Part/ Constr Heading/ Series	Item No.	Item Description	Unit	Quantity	Rate	Amount €	Totals €	Cost Estimate		
								Rate	Amount €	Totals €
		Bill Part 2: Eastern & Western Approach Roads - Summary								
		Construction Heading 1: Eastern Approach Road					_____ / ____			€1,795,855.71
		Construction Heading 2: Western Approach Road					_____ / ____			€292,122.42
		Total Carried Forward to General Summary					_____ / ____			€2,087,978.13

Dodder Public Transportation Opening Bridge								Cost Estimate		
Bill Part 3: Land Reclamation								Rate	Amount €	Totals €
Bill Part/ Constr Heading/ Series	Item No.	Item Description	Unit	Quantity	Rate	Amount €	Totals €	Rate	Amount €	Totals €
Construction Heading 1: Main										
Series 100: Preliminaries										
Special Preliminaries - General										
3/1/100	3/1/100	Temporary protection to Liffey service tunnel southern shaft and to Liffey service tunnels	item	1	_____ / _____	_____ / _____		€50,000.00	€50,000.00	
3/1/100	3/1/100	Temporary protection to GNI high pressure gas mains	item	1	_____ / _____	_____ / _____		€50,000.00	€50,000.00	
TOTAL CARRIED FORWARD TO Construction Heading 1 SUMMARY										€100,000.00
Series 200: Site Clearance										
Take Up or Down and Set Aside for Reuse or Remove to Store or Tip off Site										
3/1/200	3/1/200	Take up or down and remove to tip off site - Rock armour	m ²	0	_____ / _____	_____ / _____		€63.00	€0.00	
TOTAL CARRIED FORWARD TO Construction Heading 1 SUMMARY										€0.00
Series 400: Road Restraint Systems (Vehicle and Pedestrian)										
Safety Barriers										
3/1/400	3/1/400	Safety barrier; pedestrain railing to edge of reclaimed land - Straight or curved exceeding 120 metres radius	m	235	_____ / _____	_____ / _____		€372.07	€87,435.46	
TOTAL CARRIED FORWARD TO Construction Heading 1 SUMMARY										€87,435.46
Series 600: Earthworks										
Imported Fill										
3/1/600	3/1/600	Imported acceptable material fill - Fill above structural concrete foundations	m ³	15590	_____ / _____	_____ / _____		€16.00	€249,440.00	
3/1/600	3/1/600	Compaction of Fill	m ³	15590	_____ / _____	_____ / _____		€4.50	€70,155.00	
3/1/600	3/1/600	Completion of Formation and Sub-Formation	m ²	3900	_____ / _____	_____ / _____		€84.00	€327,600.00	
TOTAL CARRIED FORWARD TO Construction Heading 1 SUMMARY										€647,195.00
Series 1600: Piling and Embedded Retaining Walls										
Piling Plant										
3/1/1600	3/1/1600	Establishment of piling plant - Bored cast-in-place piles - 800mm Diameter - Preliminary piling as a separate operation in advance of the main piling	no	1	_____ / _____	_____ / _____		€16,497.75	€16,497.75	
3/1/1600	3/1/1600	Establishment of piling plant - Bored cast-in-place piles - 800mm diameter - Main piling	no	1	_____ / _____	_____ / _____		€16,497.75	€16,497.75	
3/1/1600	3/1/1600	Establishment of piling plant - Steel sheet piles - Main piling	no	1	_____ / _____	_____ / _____		€10,521.32	€10,521.32	
3/1/1600	3/1/1600	Moving piling plant - Bored cast-in-place piles - 800mm Diameter - Preliminary piling as a separate operation in advance of the main piling	no	1	_____ / _____	_____ / _____		€202.38	€202.38	
3/1/1600	3/1/1600	Moving piling plant - Bored cast-in-place piles - 800mm diameter - Main piling	no	96	_____ / _____	_____ / _____		€202.38	€19,428.65	
Cast-in-place Piles										
3/1/1600	3/1/1600	Pile shafts - Vertical - Reinforced concrete piles - 800mm diameter - Pile shafts exceeding 20 metres in length but not exceeding 25 metres - Preliminary piling as a separate operation in advance of the main piling	m	21.5	_____ / _____	_____ / _____		€378.49	€8,137.48	
3/1/1600	3/1/1600	Pile shafts - Vertical - Reinforced concrete piles - 800mm diameter - Pile shafts exceeding 20 metres in length but not exceeding 25 metres - Main piling	m	2064	_____ / _____	_____ / _____		€378.49	€781,197.91	
Reinforcement for Cast-in-place Piles										
3/1/1600	3/1/1600	Bar reinforcement - Nominal size 20 millimetres and over - Grade B500B - Bars not exceeding 12 metres in length	t	41.2	_____ / _____	_____ / _____		€1,225.00	€50,470.00	
3/1/1600	3/1/1600	Bar reinforcement - Nominal size 16 millimetres and under - Grade B500B - Bars not exceeding 12 metres in length	t	123.5	_____ / _____	_____ / _____		€1,225.00	€151,287.50	
Steel Sheet Piles										
3/1/1600	3/1/1600	Steel sheet piles - Piles exceeding 25 metres in length but not exceeding 30 metres - In main construction	m ²	5440	_____ / _____	_____ / _____		€184.35	€1,002,848.90	
3/1/1600	3/1/1600	Driving - Piles exceeding 25 metres in length but not exceeding 30 metres - In main construction	m ²	5440	_____ / _____	_____ / _____		€61.01	€331,880.66	
3/1/1600	3/1/1600	Cutting or boring off surplus - In main construction	m	253	_____ / _____	_____ / _____		€250.99	€63,499.94	
King Post Walling										
3/1/1600	3/1/1600	King post walling - To span services	m ²	310	_____ / _____	_____ / _____		€245.35	€76,059.96	
Proof Loading of Piles										
3/1/1600	3/1/1600	Establishment of proof loading equipment - 800mm diameter bored cast-in-place piles - Preliminary piles - Maintained load - Vertical	item	1	_____ / _____	_____ / _____		€4,500.00	€4,500.00	
3/1/1600	3/1/1600	Establishment of Integrity testing equipment - 800mm diameter bored cast-in-place piles - Preliminary piles - Sonic Echo testing - Vertical	item	1	_____ / _____	_____ / _____		€600.00	€600.00	
3/1/1600	3/1/1600	Establishment of Integrity testing equipment - 800mm diameter bored cast-in-place piles - Main piles - Sonic Echo testing - Vertical	item	1	_____ / _____	_____ / _____		€600.00	€600.00	
3/1/1600	3/1/1600	Proof loading piles - 800mm diameter bored cast-in-place piles - Preliminary piles - Maintained load - Vertical	no	1	_____ / _____	_____ / _____		€14,812.50	€14,812.50	
3/1/1600	3/1/1600	Integrity testing of piles - Sonic Echo Testing - 800mm diameter bored cast-in-place piles - Preliminary piles	no	1	_____ / _____	_____ / _____		€22.50	€22.50	
3/1/1600	3/1/1600	Integrity testing of piles - Sonic Echo Testing - 800mm diameter bored cast-in-place piles - Main piles	no	96	_____ / _____	_____ / _____		€22.50	€2,160.00	
TOTAL CARRIED FORWARD TO Construction Heading 1 SUMMARY										€2,551,225.18
Series 1700: Structural Concrete										
In Situ Concrete										
3/1/1700	3/1/1700	In situ concrete - Mix II Skeletal Abutment Piers	m ³	1950	_____ / _____	_____ / _____		€137.50	€268,125.00	
3/1/1700	3/1/1700	In situ concrete - Mix III Deck Slabs, Wingwalls, Abutments, Exposed Piers, Precast Parapets, Restraining Slabs, Plinths/ Concrete Upstands, Boundary Walls	m ³	205	_____ / _____	_____ / _____		€135.00	€27,675.00	
3/1/1700	3/1/1700	In situ concrete - Mix ST1 - Blinding Concrete 75mm or less in thickness	m ³	295	_____ / _____	_____ / _____		€82.50	€24,337.50	
Surface Finish of Concrete - Formwork										
3/1/1700	3/1/1700	Formwork - Vertical more than 300mm wide - F1 finish	m ²	205	_____ / _____	_____ / _____		€47.50	€9,737.50	
3/1/1700	3/1/1700	Formwork - Horizontal less than 300mm wide - F1 finish	m ²	200	_____ / _____	_____ / _____		€47.50	€9,500.00	
3/1/1700	3/1/1700	Formwork - Curved of both girth and width more than 300mm at any inclination - F1 finish	m ²	10	_____ / _____	_____ / _____		€135.00	€1,350.00	
Steel Reinforcement for Structures										
3/1/1700	3/1/1700	Bar reinforcement - Nominal size 16 millimetres and under - Grade B500B - Bars not exceeding 12 metres in length	t	84.6	_____ / _____	_____ / _____		€1,225.00	€103,635.00	
3/1/1700	3/1/1700	Bar reinforcement - Nominal size 20 millimetres and over - Grade B500B - Bars not exceeding 12 metres in length	t	253.8	_____ / _____	_____ / _____		€1,225.00	€310,905.00	
TOTAL CARRIED FORWARD TO Construction Heading 1 SUMMARY										€755,265.00

Dodder Public Transportation Opening Bridge										
Bill Part 3: Land Reclamation										
Bill Part/ Constr Heading/ Series	Item No.	Item Description	Unit	Quantity	Rate	Amount €	Totals €	Cost Estimate		
								Rate	Amount €	Totals €
3/1/2000		Series 2000: Waterproofing for Structures								
3/1/2000		Waterproofing								
3/1/2000		Waterproofing - Epoxy resin MCDUR 1680 or similar approved - More than 300mm wide horizontal or at any inclination up to and including 30° to the horizontal	m ²	4115	_____ / _____	_____ / _____		€13.50	€55,552.50	
3/1/2000		Waterproofing - Epoxy resin MCDUR 1680 or similar approved - More than 300mm wide at any inclination more than 30° up to and including 90° to the horizontal	m ²	175	_____ / _____	_____ / _____		€13.50	€2,362.50	
3/1/2000		Surface Impregnation and Coatings of Concrete								
3/1/2000		Surface impregnation and coatings of concrete - Plain surfaces - Surface impregnation including anti-graffiti protection coating, Silane in accordance with Appendix 17/2 to exposed concrete faces	m ²	470	_____ / _____	_____ / _____		€15.00	€7,050.00	
		TOTAL CARRIED FORWARD TO Construction Heading 1 SUMMARY					_____ / _____			€64,965.00
3/1/2300		Series 2300: Bridge Expansion Joints and Sealing of Gaps								
3/1/2300		Sealing of Gaps								
3/1/2300		Joint sealant - Polysulphide sealant between main sheet pile wall and slipway ramp - 25mm thick	m	50	_____ / _____	_____ / _____		€31.25	€1,562.50	
		TOTAL CARRIED FORWARD TO Construction Heading 1 SUMMARY					_____ / _____			€1,562.50

Dodder Public Transportation Opening Bridge										
Bill Part 3: Land Reclamation										
Bill Part/ Constr Heading/ Series	Item No.	Item Description	Unit	Quantity	Rate	Amount €	Totals €	Cost Estimate		
								Rate	Amount €	Totals €
		Construction Heading 1: Main - Summary								
3/1/100		Series 100: Preliminaries					_____ / _____			€100,000.00
3/1/200		Series 200: Site Clearance					_____ / _____			€0.00
3/1/400		Series 400: Road Restraint Systems (Vehicle and Pedestrian)					_____ / _____			€87,435.46
3/1/600		Series 600: Earthworks					_____ / _____			€647,195.00
3/1/1600		Series 1600: Piling and Embedded Retaining Walls					_____ / _____			€2,551,225.18
3/1/1700		Series 1700: Structural Concrete					_____ / _____			€755,265.00
3/1/2000		Series 2000: Waterproofing for Structures					_____ / _____			€64,965.00
3/1/2300		Series 2300: Bridge Expansion Joints and Sealing of Gaps					_____ / _____			€1,562.50
		TOTAL CARRIED FORWARD TO Bill Part 3 SUMMARY					_____ / _____			€4,207,648.15

Dodder Public Transportation Opening Bridge								Cost Estimate		
Bill Part 3: Land Reclamation								Rate	Amount €	Totals €
Bill Part/ Constr Heading/ Series	Item No.	Item Description	Unit	Quantity	Rate	Amount €	Totals €			
		Bill Part 3: Land Reclamation - Summary								
		Construction Heading 1: Main					_____ / _____			€4,207,648.15
		Total Carried Forward to General Summary					_____ / _____			€4,207,648.15

APPENDIX 7.2 PRICING DOCUMENT BUILDING WORKS



NOLAN
construction
consultants

PROPOSED ST. PATRICKS ROWING CLUB

at

RINGSEND, DUBLIN

for

DUBLIN CITY COUNCIL

DRAFT

**PRELIMINARY DESIGN
STAGE COST ESTIMATE NR. 1**

31st AUGUST 2020



*Nolan Construction Consultants
Chartered Quantity Surveyors
9 Wallace House, Canada Street
Waterford X91 PP2R
(051) 841719*





PRELIMINARY DESIGN STAGE COST ESTIMATE NR. 1

BREAKDOWN OF ESTIMATED COSTS

1. Based on preliminary architectural drawings received from Sean Harrington Architects and information received from Roughan & O'Donovan Engineers, we estimate the construction cost of the proposal to be as set out below (excluding VAT):

Construction Costs	€	€/m2
1.1 Main Building Works	1,097,000	2,146.77
1.2 Mechanical, Electrical & Lift Installations	196,000	383.56
1.3 Preliminaries & Insurances	155,000	303.33
1.4 Design Contingency	72,000	140.90
TOTAL ESTIMATED COST (EXCLUDING VAT)	€ 1,520,000	2,974.56

BASIS OF ESTIMATE

2. The estimated costs are based on the following:
- 2.1 competitive tenders being obtained
 - 2.2 fire and DAC requirements are reasonable
3. The project is at a very preliminary stage and the cost estimate includes for what are considered to be reasonable provisions in respect of the structural requirements for the building. These will have to be reviewed as the design progresses & our budget revised accordingly.
4. We have included amounts for mechanical, electrical and lift installations. However, the scope and specification would need to be detailed and the figures confirmed by a Services Specialist.
5. Allowances have been made for the following items which would need to be reviewed and our estimate adjusted once specifications are confirmed:
- 5.1 roller doors to store rooms
 - 5.2 fitted kitchen and curved office desk
 - 5.3 canopy
 - 5.4 terrace structure and finishes



EXCLUSIONS

6. The following items are **excluded** from the estimated costs:
 - 6.1 land acquisition costs
 - 6.2 professional fees and expenses
 - 6.3 flat slab and associated pile support
 - 6.4 specific features (sculptures)
 - 6.5 all siteworks
 - 6.6 loose furniture & fittings (lockers, computers, office equipment etc.)
 - 6.7 bar counter to function room
 - 6.8 site investigation / archaeology / surveys
 - 6.9 contributions to public utilities
 - 6.10 Dublin County Council costs (administration, planning, clerk of works, etc.)
 - 6.11 inflation from August 2020
 - 6.12 value added tax

APPENDICES

7. The following appendices are included in this estimate:
 - 7.1 Appendix 1 - Elemental breakdown of estimated construction costs
 - 7.2 Appendix 2 - Drawings & documents used in the preparation of this estimate

Paul F. Nolan FSCSI FRICS

Director

NOLAN CONSTRUCTION CONSULTANTS

31st August 2020



APPENDIX 1

ELEMENTAL BREAKDOWN OF ESTIMATED CONSTRUCTION COSTS



APPENDIX 1 - ELEMENTAL BREAKDOWN OF ESTIMATED CONSTRUCTION COSTS

Ele. No.	Element	Total €	Cost/m2 511 m2	Brief Specification
Building Works				
(19)	Substructure	68,000	133.07	Rising walls; underfloor drainage; hardcore filling; insulation; concrete floor slab; reinforcement mesh; powerfloating; floor joints; lift pit
(21)	External Walls	152,000	297.46	465mm insulated cavity wall consisting of 215mm block inner leaf, brick outer leaf, 150mm full fill insulation; tying blockwork to steel columns; 315mm masonry wall to external stairs consisting of 215mm block inner leaf; brick outer leaf; allowance for firestopping
(22)	Internal Walls	53,000	103.72	215mm concrete walls to lift shaft and internal stair core; 100, 140 and 215mm blockwork; 465mm insulated cavity wall consisting of one leaf 215mm blockwork, one leaf 100mm blockwork, 150mm full fill insulation; bonding blockwork to concrete walls
(23)	Floors, Galleries	99,000	193.74	First floor consisting of 550mm deep steelwork framing members; 200mm deep hollowcore concrete floor slab; 75mm screed with A142 mesh; Terrace consisting of cantilever beams; precast concrete slab; proprietary structural thermal break system
(24)	Stairs	13,000	25.44	Allowance for 2nr precast concrete stairs
(27)	Roofs	58,000	113.50	Structural steel trusses; steelwork rafters propped at ridge level to function room; bracing; purlins
(28)	Frame	74,000	144.81	Structural steel columns and beams
(31)	External Walls: Completions	135,000	264.19	Curved curtain walling to west elevation, triple glazed timber alu-clad windows; external doors, allowance for roller doors to store rooms; ironmongery; air tightness; allowance for canopy including steel support
(32)	Internal Walls: Completions	20,000	39.14	Fire rated doors and frames; ironmongery
	(b/f)	672,000	1,315.07	
(W0769)			- A1/2 -	



Ele. No.	Element	Total €	Cost/m2 511m2	Brief Specification
	(c/f)	672,000	1,315.07	
(33)	Floors Completions	26,000	50.88	1125mm high marine grade stainless steel balustrade and handrail to external terrace; floor grilles & openings to riser shaft
(34)	Stairs Completions	12,000	23.48	1125mm high marine grade stainless steel balustrade and handrail to external stairs; balustrade and handrail to internal stairwell
(41)	Wall Finishes Externally	16,000	31.31	Render and paint to isolated areas; stone string courses
(42)	Wall Finishes Internally	52,000	101.76	Render to store rooms; plaster and paint to circulation areas, kitchen, offices, gym and function room; wall tiling to toilet, shower rooms, changing rooms and above fitted kitchen
(43) & (44)	Floor Finishes; Stairs, Ramps Finishes	58,000	113.50	Timber sprung floor, timber skirting to gym and function room; vinyl flooring, timber skirting to circulation areas, offices, kitchen and internal stairs; tiling to toilet, shower rooms and changing rooms; sealer to exposed concrete floor to store rooms and external stairs; allowance for floor finish to terrace; tanking to terrace; nosings to stairs
(45)	Ceiling Finishes	69,000	135.03	Suspended grid type system to circulation areas; suspended MF type system, plaster and paint finish to toilets, offices, gym and vaulted function room; allowance for weathered ceiling finish to stores; insulation to store ceilings and single storey ceiling under terrace; access panels
(47)	Roof Finishes	156,000	305.28	Pre-patinated copper standing seam roof, flashings, fascia and soffit; insulation; plywood decking; tegral demountable suspended ceiling to terrace soffit
(52)	Drainage & Refuse Disposal	8,000	15.66	Allowance for rainwater disposal; pre-patinated copper gutters and outlets; aluminium downpipes; proprietary outlets at terrace
(59)	Mechanical Installations	85,000	166.34	Allowance for Mechanical installations; builders work
	(b/f)	<u>1,154,000</u>	<u>2,258.32</u>	



Ele. No.	Element	Total €	Cost/m2 511m2	Brief Specification
	(c/f)	1,154,000	2,258.32	
(66)	Lift Installations	40,000	78.28	Allowance for Lift installations; builders work
(69)	Electrical Installations	71,000	138.94	Allowance for Electrical installations; builders work
(74)	Sanitary Fittings	13,000	25.44	Accessible WCs; WHB's; WC's; showers; mirrors; grabrails; accessories
(79)	Fittings Generally	15,000	29.35	Allowance made for fitted kitchen, fixed benching to changing rooms; curved fitted office desk
		<hr/>	<hr/>	
		1,293,000	2,530.33	
Preliminaries and Insurances				
(06) & (07)	Preliminaries & Insurances	155,000	303.33	Contractor's indirect costs, supervision, plant; health and safety; insurances; performance bond ,etc.
(08)	Contingencies	72,000	140.90	Allowance for design development
<hr/>				
Total Estimated Cost (Excl VAT) €		1,520,000	2,974.56	



APPENDIX 2

DRAWINGS & DOCUMENTS USED IN THE PREPARATION OF THIS ESTIMATE



APPENDIX 1 - DRAWINGS & DOCUMENTS USED IN THE PREPARATION OF THIS ESTIMATE

SHA DRAWINGS

The following SHA drawings were used in the preparation of this estimate:

SK/1/RevC	Proposed Ground Floor Plan
SK/2/RevA	Proposed Upper Floor Plan
SK/08RevA	Proposed Elevations / Sections
SK/09C	Site Plan
SK/11	3D 1
SK/12	3D 2
SK20	Sketch Drawings
SK-26	3-D Images

ROD DOCUMENTS

The following ROD document was used in the preparation of this estimate:

DPTB-ROD-C1-SWE-RPT-CV-00026-01 St. Patrick's Rowing Club / Dublin City Council
Building Structural Concept

APPENDIX 8 ST PATRICK'S ROWING CLUB FEASIBILITY REPORT

DODDER PUBLIC TRANSPORTATION OPENING BRIDGE



St Patrick's Rowing Club Feasibility Report | June 2022
DPTB-ROD-C1-SWE-RPT-PM-00029-04



PROJECT SPONSORING AGENCY



Comhairle Cathrach
Bhaile Átha Cliath
Dublin City Council

PROJECT SANCTIONING AUTHORITY



Údarás
Náisiúnta Iompair
National **Transport** Authority

Dodder Public Transportation Opening Bridge

St Patrick's Rowing Club Feasibility Report

Document No: DPTB-ROD-C1-SWE-RPT-PM-00029

Author:..... Rachel Harney

Checker: Joe Kelly

Approver:..... Tony Dempsey

Document No	Revision	Description	Made	Checked	Approved	Date
DPTB-ROD-C1-SWE-RPT-PM-00029	04	SPRC Feasibility Report	RH	JK	TD	23/06/2022

Dodder Public Transportation Opening Bridge

St Patrick's Rowing Club Feasibility Report

TABLE OF CONTENTS

1.0	Consultations & Constraints	3
1.1.	St Patrick's Rowing Club.....	3
1.2.	Kennedy Wilson.....	4
1.3.	Land Availability.....	5
2.	CONCLUSIONS AND RECOMMENDATIONS	5
2.1.	St Patrick's Rowing Club.....	5
2.2.	Control Building.....	8

1. CONSULTATIONS AND CONSTRAINTS

Construction of any structure requires careful consideration of the constraints and impacts on the existing infrastructure in the locality as well as the anticipated construction impacts to ensure that risks that may arise from the preferred design are either eliminated or where this is not possible, they are mitigated to reasonably practicable levels so they can be effectively managed. This report provides a summary of the key elements of the decision-making process to inform the feasibility or otherwise for the proposed permanent location of the St Patricks Rowing Club as well as the required Control Room for the new opening bridge.

The main objectives of the Project that relate to the St Patricks Rowing Club and Control Room in line with the over-riding purpose for this project are to: -

- Provide St. Patrick's Rowing Club building and facilities which are; architecturally sensitive with the surrounding site constraints; in an optimum location; complementary with the adjacent surroundings including the Samuel Beckett Bridge, Capital Dock, Grand Canal Dock, local residential apartment complexes and houses, Quay Walls, Tom Clarke Bridge and a possible new pedestrian/cycling bridge over the Liffey.
- Provide a control building for the operation of the proposed Dodder Bridge which may also be used to operate the Tom Clarke Bridge, and future opening bridges in the vicinity.
- Provide necessary proposals for alterations to St Patrick's Rowing Club facilities following consultation with the club which will allow the construction & location of the bridge.
- Minimise disruption to local businesses, residents, water sports clubs and other public amenities.

1.1. St Patrick's Rowing Club

Local support for the scheme is a critical aspect of any planning application. Therefore, extensive consultations were undertaken with the St. Patrick's Rowing Club (SPRC) from the very outset of the project.

A summary of the results of these consultations is provided below as follows:

- SPRC are open to the prospect of relocating their club house so long as the location and the extent of facilities can be agreed. Any new facilities would have to be in the immediate vicinity of the existing club. SPRC would not be willing to relocate from Thorncastle Street or to merge with another boat club. They would object to any such proposals.
- If it is necessary to move the existing clubhouse, the preferred location would be at the water's edge just to the north of the existing clubhouse, facing the Liffey River, not the Dodder.
- The eastern riverbank of the river Dodder is very heavily silted up at present and the existing slipway at the end of Thorncastle Street is not suitable for the launching of boats. Therefore, any proposals to relocate to this area would be strongly opposed.
- SPRC have concerns about the potential for dramatic drops in membership due to the construction activities. Site hoardings to be carefully considered to ensure that members of the public are not intimidated by the site. Any construction work which could impact on the day-to-day activities of the SPRC would be carried out

during the wintertime. SPRC confirmed that they do not want the access to the clubhouse to be via the East Wall Road. The club is a major asset to the Ringsend community and they want to retain the "village" feel. Congestion on East Wall Road was the other major issue that they wanted to avoid.

Therefore, vehicular access to the rowing club will need to be maintained via Ringsend to allow for boat movements. A minimum vertical clearance of 10 feet would be required for delivering boats and equipment to the relocated club house. The movement of boats to / from the club house usually has a weekly frequency.

- If a new pedestrian access path was to be provided to a relocated club house SPRC would like consideration of it to be named as "Cassidy's Way".
- SPRC have currently several reserved parking spaces on Thorncastle Street. Any new facilities would need to maintain the same level of parking provision.
- SPRC indicated that the facilities available for the Poplar Rowing Club in London would be typical of the type of facility that they would anticipate.
- The existing jetty structure adjacent to the Tom Clarke Bridge is to be retained, albeit relocated as there is no other reliable means of accessing the river
- SPRC require, as a minimum, the equivalent facilities of the existing boat club. Compliance with the building regulations indicated an increased area would be required to address accessibility, child protection (segregated changing rooms, etc). The project architect developed a new layout indicating the size of the club house to be approximately 450m² to include for boat storage facilities on the ground floor with direct access to the river and increased recreational facilities on the upper floor where there is the potential for spectacular views over the river.
- The items in the grassed area between the East Wall Road and the River Dodder which were erected by SPRC (tourist signs, diving bell, anchor, etc) should be retained and reused in any landscaping plans for the area.
- SPRC would have no objections to the opening bridge control tower being incorporated into the re-located club house if necessary.

1.2. Kennedy Wilson

Kennedy Wilson are a key stakeholder in the project, as they own the land on the west side of the Dodder (Britain Quay / Sir John Rogerson's Quay) that will be impacted by the new bridge.

Their primary concerns revolve around land ownership, transfers, and accessibility for both pedestrians and vehicles to their Capital One development site as part of the project. Kennedy Wilson did have a few issues that related to the positioning of the Control building for the bridge which are summarised below;

- From discussion with Kennedy Wilson one of the main constraints are the levels at the boundaries of the development (approximately 30 metres from Britain Quay wall) which are not permitted to change. However, the levels of the public park amenity area between the development and the quay wall can be modified to suit the western bridge approach proposals.
- It is Kennedy Wilson's preference that the opening bridge control room is not located on Sir John Rogerson's Quay.

1.3. Land Availability

Based on the information on ground conditions currently available, the piers and abutment structures for the bridge will require piled foundations and to the east of the River Dodder, it is required to perform extensive land reclamation works in order to land the bridge. The issues around land availability and road alignment for the scheme are detailed within the Options Study Report. The need for significant land reclamation was determined based on these issues, the more significant of which are summarised below;

- The constraints imposed by existing structures, in particular the existing protected granite quay walls along Britain Quay and the 2008 Liffey Service Tunnel southern shaft which limits the available road alignment options.
- The existing land available at the Ringsend bridge site to construct the eastern Dodder Bridge approach and associated junction with the R131 is insufficient and substantial land reclamation would be required to the north of Thorncastle Street.
- The need for space for a contractor's compound as it is anticipated that storage and assembly of the structural elements will be undertaken in the lands north of the existing St. Patrick's Rowing Club.
- Sections of land on both the eastern bank at Ringsend and on the western bank of Sir John Rogerson's Quay are zoned as 'amenity' land. The proposed public transport priority bridge will have many positive impacts for the local community in terms of the provision of an additional new amenity area and improved connectivity and access to the area. In order to maintain the existing levels of amenity areas at this site DCC confirmed that it would be their preference that a new club house and new facilities for St Patrick's Rowing Club be provided on an area of reclaimed land on the eastern bank.
- The only public access / slipway to the Dodder/Liffey at this location is situated at the end of Thorncastle Street adjacent to the Portview Apartments. However, this access has been very heavily silted up for many years and is no longer suitable for the launching of boats. Carrying out remedial works to the existing slipway on Thorncastle Street would require ongoing, regular (most likely at annual) dredging of contaminated material. From discussions with Dublin Port this is not practical. The need for land reclamation as part of the scheme opens up the possibility for the provision of an additional public slipway directly into the Liffey and the associated positive impact that that would have for the local community.

2. CONCLUSIONS AND RECOMMENDATIONS

2.1. St Patrick's Rowing Club

Two possible locations are identified for the St Patrick's Rowing Club:

- Retain the existing building at the junction of Thorncastle Street and York Road.
- Provide a new St. Patrick's Boat House building adjacent to the river Liffey within the area of reclaimed land to the north of the site.

These options are discussed below.

Retain the Existing Building

It was imperative to the St Patricks Boat Club that they retain the location of the clubhouse in the centre of Ringsend as a focal point for the community with direct

access to the water. The primary issues over this option related to health and safety concerns about the need to cross a potentially busy road junction with large bulky equipment (21ft boats, etc) as well as the impacts that this option might have on the largely juvenile membership. A significant area of reclaimed land is needed at this location irrespective of whether the boat club is relocated or not to facilitate access for the pontoon, the road alignment and tie ins to the R131 and services relocations arising from the Liffey Services Tunnel. By not relocating the boat club building, the potential for significant conflict was highlighted between the public road, cycleways and pedestrians and the day-to-day activities of the club in an already congested location as the building would effectively become an island in the middle of a transport node surrounded by Thorncastle Street, York Road, the R131 and the new Dodder Bridge road.

Potential solutions to these issues were examined, including looking at the option of providing a dedicated underpass for the SPRC. However, constraints such as the limitations on the vertical alignment of the road, the proximity of the Thorncastle apartments and the required flooding design levels meant that these were not practical. Therefore, the option to retain the existing SPRC building at its existing position at the junction of Thorncastle Street and York Road was ruled out.

Provide a New St. Patrick's Boat House Building

The option to construct a new bespoke boatclub building was identified as the preferable option following examination of the constraints described above. The need for land reclamation and a new public slipway had already been flagged and the form of construction proposed for the land reclamation (piled reinforced concrete slab) was eminently suitable for a relatively light structure such as the boatclub.

A review of the existing facilities of the SPRC was carried out, and a proposal for the new boat house was defined, taking into consideration the requirements as described in the Options Report.

The following requirements for a new rowing club facility were developed, based on the current facilities available, and agreed with DCC.

- Internal storage for four wooden rowing boats. Each approx size 1.7m x 1.9m. 1m circulation required around each.
- Internal storage for an inflatable rig with outboard motor.
- Internal storage area to replace existing container lock up.
- Improved and enlarged changing facilities for men and women.
- Gymnasium approx 1.5 times the size of current.
- Social space approx 1.5 times the size of current, with bar and kitchen.
- Outdoor observation terrace parallel to and overlooking the Liffey.
- Boat club office.
- Male and female toilets.
- External secure area for trailer, and for overnight boat storage.
- Slipway directly into the River Liffey.
- Secure jetty and mooring as current size, located in Liffey with an east-west alignment.
- Replacement of all existing dedicated car parking spaces.

- To have a highly visible and eye-catching building that would help to raise the club profile.
- Ease of access to the boat club from Ringsend.

The primary factor determining the key dimension of the boat club building is the storage of rowing boats. These are approx. 7m in length and are rolled into the boat storeroom on a trailer. Once in place it is necessary to leave a 1m zone around the perimeter of each boat for circulation and for maintenance purposes. Plans and Elevations are provided as Figure 1.

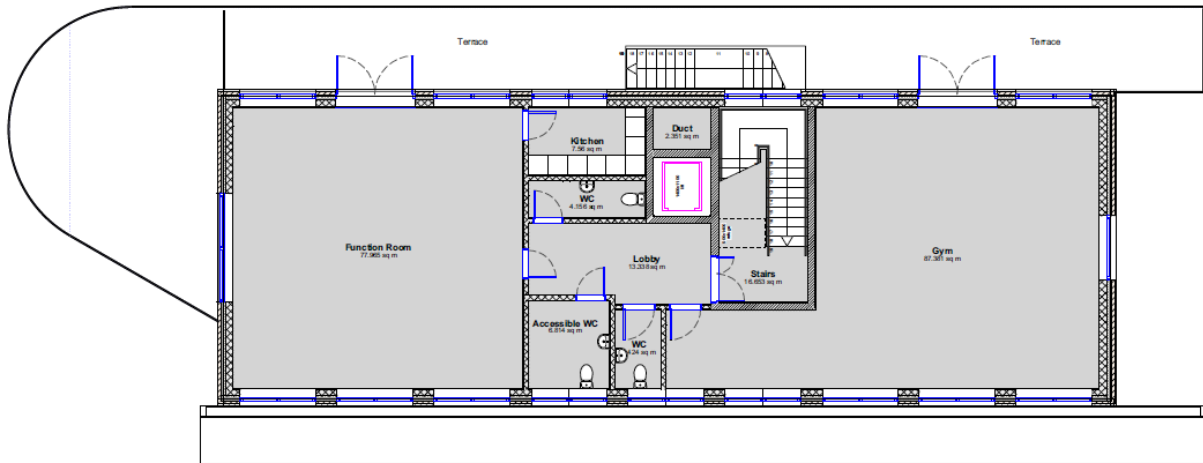

First Floor Plan

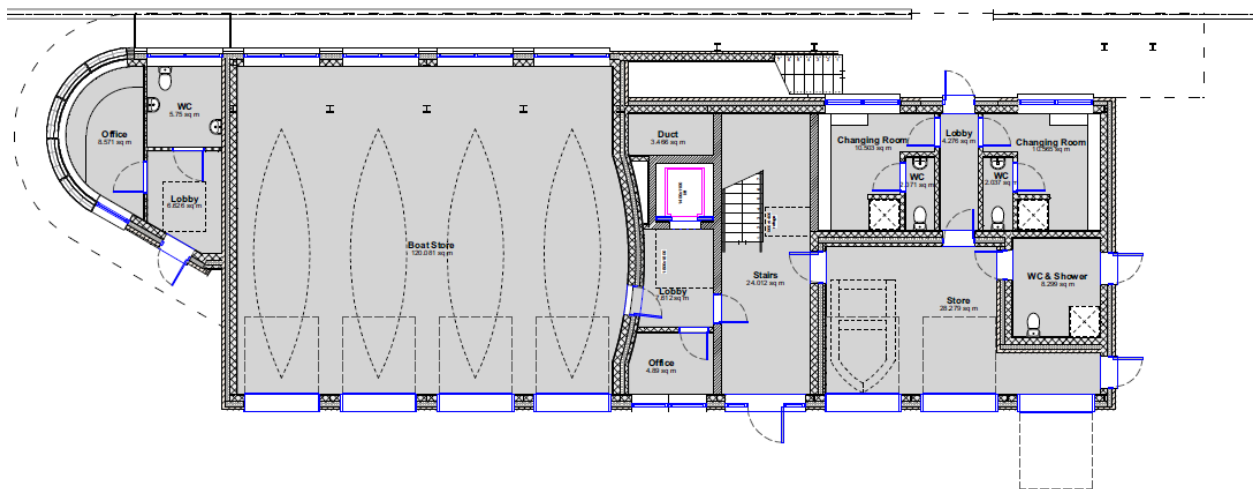

Ground Floor Plan



Figure 1

It is desirable to orientate the building parallel to the river Liffey, so that the view up and down the river and the jetty is maximised, and so the visual impact of the building (to help raise the profile of the club) is at its greatest. This would also assist the operational aspects of the club as it would facilitate better levels of oversight of the largely juvenile membership from the point of view of supervision and security.

2.2. Control Building

Two possible locations are identified for the opening bridge control building (see Figure 2 **Error! Reference source not found.**):

- At the corner of Sir John Rogerson's Quay / Britain Quay.
- As part of the new St. Patrick's Boat House building.

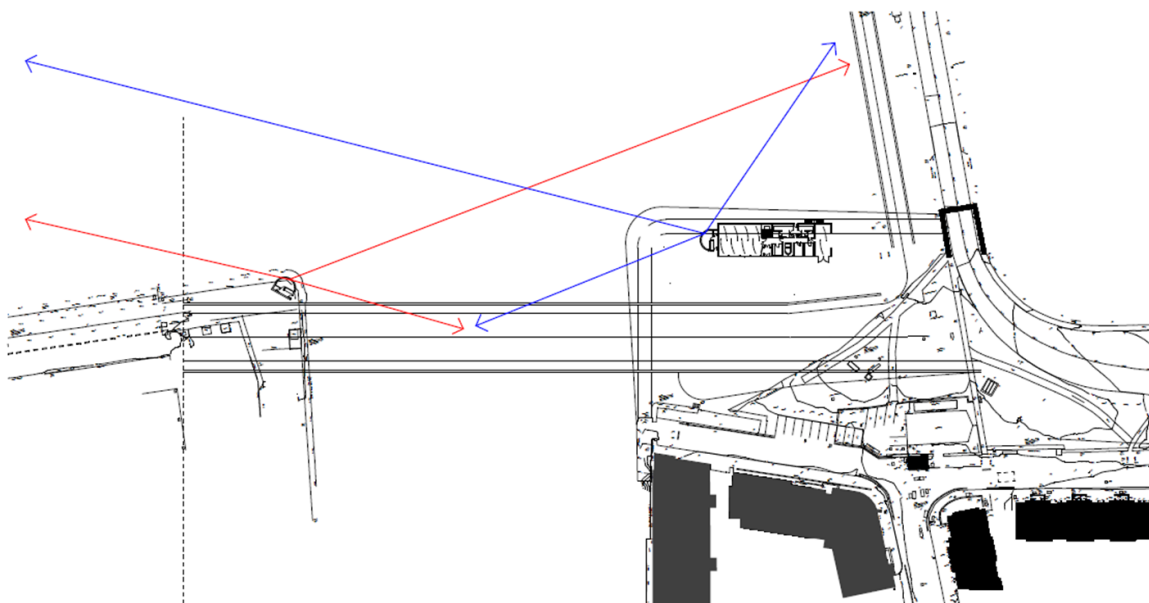

Figure 2

These options are discussed below.

Control Building at Sir John Rogerson's Quay / Britain Quay

Although the views from a control tower located at the corner of Sir John Rogerson's Quay / Britain Quay are closer to the navigation span of the Dodder Bridge, this option would require an additional separate power supply to the west of the river Dodder as well as sub-marine communication cabling to connect the control room to the bascule pier. It is also not a favourable option from the point of view of the possible congestion that can arise around the control room during future maintenance operations. The extra space available on the east side of the Dodder (or indeed along the fixed approach spans of the bridge) would be preferable for access for operation and maintenance.

Control Building adjacent to New Boat House

The second option – to provide a control building which is immediately adjacent to the new Rowing Club – is preferable. Views to the west and north are unrestricted for this option; views to the northeast are slightly restricted but have been deemed to be suitable for operational purposes. Refer to section Figure 2 regarding the constraints associated with the control building location (note that this drawing relates to the Options Study Stage and that design development for both the Control Building and Boat House has taken place since – see Figure 1 for current layouts which provides for improved views to the northeast).

The concept of providing a separate control building immediately adjacent to the relocated boat house has been initially agreed upon by representatives of St. Patrick's Rowing Club.

The option as proposed in Figure 1 provides for a separate control room adjacent to the proposed new club house building at the western end, located in a position with clear visibility of both the new bridge and of the approach path for vessels passing through the nearby Tom Clarke opening bridge (East Link).

The floor plan area of the proposed control building is taken as similar to that of the control building for the Samuel Beckett Bridge, at 22m². A hemispherical plan area is designed for the control building, with its flat face abutting the new St. Patrick's Rowing Club. A separate entrance is to be provided to the control building.

APPENDIX 9
SEA ACCESS OPTIONS FOR ST. PATRICK'S ROWING CLUB –
TECHNICAL NOTE



DODDER PUBLIC TRANSPORTATION OPENING BRIDGE

PRELIMINARY DESIGN REPORT | OCTOBER 2022



SEA ACCESS OPTIONS FOR ST. PATRICK'S ROWING CLUB – TECHNICAL NOTE



St. Patrick's Rowing Club, Ringsend

At the proposed location for the Dodder Public Transport Opening Bridge (DPTOB) on the east bank of the river there is a small area of public open space on the southeast corner of the confluence of the River Dodder and the River Liffey as shown in Image 3.8. The proposed public transport link road and cycleway to connect from the proposed new bridge (DPTOB) will extend across this open space to connect from Sir John Rogerson's Quay on the western side to the East Link Road on the eastern side as shown by the dashed red line on Image 3.8. Some land reclamation from the river is needed the road alignment and tie ins to the R131 on the eastern side of the new bridge, to facilitate access for the rowing club pontoon and to a new public slipway, and for services relocations arising from the Liffey Services Tunnel. The reclaimed area will also provide compensatory public open space to replace the area lost under the new road.

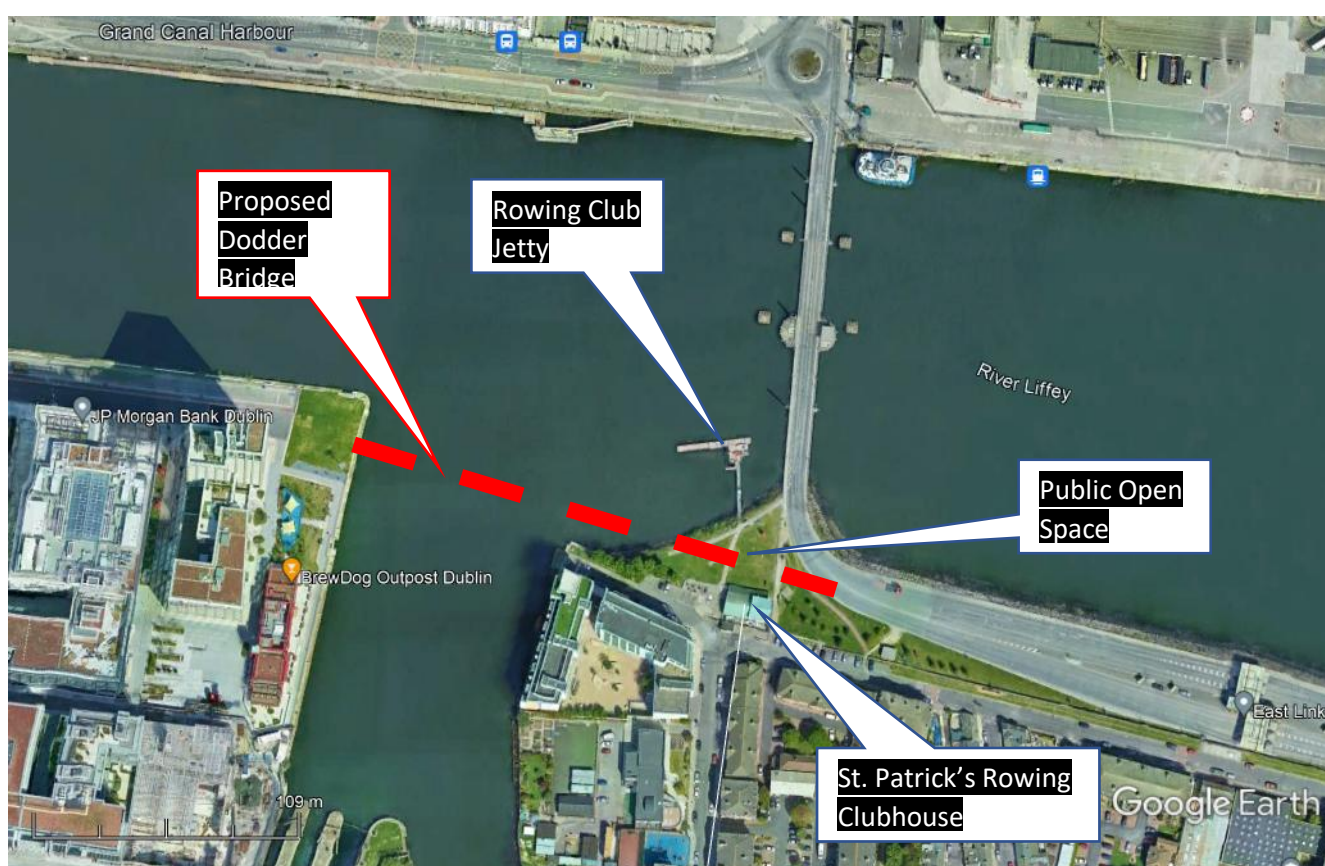

Image 8: Location of the Proposed Dodder Public Transport Opening Bridge

St. Patrick's Rowing Club is also located at the southeast corner of the confluence with the River Liffey and the River Dodder. There is a clubhouse on Thorncastle Street on the southern side of the public open space, and the jetty for access to the River Liffey is located on the northern side of the public open space area adjacent to Tom Clarke Bridge. The proposed link road to the new bridge (DPTOB) will pass between the clubhouse and the jetty which will impact on the operations of the rowing club by causing severance of the direct access to the river for the launching of boats that are stored in the clubhouse.

The following options were considered to address this situation as follows:

1. Retain the existing rowing club facilities in their current positions: This was ruled out for health and safety concerns about the need to cross a potentially busy road junction with large bulky equipment (21ft boats, etc), as well as the impacts that this option might have on the largely juvenile membership.
2. Retain the existing clubhouse and relocate the jetty and pontoon into the River Dodder to south of the proposed bridge: This is not feasible because the River Dodder is too shallow and could not provide a suitable launch location at low tide.
3. Retain the existing boat club facilities in their existing positions and provide an underpass connection: This is not feasible due to flood risk at high tides.
4. Relocate the clubhouse to north of the new link road nearer the River Liffey and jetty. This option is satisfactory for the operation of the boat club and avoids severance by the new road.

The proposed scheme will therefore require the relocation of the St. Patrick's Rowing Club building to a new location within the reclaimed land north of the proposed new link road for the River Dodder Public Transport Opening Bridge.

Control Room for the Dodder Public Transport Opening Bridge

A control room is required for the operation of the proposed Dodder Public Transport Opening Bridge, and this needs to be located in a position with clear visibility of both the new bridge and of the approach path for vessels passing through the nearby Tom Clarke opening bridge (East Link). The proposed location for the control room has been selected to meet this operational requirement and will be positioned to the northeast of the eastern end of the bridge. It will be located immediately adjoining the proposed location for the new clubhouse for St. Patrick's Rowing Club at the western end of the clubhouse so that there is a clear sightline to the Tom Clarke opening bridge.

APPENDIX 10
RIVER DODDER PUBLIC TRANSPORT OPENING BRIDGE –
MARITIME IMPACT ASSESSMENT



DODDER PUBLIC TRANSPORT OPENING BRIDGE

PRELIMINARY DESIGN REPORT | OCTOBER 2022



RIVER DODDER PUBLIC TRANSPORT OPENING BRIDGE – MARITIME IMPACT ASSESSMENT



Summary

1- Introduction.....	1
2- Scope	1
3- Data inputs and reviewed documents.....	2
4- Assessment of existing conditions in slipway and SPRC facilities	2
5- Assessment of predictable conditions in slipway and SPRC, after bridge and land reclamation construction	5
6- Conclusions	8

Ringsend to City Centre

Dodder Bridge - St Patrick's Rowing Club

Proposed Land Reclamation Area

Maritime Assessment Note

1- Introduction

Within BusConnects programme, the Ringsend to City Centre CBC Scheme includes the proposed River Dodder Public Transport Opening Bridge crossing. The proposed bridge will complete a new east-west connection for public transport, pedestrians, and cyclists across the mouth of the River Dodder from the eastern end of the south quays along the River Liffey to the Ringsend / Poolbeg Peninsula on the eastern side of the River Dodder. At the eastern end of the new bridge an area of land will be reclaimed at the south-eastern corner of the confluence of the two rivers to carry the new link road from the bridge across an area of tidal mud-flats to link with the East Link Road at the southern end of Tom Clarke Bridge.

As a consequence of the new bridge project, the existing Saint Patrick's Rowing Club (SPRC) facilities will be isolated from direct access to the River Liffey and adjustments are necessary to provide suitable alternative access for the rowing club to the river. A new building will be constructed for the rowing club to the north of the proposed new link road on an area of land to be reclaimed from the river (with a piled structure), and the existing pontoon in the River Liffey will be relocated on the north side of this area.

The existing public slipway to the eastern side of the mouth of the River Dodder is situated at the end of Thorncastle Street, where it is only functional at high tide. This will be substituted by a new slipway, to be constructed from the same piled structure, next to the SPRC new building with direct access to the River Liffey channel at low tide, which will improve access to the river for the public.

2- Scope

This technical note provides a maritime assessment of the proposed relocation of the SPRC maritime facilities and the public slipway. This report provides a high-level analysis of the existing facilities and compares the existing conditions with the predictable future ones for the proposed layout of the Dodder Public Transport Opening Bridge.

3- Options

The following options were considered to address the provisions for access to the river in the vicinity of the proposed new bridge as follows:

1. Retain the existing rowing club facilities in their current positions: This was ruled out for health and safety concerns about the need to cross a potentially busy road junction with large bulky equipment (21ft boats, etc), as well as the impacts that this option might have on the largely juvenile membership.

2. Relocate the jetty into the River Dodder to south of the proposed bridge: This is not feasible because the River Dodder is too shallow and could not provide a suitable launch location at low tide.
3. An underpass connection: This is not feasible due to flood risk at high tides.
4. Relocate the boathouse to north of the new link road nearer the River Liffey and jetty. This option is satisfactory for the operation of the boat club and avoids severance by the new road.

4- Data inputs and reviewed documents

This report has been developed using the information and analyses included in the following documents:

- Drawings:
 - BCIDD-ROT-STR_ZZ-0016_XX_00-DR-SS-0009 Status A Rev.M01
 - BCIDD-ROT-STR_ZZ-0016_XX_00-DR-SS-0016 Status A Rev.M01
 - BCIDD-ROT-STR_ZZ-0016_XX_00-DR-SS-0017 Status A Rev.M01
 - BCIDD-ROT-STR_ZZ-0016_XX_00-DR-SS-0018 Status A Rev.M01
- DPTB-ROD-C1-SWE-RPT-CV-000-04 Boat Club Feasibility Rpt.pdf, title “St Patrick’s Rowing Club Feasibility Report| June 2022 DPTB-ROD-C1-SWE-RPT-PM-00029-04”
- Hydrodynamic_report_fdraft_v3.docx, title “Hydrodynamic modelling of the Dodder Estuary to Assess Scour impact of the Proposed Dodder Bridge Development at Ringsend Dublin”.

5- Assessment of existing conditions in slipway and SPRC facilities

The analysed documents refer to a land reclamation area, designed as a piled platform, integrating the new aforementioned slipway and the new SPRC building and facilities:

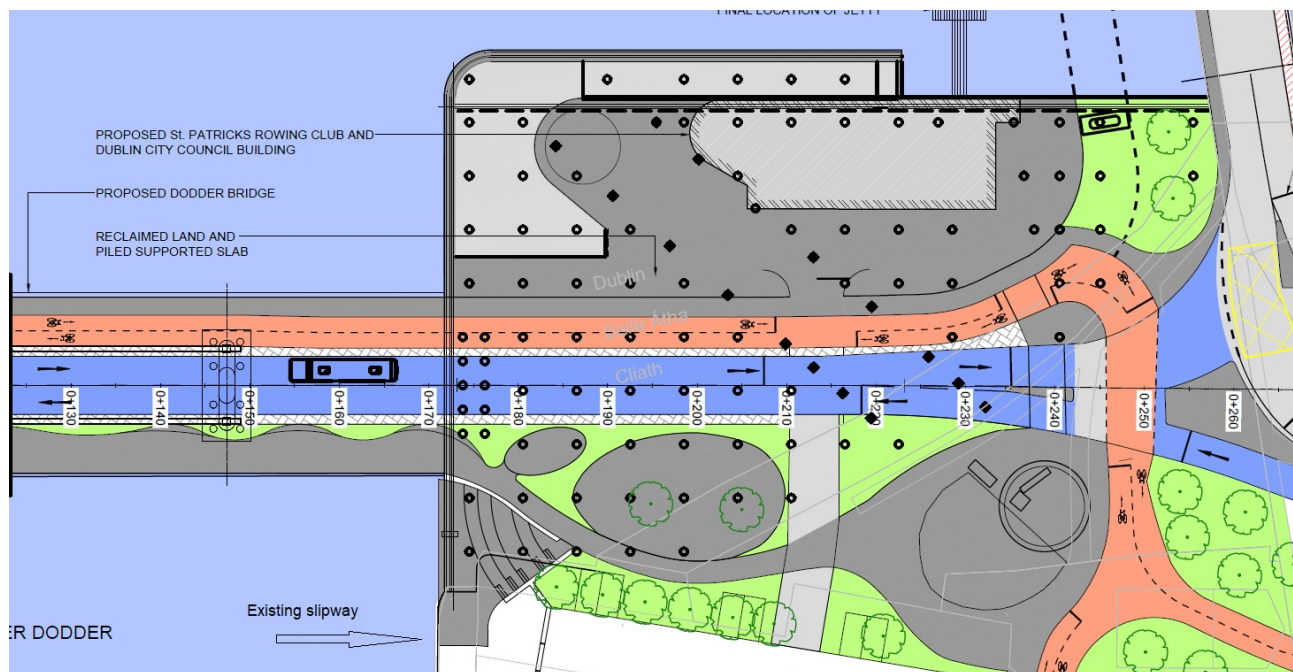

Detail of drawing BCIDD-ROT-STR_ZZ-0016_XX_00-DR-SS-0009

The planned land reclamation occupies, roughly, the low draught areas due to the siltation, as can be seen in the following pictures:



Bathymetry. Source: Navionics.



Satellite photo. Source: Google Earth (June 2020)

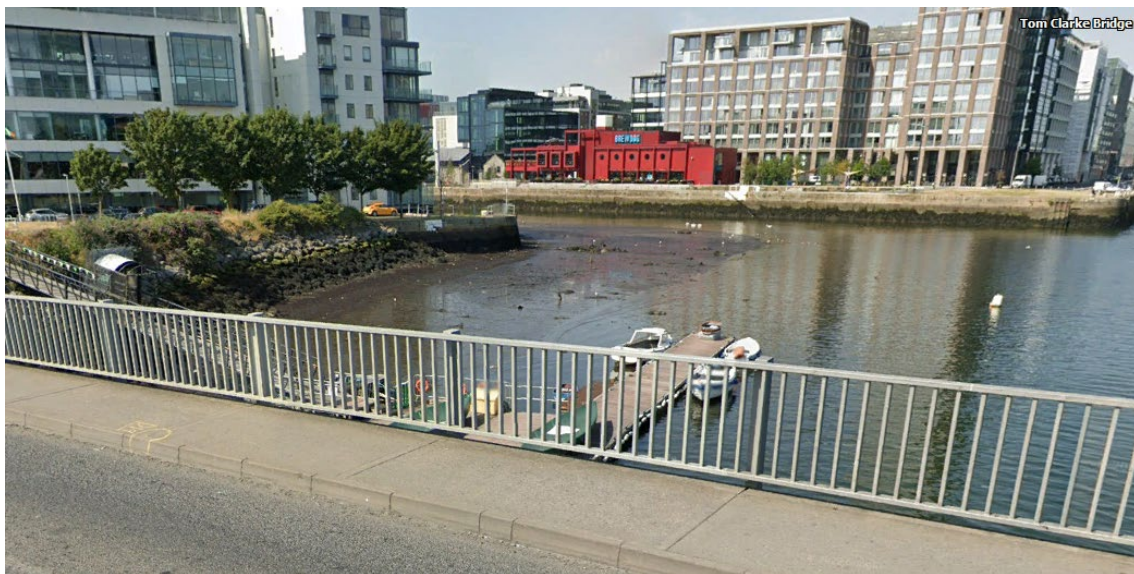

View from Tom Clarke Bridge to SPRC/slipway area. Source: Google Streetview (July 2022)

The operation on the existing public access slipway on a regular basis is difficult, and ruled by the tides level. This is because that area is affected by strong siltation issues, and many hours per day it cannot be safely used to access with boats to the river. A solution to this problem would be periodic maintenance dredging, but that solution is not accepted by Dublin Port as the material might be contaminated (see “*St Patrick’s Rowing Club Feasibility Report| June 2022 DPTB-ROD-C1-SWE-RPT-PM-00029-04*”, page 5). So, the best solution to this problem is to construct a new public slipway to access the Liffey river, avoiding shallow waters.

Regarding the operation of the SPRC, the existing pontoon is located in areas with depths around (-2m... -1m) range, enough for small boats and kayaks, even on low tide, as can be seen in the following picture:

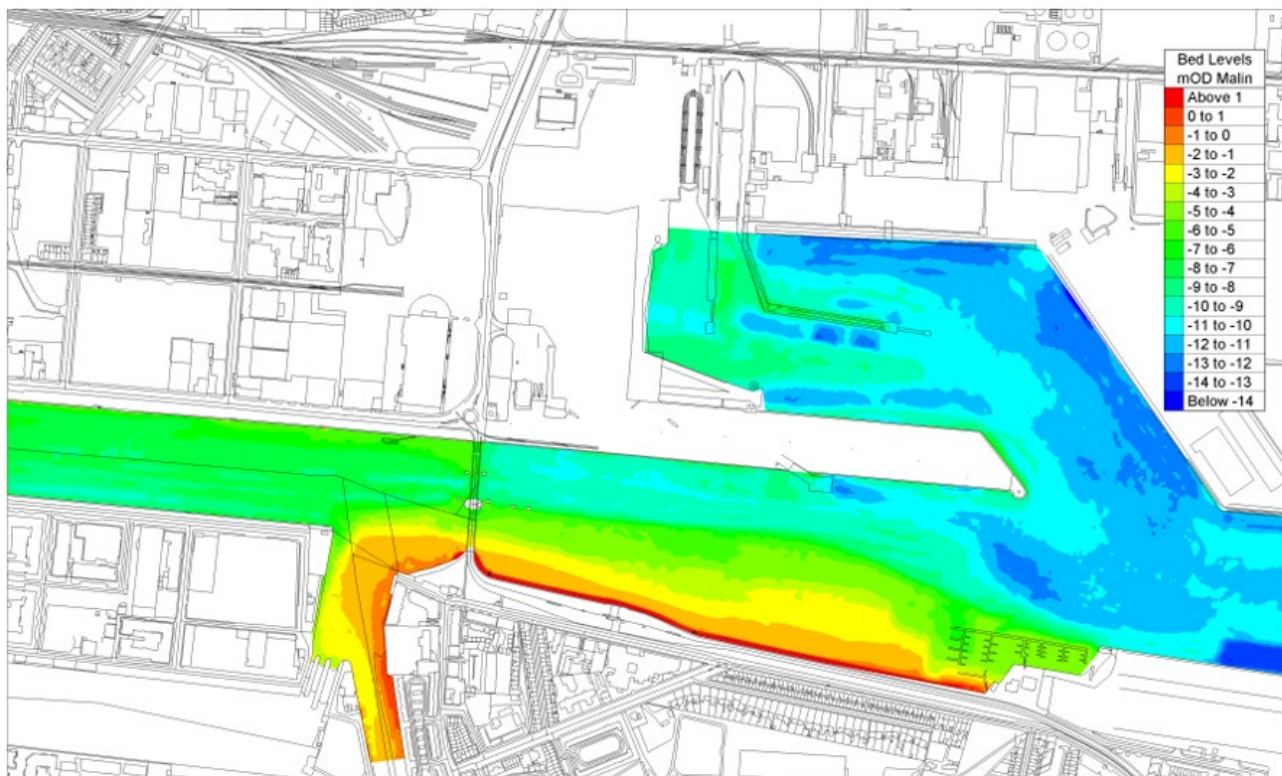

Nowadays no issues with siltation seem to exist; the main (non-critical) problem may be the distance from the building to the water line. Anyway, the future construction of the new road would worsen the access from the building to the water, as can be read in the document “*St Patrick’s Rowing Club Feasibility Report June 2022 DPTB-ROD-C1-SWE-RPT-PM-00029-04*”; in fact, this is the main reason to the new location for the SPRC building on the piled structure.

6- Assessment of predictable conditions in slipway and SPRC, after bridge and land reclamation construction

From the maritime point of view, three main aspects should be analysed to understand the predictable functionality of the future structures and facilities:

- Impact on hydrodynamics of the area due to the new piled structure;
- Impact due to changes on the location of the public access slipway;
- Impact on the SPRC operation.

Impact in hydrodynamics of the area due to the new piled structure.

The impact on the rivers’ behaviour has been comprehensively studied in the document *Hydrodynamic_report_fdraft_v3.docx*, title “Hydrodynamic modelling of the Dodder Estuary to Assess Scour impact of the Proposed Dodder Bridge Development at Ringsend Dublin”. Exhaustive analysis of the content of this document is considered out of the scope of this technical note, and is assumed to be correct.

The conclusions of this report are copied here:

The conclusion from this hydrodynamic analysis is that under normal tide and fluvial flow conditions the impact of the proposed development both the bridge crossing and Rowing Club facility will not result in any significant effect either on the hydrodynamics or the morphology of the Liffey and Dodder channels. A localised effect on hydrodynamics will occur at the proposed bridge crossing site adjacent to the proposed piers during flood events. This is likely to give rise to some potential local scouring along the eastern bank of the Dodder as a result of deflection of flow by the proposed Bascule pier. The effect of this is localised to the immediate vicinity of the proposed bridge and western and northern side of the Rowing Club Site. These flood events are rare and short lived and will result in only localised changes to the potential scouring pattern with no significant morphological impacts identified downstream.

The overall conclusion reached is that the proposed Dodder Bridge development will not give rise to significant hydrodynamic or morphological changes in the Liffey reach downstream of the Tom Clarke Bridge.

As a first comment, the fact of have predictable “(...) *potential local scouring along the eastern bank of the Dodder*” is not considered a risk for the land reclamation, as this is designed as a piled structure, so -normal-scouring near the piles will not affect the structural stability.

To consider potential changes on operativity on the structures, as it can be seen in the hydrodynamical study, the most frequent comparison of the situation between before and after considering the effects of the new bridge and land reclamation, is similar to this picture :

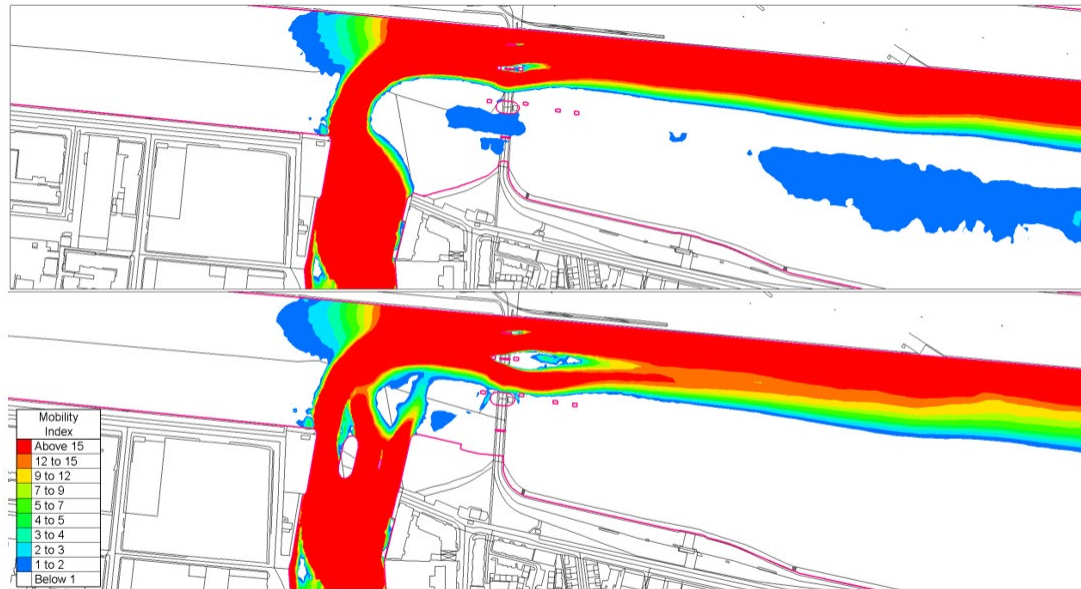

Figure 63 Computed Silt Mobility Map at Mid-Flood for existing and proposed cases – Simulation 6 (Mobility Index < 1 silt is not mobile)

The picture shows the siltation index, as a result of the changes in velocity of the river, in a particular scenario (simulation 6). The existing slipway is not affected (as it is upstream the new bridge); the land reclamation area (piled structure) shows some changes in its western wall, but not in the northern one (i.e. the area to be used for the new slipway and SPRC pontoon).

In other scenarios, the results are similar, so (as per the hydrodynamic study) no major effects on the rivers' behaviour are foreseeable due to the construction of the new bridge and the piled structure.

Impact due to changes on the location of the public access slipway

As shown in the previous section, the existing slipway cannot be used properly due to siltation.

The new location, on the north side of the land reclamation (piled structure), has better conditions in terms of draught, even in extreme low tide (river bed level: -2.5m approx.; MLWS: -1.8m):

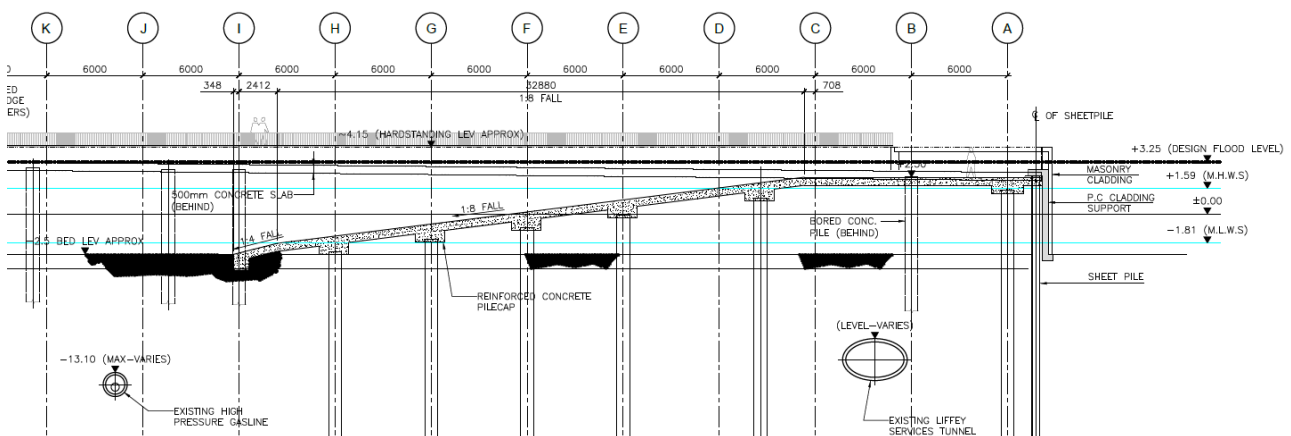

Detail extracted from drawing "BCIDD-ROT-STR_ZZ-0016_XX_00-DR-SS-0017"

So, the usability of the new slipway will be substantially improved, when compared to the existing one at the end of Thorncastle Street.

Impact on the SPRC operation

The SPRC facilities would be located over the piled structure, and the existing pontoon will be relocated, as can be seen on the following picture:

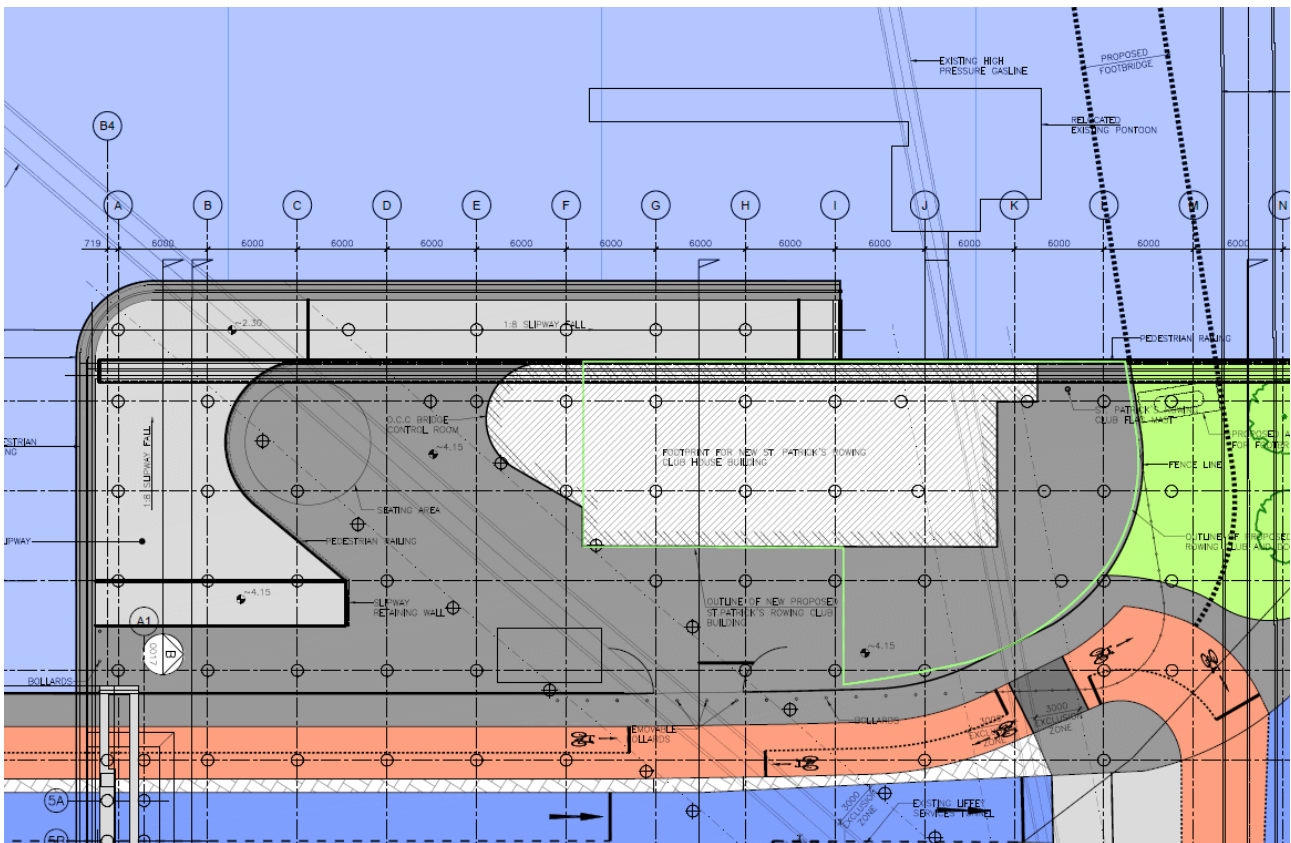

Detail extracted from drawing "BCIDD-ROT-STR_ZZ-0016_XX_00-DR-SS-0016"

The new location for the building is very close to the edge of the piled structure; the panoramic view from the building to the river will be substantially improved, including the surveillance capabilities to the boats at the pontoon, people practising rowing in the river, etc. (as mentioned in document "St Patrick's Rowing Club Feasibility Report| June 2022 DPTB-ROD-C1-SWE-RPT-PM-00029-04" "(...) This would also assist the operational aspects of the club as it would facilitate better levels of oversight of the largely juvenile membership from the point of view of supervision and security.")

On the other hand, the tip of the new slipway seems to be very close to the future position of the re-located pontoon, at least as shown in the picture above. This is true just for extreme low tides periods, but as can be seen in drawing "BCIDD-ROT-STR_ZZ-0016_XX_00-DR-SS-0017" (see detail in previous section), that distance increases with normal tides and usability of the ramp would not be usually affected. Anyway, SPRC should verify to achieve a safe design, with enough vertical clearance and horizontal distances, for the new connection walkway from the shore to the pontoon on its new location.

7- Conclusions

- a) The effects of the new structures (bridge and piled structure for land reclamation) in the behaviour of the rivers Liffey and Dodder have been studied in a comprehensive hydrodynamical study (performed by others). No critical changes in water velocity and siltation are foreseen, as per the mentioned study, and scouring will not affect the stability of the piled structure.
- b) The usability of the public access slipway will be noticeably improved, in terms of operativity (number of hours when the facility can be used). Nowadays, the existing location is not adequate for its regular use. This is considered a positive impact of the Dodder Bridge Project, for the local community.
- c) The SPRC will enjoy a better location of its building, very close to the waterline. When they analyse the new location for their private pontoon, some basic safety considerations should be taken in account by SPRC, to assure compatible use between their pontoon and the public access slipway.